

MAHR SPOTLIGHTS

All Products Available For Fast Delivery!



HAND TOOLS AND BORE GAGES PROMOTION

PROMOTION PRICES VALID UNTIL
12/31/2013



- 0 +



EXACTLY



Scan for
PDF version

MarCal. The new Generation of digital calipers with the Reference-System WATERPROOF CALIPERS

Lapped guideways for superior performance

Only MarCal calipers have lapped guideway surfaces, these guarantee an even and sensitive run of the slide. Additionally, the service life of the caliper increases compared to a ground guideway due to the greater contact area on the guideway surface.

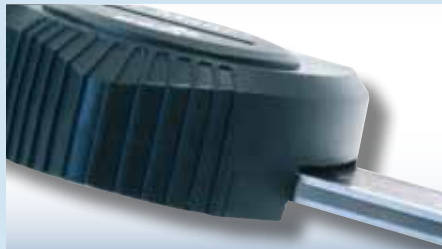

Surface of the guideway

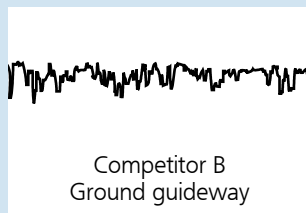
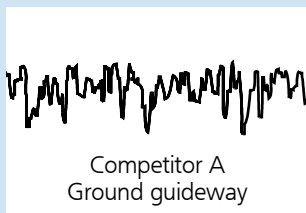
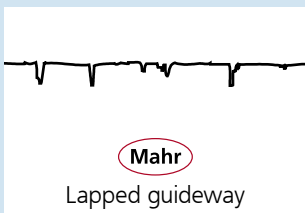

Complete Line
Full Feature Digital

50% longer battery lifetime

The new Reference system is extremely energy efficient as when the caliper is in standby mode; almost no power is required, thus extending the life of the battery to up to 50%.

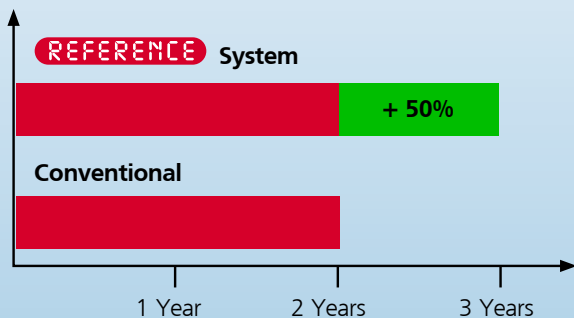

Security due to the Reference-Lock function

- Zero-position is secured
- Operating error is not possible

The Digital Caliper MarCal 16 EWR Reference is equipped with a LOCK function. With this key lock, the zero position is secured and operating error is avoided.



MarCal - The innovative Reference-System

Just set reference once

All Mahr digital calipers with this logo **REFERENCE** are equipped with zero position just has to be set once: after setting the zero position, the zero reference is stored. Therefore, once the caliper is switched ON or the slide is moved, the caliper is in the zero position. No need to reset to zero with a conventional caliper once the caliper is switched ON.

REFERENCE System

- ① Switch ON

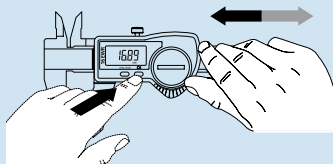

Line of Digital Calipers



List Price
\$179.00
Promo Price
\$135.00

The only one with a universal MarConnect interface

Regardless of which evaluation device you are using, with a MarConnect interface you always have the optimal connection.



USB ready: For direct connection to a PC when using our MarCom software you can transfer your measured values directly into MS Excel or with a keyboard code into any application.



Digimatic: To connect to Digimatic compatible evaluation devices.



Mahr Opto RS232C: To connect to the COM interface on a PC.

Ergonomic Design

The handy non-slip thumb support of the MarCal 16 EWR ensures even in contaminated working conditions trouble-free handling and therefore reliable measuring results.



The high-contrast display with 8.5 mm high digits enables accurate, fatigue-free reading of the measurement results.

Excellent resistance against dust, coolant and lubricants



Due to the outstanding protection against dust and water, the Digital Caliper MarCal 16 EWR Reference delivers precise and secure results even in the most difficult workshop conditions.



h the innovative Reference-System. The
ains stored for all further measurements.
Immediately ready for measurement. The
on has now become obsolete.

② Result of measurement

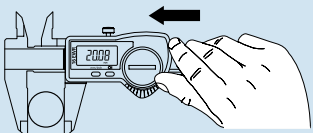

Code Initials	IP	International Protection
First digit	6	Dust-tight
Second digit	7	Protected against temporary immersion in water

Get a free 16 ER caliper with purchase of selected gages

▶ | This end of year promotion brochure is loaded with many products carrying a **Free Caliper Symbol** as seen here. When you order a product with the Free Caliper Symbol from this brochure - by the special order number specified, you will also receive one free **16 ER** - our newest and performance packed caliper, order number **4103002**. The values in this brochure are hot, but when combined with the free 16 ER they are untouchable! Order yours today. | ◀

MarCal Digital Caliper 16 EWR with Reference System, Protection Class IP67

-
-
-
-



List Price
\$179.00
Promo Price
\$135.00
Order no. 4103060P

Functions:

- ON/OFF, RESET (Set display to zero), mm/inch, Reference-Lock/Unlock, Auto-ON/OFF
- Immediate measurement due to the **Reference system**
- Excellent resistance against dust, coolants and lubricants, **Protection Class IP67**
- Life of the battery up to **3 years**
- High contrast Liquid Crystal Display with 8.5 mm high digits
- Lapped guideway



For further detailed information see:
www.mahr.com
WebCode 13526-11250

	Measuring range	Resolution	Depth rod	Friction Wheel	Order no.	List Price	Promo Price
	mm (inch)	mm / inch					
16 EWR	150 (6")	0.01 / .0005"	●		4103060P	\$179.00	\$135.00
16 EWR	150 (6")	0.01 / .0005"		●	4103062P	\$179.00	\$135.00
16 EWR	150 (6")	0.01 / .0005"	●	●	4103061P	\$179.00	\$135.00
16 EWR	150 (6")	0.01 / .0005"		●	4103063P	\$179.00	\$135.00

MarCal Digital Caliper 16 EWR with Reference System, Protection Class IP67 and Output



List Price From
\$214.00
Promo Price From
\$165.00

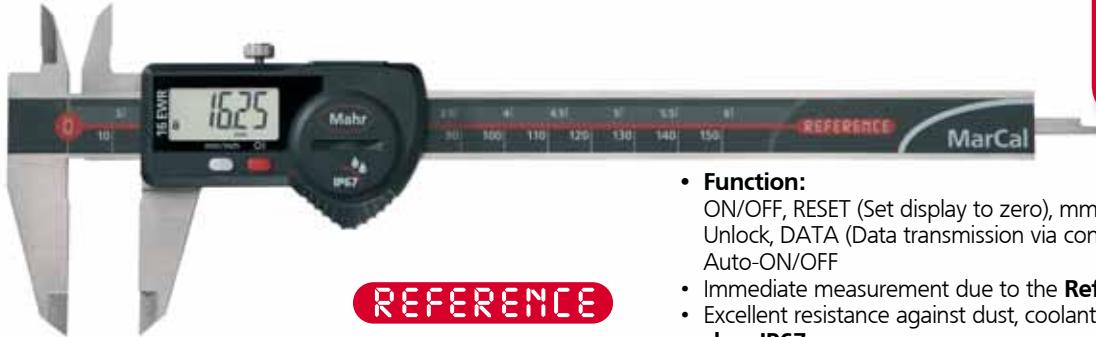

REFERENCE

- **Function:** ON/OFF, RESET (Set display to zero), mm/inch, Reference-Lock/Unlock, DATA (Data transmission via connection cable), Auto-ON/OFF
- Immediate measurement due to the **Reference system**
- Excellent resistance against dust, coolants and lubricants, **protection class IP67**
- **MarConnect** data output, choose alternatively: USB, OPTO RS232C or Digimatic
- Life of the battery up to **3 years**
- High contrast Liquid Crystal Display with 8.5 mm high digits
- Measuring blades for inside measurement



For further detailed information see:
www.mahr.com
WebCode 2553

	Measuring Range		Resolution mm / inch	Error Limit G mm / inch	Depth Rod		Friction Wheel	Order no.	List price	Promo price
	mm	(inch)								
16 EWR	150	(6")	0.01 / 0.0005"	0.03 / 0.001"	●			4103064P	\$214.00	\$165.00
16 EWR	150	(6")	0.01 / 0.0005"	0.03 / 0.001"		●		4103066P	\$214.00	\$165.00
16 EWR	150	(6")	0.01 / 0.0005"	0.03 / 0.001"	●		●	4103065P	\$214.00	\$165.00
16 EWR	150	(6")	0.01 / 0.0005"	0.03 / 0.001"			●	4103067P	\$214.00	\$165.00
16 EWR	200	(8")	0.01 / 0.0005"	0.03 / 0.001"			●	4103068P	\$248.00	\$191.00
16 EWR	200	(8")	0.01 / 0.0005"	0.03 / 0.001"		●	●	4103069P	\$276.00	\$199.00
16 EWR	300	(12")	0.01 / 0.0005"	0.04 / 0.0015"				4103070P	\$371.00	\$286.00
16 EWR	300	(12")	0.01 / 0.0005"	0.04 / 0.0015"			●	4103071P	\$420.00	\$295.00

MarCal. Digital Caliper 16 ER with Reference System and Output

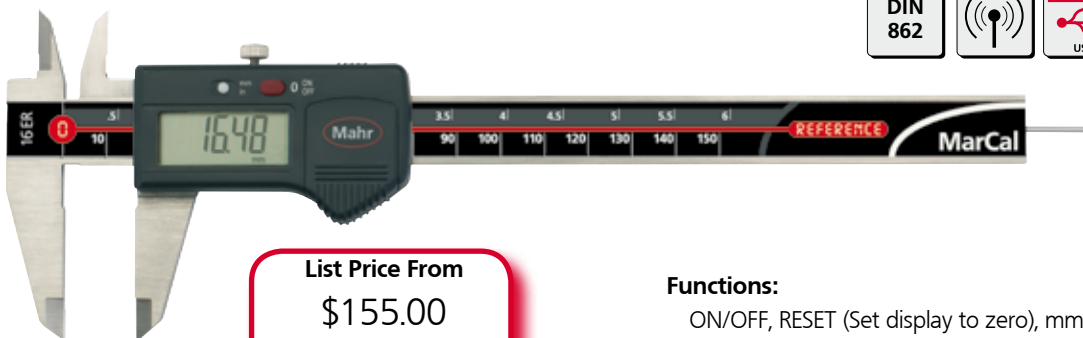

List Price From
\$155.00
Promo Price From
\$118.00

- Functions:**
- ON/OFF, RESET (Set display to zero), mm/inch, Reference-Lock/Unlock, Auto-ON/OFF
 - Immediate measurement due to the **Reference system**
 - **MarConnect** data output, choose alternatively: USB, OPTO RS232C or Digimatic
 - Life of the battery up to **3 years**
 - High contrast Liquid Crystal Display with 8.5 mm high digits
 - Beam and crossbeam are made of hardened stainless steel



For further detailed information see:
www.mahr.com
WebCode 2184

	Measuring range		Resolution mm / inch	Error limit G mm / inch	Depth Rod		Order no.	List price	Promo price
	mm	(inch)							
16 ER	150	(6")	0.01 / 0.0005"	0.03 / 0.001"	●	●	4103002P	\$155.00	\$118.00
16 ER	150	(6")	0.01 / 0.0005"	0.03 / 0.001"	●		4103003P	\$155.00	\$118.00
16 ER	200	(8")	0.01 / 0.0005"	0.03 / 0.001"	●		4103004P	\$210.00	\$147.00
16 ER	300	(12")	0.01 / 0.0005"	0.04 / 0.0015"			4103005P	\$330.00	\$229.00

MarCal. 16 EWR scribing or blade calipers

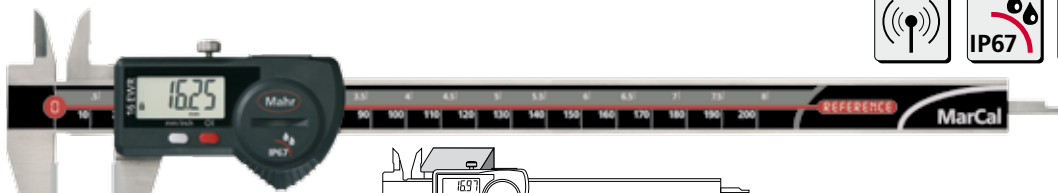

16 EWR-AR

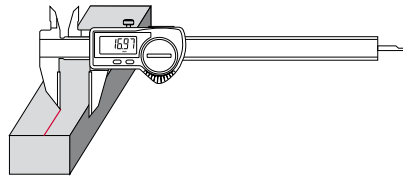

REFERENCE

List Price
\$445.00
Promo Price
\$335.00

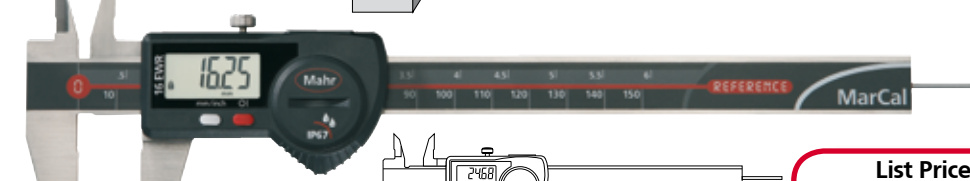

16 EWR-NA

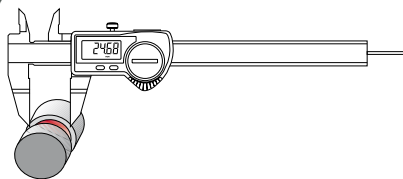

List Price
\$891.00
Promo Price
\$680.00

- Features**
- Features are the same as the MarCal 16 EWR
 - The thin blade jaws fit into very small grooves

Technical Data

	Type	Measuring range		Resolution	Error limit G	Depth rod	Order no.	List price	Promo price
		mm	(inch)						
16 EWR-AR	Scribing/marketing caliper	200	(8")	0.01 / 0.0005"	0.03	•	4103082P	\$445.00	\$335.00
16 EWR-NA	Keyseat caliper	150	(6")	0.01 / 0.0005"	0.03	•	4103074P	\$891.00	\$680.00

MarCal 16 EWR pointed calipers



16 EWR-S

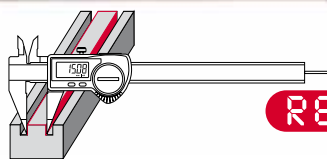

REFERENCE

List Price
\$611.00
Promo Price
\$465.00



16 EWR-SM

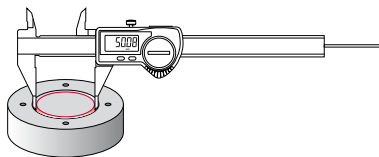

List Price
\$686.00
Promo Price
\$520.00

- Features**
- Features are the same as the MarCal 16 EWR
 - Narrow tip jaws fit into very small grooves and tracks

Technical Data

	Type	Measuring range		Resolution	Error limit G	Depth rod	Order no.	List price	Promo price
		mm	(inch)						
16 EWR-S	Pointed caliper	150	(6")	0.01 / 0.0005"	0.03	•	4103075P	\$611.00	\$465.00
16 EWR-SM	Caliper with pointed measuring jaws	150	(6")	0.01 / 0.0005"	0.03	•	4103076P	\$686.00	\$520.00

MarCal 16 EWR offset centerline caliper

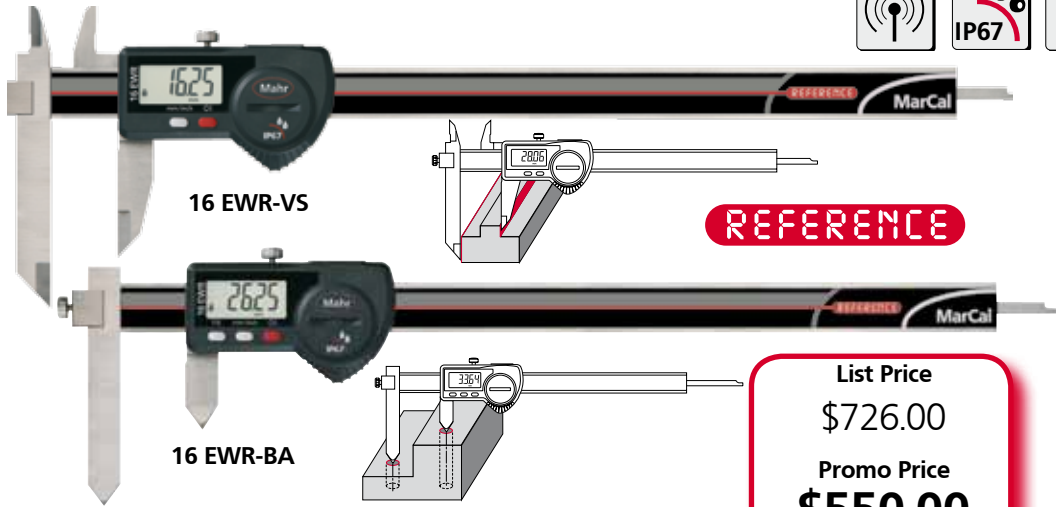
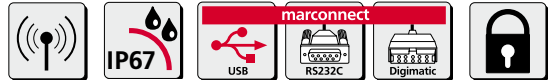

16 EWR-VS

16 EWR-BA

REFERENCE

List Price
\$773.00
Promo Price
\$580.00

List Price
\$726.00
Promo Price
\$550.00

Features

- Features are the same as the MarCal 16 EWR
- Main jaw is adjustable for height and easy alignment

Technical Data

	Type	Measuring range		Resolution	Error limit G	Depth rod	Order no.	List price	Promo price
		mm	(inch)						
16 EWR-VS	Adjustable measuring jaws	0 - 200	(0 - 8")	0.01/ 0.0005"	0.03	●	4103083P	\$773.00	\$580.00
16 EWR-BA	Adjustable measuring jaws*	10 - 210	(0.4 - 8.3")	0.01/ 0.0005"	0.03	●	4103084P	\$726.00	\$550.00

* to measure the distance between bores

MarCal 16 EWR inward neck caliper

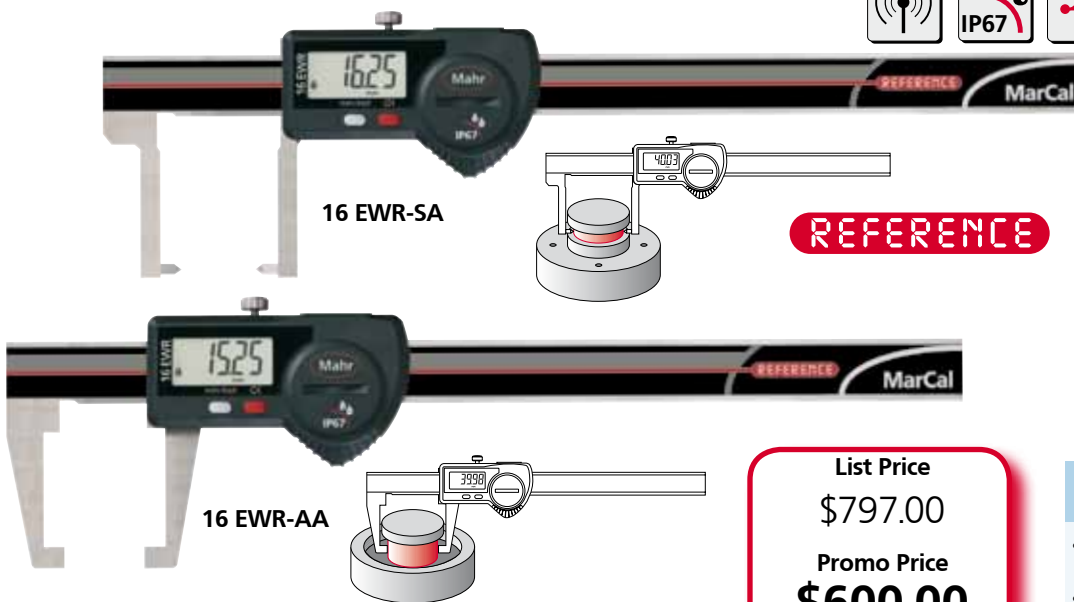

16 EWR-SA

16 EWR-AA

REFERENCE

List Price
\$936.00
Promo Price
\$710.00

List Price
\$797.00
Promo Price
\$600.00

Features

- Features are the same as the MarCal 16 EWR
- For grooves and recesses

Technical Data

	Type	Measuring range		Resolution	Error limit G	Order no.	List price	Promo price
		mm	(inch)					
16 EWR-SA	Inward angled contacts	150	(6")	0.01/ 0.0005"	0.03	4103077P	\$936.00	\$710.00
16 EWR-AA	Inward angled jaws	150	(6")	0.01/ 0.0005"	0.03	4103079P	\$797.00	\$600.00

MarCal 16 EWR outward neck caliper

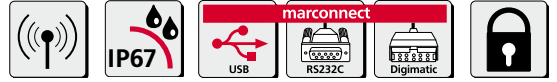

REFERENCE

List Price
\$920.00
Promo Price
\$699.00

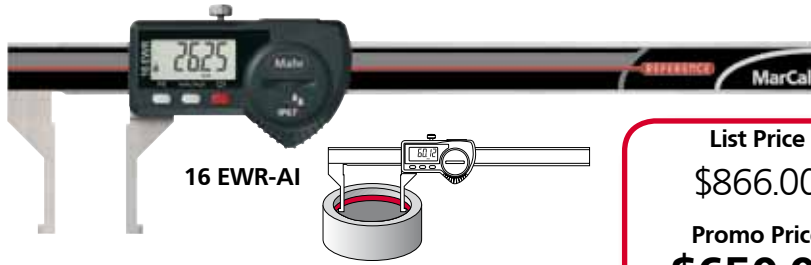

List Price
\$866.00
Promo Price
\$650.00

- Features**
- Features are the same as the MarCal 16 EWR
 - Specially designed for inside measurements

Technical Data

	Type	Measuring range		Resolution	Error limit G	Order no.	List price	Promo price
		mm	(inch)					
16 EWR-SI	Outward angled contacts	20 - 170	(0.8 - 6.7")	0.01/ 0.0005"	0.03	4103078P	\$920.00	\$699.00
16 EWR-AI	Outward angled jaws	10 - 160	(0.4 - 6.3")	0.01/ 0.0005"	0.03	4103080P	\$866.00	\$650.00

MarCal 16 EWR wall thickness or knife edge caliper

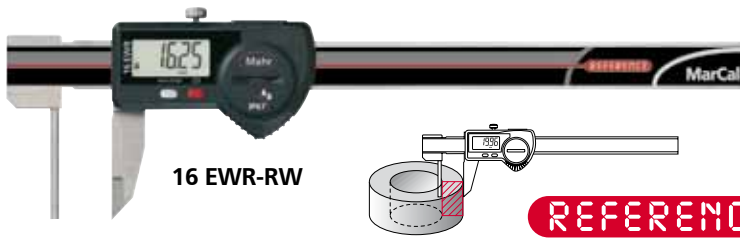

REFERENCE

List Price
\$774.00
Promo Price
\$589.00

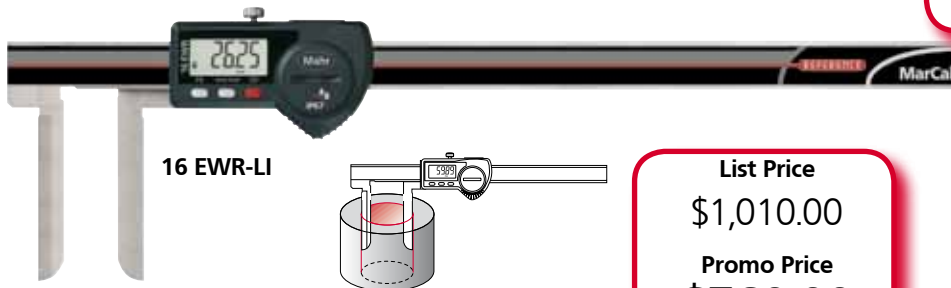

List Price
\$1,010.00
Promo Price
\$760.00

- Features**
- Features are the same as the MarCal 16 EWR
 - Main scale jaw is round bar for measuring tube wall thickness

Technical Data

	Type	Measuring range		Resolution	Error limit G	Order no.	List price	Promo price
		mm	(inch)					
16 EWR-RW	Wall thickness measuring caliper	0 - 150	(0 - 6")	0.01/ 0.0005"	0.05	4103081P	\$774.00	\$589.00
16 EWR-LI	With long narrow measuring jaws	10 - 200	(0.4 - 8")	0.01/ 0.0005"	0.05	4103085P	\$1,010.00	\$760.00

Universal Digital Caliper MarCal 16 EWW in set

REFERENCE

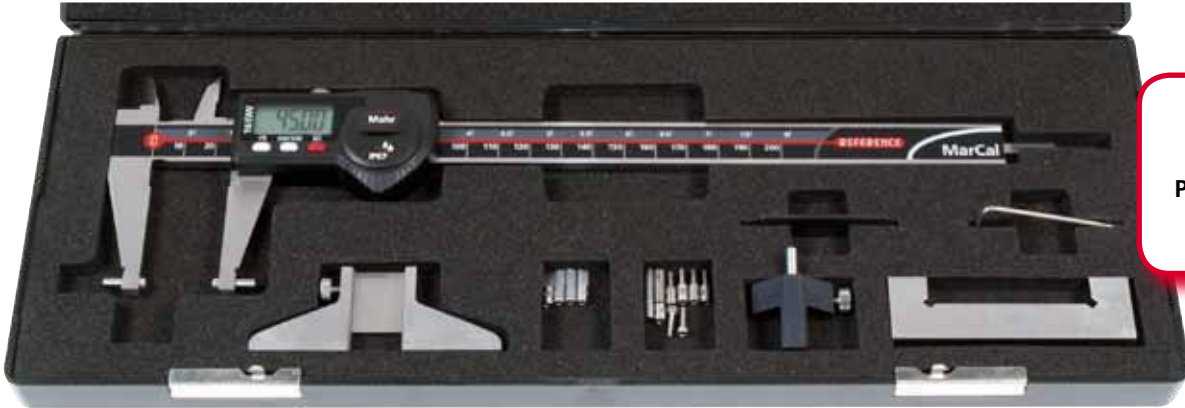
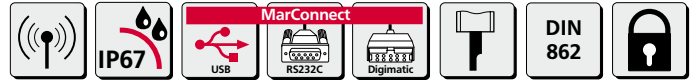

List Price From
\$567.00
Promo Price From
\$482.00

Applications

- The 16 EWW can also be used as a standard caliper (4 types of measurement).

When used in conjunction with the standard accessories; it is possible to measure recesses, grooves, etc.

In conjunction with the additional accessories; threads, bores, serrations, etc. can be measured.

Features

Functions:

- ON/OFF
- RESET (Set display to zero) mm/inch
- Reference-Lock/Unlock
- PRESET (for entering a numerical value)
- DATA (Data transmission via connection cable)
- Auto-ON/OFF
- Immediate measurement due to the Reference system
- Excellent resistance against dust, coolants and lubricants,

protection class IP67

- MarConnect data output, choose alternatively: USB, OPTO RS232C or Digimatic
- Dirt wipers are integrated in the slide
- Life of the battery up to 3 years
- Max measuring speed 2.5 m/s (100"/s)
- High contrast LCD with 8.5 mm

high digits

- Lapped guide way
- Slide and beam made of hardened stainless steel
- Measuring blades for inside measurement
- Step measuring function
- Locking screw
- Supplied with: Case, battery, operating instructions

Technical Data

Measuring range*	Resolution	Error limit G	Order no.	List price	Promo price
mm (inch)	mm / inch	mm			
200 (8")	0.01 / .0005"	0.03	4118807P**	\$567.00	\$482.00
200 (8")	0.01 / .0005"	0.03	4118808P***	\$335.00	\$285.00

* in conjunction with accessories the measuring range may change ** includes standard accessories *** excludes standard accessories

Accessories

	Order no.
Battery 3V, Type CR 2032	4102520P
Data Connection Cable USB (2 m)	16 EXu 4102357P
Data Connection Cable Opto RS232C (2 m), with SUB-D jack 9-pin	16 EXr 4102410P
Data Connection Cable Digimatic (2 m), Flat plug 10-pin	16 EXd 4102411P

Accessories for Data Processing see Chapter 11

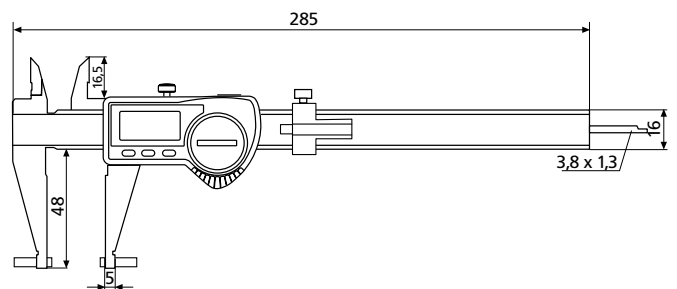

Digital Micrometer Micromar 40 EWR



REFERENCE

List Price From
\$250.00
Promo Price From
\$237.00



Features

Functions:

- RESET (Zero setting the display for Relative measurement)
- ABS (Switch between Relative and Absolute measurement) mm/inch
- Reference-Lock/Unlock
- PRESET (Reference setting)
- DATA (Data transmission via connection cable)
- Immediate measurement due to the Reference system
- MarConnect data output, choose alternatively USB
OPTO RS232C
Digimatic
- High contrast Liquid Crystal Display with 8.5 mm high digits
- Hard lacquered steel frame, heat insulated
- Spindle and anvil are carbide tipped
- Spindle is made of stainless steel, hardened throughout and ground
- Ratchet is integrated in the thimble
- Rapid drive
- Supplied with: Case, battery, operating instructions and setting standard (starting with measuring range 25-50 mm)

Technical Data

	Measuring range		Resolution mm / inch	Error limit G * µm	Spindle thread pitch mm	Data output 	Order no.	List price	Promo price
	mm	(inch)							
40 EWR	0 - 25	(0 - 1")	0.001 / 0.00005"	2	0.635	—	4151721P	\$250.00	\$237.00
40 EWR	0 - 25	(0 - 1")	0.001 / 0.00005"	2	0.635	●	4151705P	\$275.00	\$252.00
40 EWR	25 - 50	(1 - 2")	0.001 / 0.00005"	2	0.635	●	4151706P	\$285.00	\$258.00
40 EWR	50 - 75	(2 - 3")	0.001 / 0.00005"	3	0.635	●	4151707P	\$575.00	\$458.00
40 EWR	75 - 100	(3 - 4")	0.001 / 0.00005"	3	0.635	●	4151708P	\$603.00	\$464.00

* at fixed zero point (better than DIN 863-1)

Digital Micrometer Micromar 40 ER



REFERENCE



List Price
\$227.00
Promo Price
\$180.00

Features

Functions:

- RESET (Zero setting the display for Relative measurement)
- ABS (Switch between Relative and Absolute measurement)
- mm/inch
- Reference-Lock/Unlock
- PRESET (Reference setting)
- Immediate measurement due to the Reference system
- High contrast Liquid Crystal Display with 8.5 mm high digits
- Hard lacquered steel frame, heat insulated
- Spindle and anvil are carbide tipped
- Spindle is made of stainless steel, hardened throughout and ground
- Ratchet is integrated in the thimble
- Rapid drive
- Supplied with:
Case, battery and operating instructions

Technical Data

	Measuring range		Resolution	Error limit G *	Spindle thread pitch	Order no.	List price	Promo Price
	mm	(inch)	mm / inch	µm	mm			
40 ER	0 - 25	(0-1")	0.001 / 0.00005"	2	0.635	4151601P	\$227.00	\$185.00

* at fixed zero point (better than DIN 863-1)

Portable Thickness Gages MaraMeter 22P

- 22P-20 has the indicator built into the frame for maximum ruggedness
- Lift lever for one hand operation
- Continuous reading dials with revolution counter for absolute measurement of thin materials, plastic films and small parts
- Thickness gage XLI-22P-20 is supplied with the µMaxum II digital electronic indicator and can be Left/Right hand operated or front mounted
- XLI-22P-20 digital indicator can be rotated for right or left hand use

List Price From
\$539.00
Promo Price From
\$404.00



Technical Data

	Measuring range		Throat depth	Dial diameter	Dial grad	Resolution		Order no.	List price	Promo price
	Max	Min				(in) (selectable)	(mm) (selectable)			
Dial thickness gage	1.00"	0.0"	2.00	2.250"	0.001"	-	-	22P-20P	\$539.00	\$404.00
Digital thickness gage	1.00"	0.0"	2.00	2.250"	-	0.00001, 0.00002, 0.00005, 0.0001, 0.0002, 0.0005, 0.001	0.0002, 0.0005, 0.001, 0.002, 0.005, 0.01, 0.02	XLI-22P-20P	\$817.00	\$613.00

Self-Centering Measuring Pistol Micromar 844 A



List Price From
\$1,495.00
Promo Price From
\$1,271.00

**Self Centering Bore Gage Set
includes 1086 R digital indicator**

Applications

- For measuring:
- Through holes
 - Blind holes
 - Centering shoulders

Mahr Federal's 844A Self Centering Pistol style bore gages offer long measuring range with fixed anvils. The pistol grip incorporates a constant measuring pressure for locking onto the bore diameter with no operator influence.

Features include:

- Kits below are supplied with Digital Indicator 1086 R having 0.001mm/50u" resolution
- Large easy to read display
- Self centering measuring heads consists of three laterally positioned anvils, each are offset at 120° intervals
- Measuring heads larger than 12.5mm/0.5" are carbide tipped
- Measuring heads from 40mm/1.6" are made from aluminum to reduce weight
- Marcom output
- Optional Digital indicators are interchangeable for economical upgrade and maintenance

Optional accessories - contact Mahr Federal Inc for details

- Individual measuring heads
- Basic measuring pistol
- Delth extension rods
- adaptors for competitive pistols and measuring heads

Technical Data

	Measuring range		Measuring depth mm	Error limit G* µm / inch	Order no.***	List price	Promo price
	mm	(inch)					
6	- 8	(.25 - .3125")	64 / (139**)	3 / .00015	4487700P	\$1,495.00	\$1,271.00
8	- 10	(.3125 - .4")	64 / (139**)	3 / .00015	4487701P	\$1,495.00	\$1,271.00
10	- 12	(.4 - .472")	64 / (139**)	3 / .00015	4487702P	\$1,566.00	\$1,331.00
12	- 16	(.472 - .625")	65 / (140**)	3 / .00015	4487703P	\$1,512.00	\$1,285.00
16	- 20	(.625 - .775")	65 / (140**)	3 / .00015	4487704P	\$1,566.00	\$1,331.00
20	- 25	(.775 - 1")	70 / (220**)	3 / .00015	4487705P	\$1,586.00	\$1,348.00
25	- 30	(1" - 1.2")	70 / (220**)	3 / .00015	4487706P	\$1,606.00	\$1,365.00
30	- 40	(1.2 - 1.575")	71 / (221**)	3 / .00015	4487707P	\$1,616.00	\$1,374.00
40	- 50	(1.575" - 2")	79 / (229**)	3 / .00015	4487709P	\$1,606.00	\$1,365.00
50	- 60	(2" - 2.35")	79 / (229**)	4 / .00016	4487710P	\$1,856.00	\$1,578.00
60	- 70	(2.35 - 2.75")	79 / (229**)	4 / .00016	4487711P	\$1,776.00	\$1,510.00
70	- 85	(2.75 - 3.35")	97 / (247**)	4 / .00016	4487612P	\$1,796.00	\$1,527.00
85	- 100	(3.35 - 4")	97 / (247**)	4 / .00016	4487613P	\$1,826.00	\$1,552.00
100	- 125	(4 - 4.9")	132 / (282**)	5 / .0002	4487614P	\$2,026.00	\$1,722.00
125	- 150	(4.9 - 5.9")	132 / (282**)	5 / .0002	4487615P	\$2,216.00	\$1,884.00
150	- 175	(5.9 - 6.9")	132 / (282**)	6 / .00025	4487616P	\$2,296.00	\$1,952.00
175	- 200	(6.9 - 7.9")	132 / (282**)	6 / .00025	4487617P	\$2,386.00	\$2,028.00

MarCator 1086 R

The new Digital Indicator MarCator 1086 R. With the large display and the integrated tolerance function, your measurement results are clearly visual.

Clear display

Tolerance indication with the displayed value
Display is the actual measured value and the

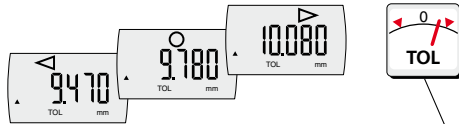

tolerance zone position

Tolerance indication without the value in the display. In and Out of tolerance will be indicated in the display as a symbol.

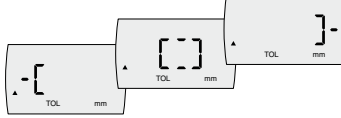

IP Protection class IP54 (optional)

- Protection cap is sealed
- Rubber bellows for the measuring spindle
- Sealed battery compartment

Error free operation



Lock function: This prevents unintentional activation of an operating button. Either all the operating buttons or only certain individual buttons can be locked. If a locked operating button is pressed the "LOC" symbol will appear in the display.

Universal Data-Interface



- **USB**
No interface box is required! Simple and inexpensive way to set up a multiple measuring instruments via a USB hub



- **Digimatic**
To connect a Digimatic compatible evaluation instrument



- **Mahr Opto RS232C**
For direct connection to a COM port on a PC



ABS

Absolute function:

Digital Indicator can be set in any position to 0.000 without losing the reference to the preset value.

REFERENCE



Self Centering bore gage kits

Mahr Federal's 844 A Self Centering Pistol style bore gage in kit form provides a versatile set for measuring many of your high precision bore gage applications.

Self-centering measuring head consists of 3 laterally positioned anvils, each are offset at intervals of 120°.

- Anvils from 12.5 mm are carbide tipped
- From 12.5 mm, anvils can be used to measure to the base of a bore
- From 40 mm all measuring heads are made from aluminum to reduce weight

Technical Data

Measuring range		Number of Measuring Heads	Ring Gages	Order no. with digital indicator 1086 R	List price	Promo Price
mm	(inch)					
6 - 12.5	(25 - 5")	3	8 / 10	4487760P	\$2,910.00	\$2,474.00
12.5 - 25	(5 - 1")	3	16 / 20	4487761P	\$2,910.00	\$2,474.00
25 - 50	(1 - 2")	4	30 / 40	4487762P	\$3,590.00	\$3,052.00
50 - 100	(2-4")	4	60 / 85	4487763P	\$3,860.00	\$3,281.00

- Supplied with:
1 Basic Instrument 844 Ag, Measuring Heads 44 Ak, case and ring gages

* Indicator is not taken into consideration, over the full length of the anvils

** With the extension 44 Av

*** Excludes indicator

Self-Centering Dial Bore Gages 844 N / 844 NH Intramess

List Price From
\$1,575.00

Promo Price From
\$1,339.00

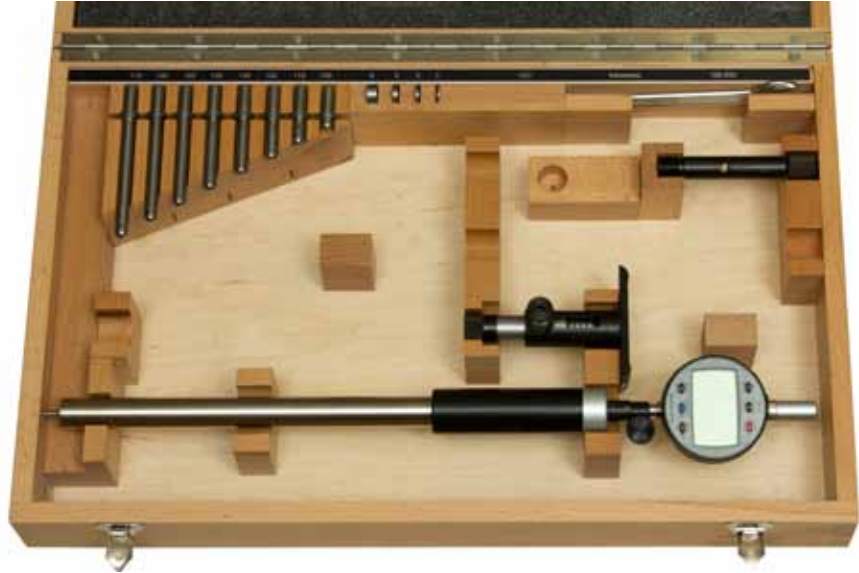

Features

The Mahr Federal adjustable bore gage kits have been built on the idea of precision measurement under tough shop conditions. Robust and easy to use, they provide a fast and accurate method for checking bores in most environments and applications. When supplied with the **1087 BR** digital indicator they proved high resolution, fast response and simple use for the operator with its dynamic capabilities. Other features include:

- Measuring the diameter, roundness and conical form of a bore as well as the distances of plane-parallel surfaces
- Measuring head consists of a carbide-tipped moving anvil and an interchangeable stationary anvil which has a hardened steel ball; alternatively a carbide ball is available
- Transmission lever system transfers movement of the movable anvil to indicating instrument
- The broad centering bridge ensures automatic centering in the bore
- Insensitive to temperature due to both the shank and transfer rod being made from heat resistant Invar steel
- Highly resistant to wear and tear due to the carbide tipped moving anvil
- Constant measuring force due to built-in spring thus eliminating user influence
- Universally applicable and extremely versatile as every instrument spans a broad measuring range, within this range it is quick and easy to adjust to any size
- Measuring head, holder, extensions, right-angle attachments and depth stops are all part of this extensive modular system
- Supplied with:
Holder, measuring head, stationary anvil, wooden case, excludes an indicating instrument

The comparison between Invar and Standard steel

Invar steel has a particularly low expansion coefficient and thus makes the instrument totally insensitive to any kind of heat. Body heat from the user, increases in ambient temperature have no influence on the measuring results.

The graph on the right compares the Invar steel version to a standard type. Both gages were hand-held and thus influenced by body heat. The deviation when using Invar steel is negligible.

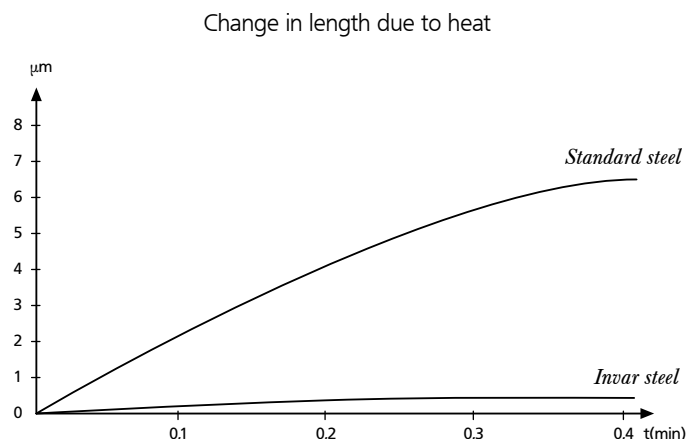

Marcator 1087 BR



Features

Functions:

- ON/OFF
- RESET (Set the display to zero)
- mm/inch
- Reversal of the counting direction
- PRESET (Allows the entry of any value using set buttons)
- TOL (Enter tolerance limit values)
- Tolerance band max. 1.6 mm
- START/STOP for searching the reversal point
- MAX/MIN memory, ideal for searching the reversal point
- ABS (Display can be set to zero, without losing the reference to the Preset value)
- 0 (Set analog display to zero)
- DATA (when connected with a data connection cable)
- Factor (adjustable)
- Immediate measurement due to the Reference system
- Individual buttons can be locked - Lock Function
- Operating and display unit (bezel) can be rotated 280°
- High contrast LCD with 8.5 mm high digits
- Inductive measuring system, battery life ca. 2000 hrs.
- Maximum measuring speed 1.5 m/s (60"/s)
- Sealed protection cap
- MarConnect data output: choose USB, OPTO RS232C, Digimatic
- Operating temperature 10 - 40°C
- Class of protection IP42 in accordance to IEC 60529
- Supplied with:
 - Battery, operating instructions

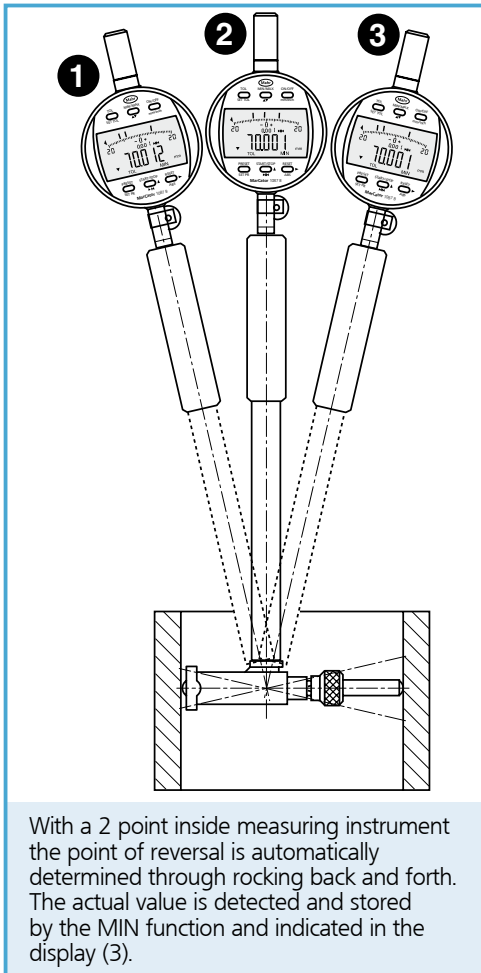

Analog display

Readings			Display range		
mm	/	inch	mm	/	inch
0.001	/	.00005"	± 0.02	/	± .001"
0.002	/	.0001"	± 0.04	/	± .002"
0.004	/	.0005"	± 0.08	/	± .01"
0.01	/	.001"	± 0.2	/	± .02"

Technical Data

Measuring range		Error limit	Repeatability	Hysteresis	Order no*	List price	Promo Price	Order no*	List price	Promo Price
mm	(inch)	G_e μm	f_w μm	f_u μm	844 N			844 NH Carbide		
18 - 50	50 (.7 - 2")	2	0.5	2.5	4474000P	\$1,414.00	\$1,202.00	4475000P	\$1,575.00	\$1,339.00
35 - 100	100 (1.4 - 4")	2	0.5	2.5	4474001P	\$1,514.00	\$1,287.00	4475001P	\$1,678.00	\$1,426.00
100 - 250	250 (4 - 10")	2	0.5	2.5	4474002P	\$1,981.00	\$1,684.00	4475002P	\$2,261.00	\$1,922.00
250 - 400	400 (10 - 16")	3	1.5	3.5	4474003P	\$5,011.00	\$4,259.00	4475003P	\$5,721.00	\$4,863.00
400 - 800	800 (16 - 32")	3	1.5	3.5	4474004P	\$5,221.00	\$4,438.00	4475004P	\$6,641.00	\$5,645.00
250 - 800	800 (10 - 32")	3	1.5	3.5	4474005P	\$5,751.00	\$4,888.00	4475005P	\$6,971.00	\$5,925.00

* Excludes indicating instrument

Adjustable Bore Gages 1280 P

Adjustable Bore Gages 1280 P

Superior Accuracy for Production and Inspection.



1282P-3W2 and 1280P-1W1

Features

- Rugged construction for long life and low maintenance: Stainless steel gaging head, one piece centralizing yoke with replaceable tungsten carbide balls.
- Heavy duty housing protects Indicator.
- Flow-through design makes Series 1280P Bore Gages swish clean, no disassembly required.
- Outstanding stability: Holds mastered value.
- Furnished with either Dial Indicator or *Maxum[®] III* Digital Electronic Indicator.
- Digital bore gages with output are provided with *Maxum[®] III* Indicators. The Dynamic memory of the *Maxum[®] III* greatly simplifies operation and assures repeatable readings with a single sweep of the diameter being measured.
- Output available for Statistical Quality Control requirements.

List Price From
\$1,406.00
Promo Price From
\$1,220.00

Technical Data

With Dial Indicator

Range of Sensitive Contact: 0.63 mm / **.025"**,
0.002 mm / **.0001"** grad.

With *Maxum[®] III* Indicators

Range of Sensitive Contact: 0.39 mm / **.020"**,
Resolution: 0.001 mm / **.00005"** resolution,
0.001 mm / **.001"** grad.

If gage capacity is 25 mm / 1" or greater, the *Maxum[®] III* Indicator is covered with a cast aluminum protective housing. If under 25 mm / 1" capacity, the protective housing is not normally furnished.

Capacity mm / inch	Gaging depth mm / inch	End of head contact mm / inch	With dial indicator Order no.	List price	Promo price
12 - 25mm / 0.5 - 1"	76mm / 3"	2.77 / .11"	1280P-1S1P	\$1,406.00	\$1,220.00
25 - 50mm / 1 - 2"	152mm / 6"	4.37 / .17"	1280P-2S2P	\$1,396.00	\$1,210.00
50 - 203mm / 2 - 8"	152mm / 6"	7.92 / .31"	1280P-3S2P	\$1,610.00	\$1,400.00
12 - 25mm / 0.5 - 1"	152mm / 6"	2.77 / .11"	1280P-1S2P	\$1,406.00	\$1,220.00
25 - 50mm / 1 - 2"	305mm / 12"	4.37 / .17"	1280P-2S3P	\$1,396.00	\$1,210.00
50 - 203 / 2 - 8"	305mm / 12"	7.92 / .31"	1280P-3S3P	\$1,610.00	\$1,400.00
Capacity	Gaging depth	End of head contact mm / inch	With <i>Maxum[®] III</i> indicator Order no.	List price	Promo price
12 - 25mm / 0.5 - 1"	76mm / 3"	2.77 / .11"	1282P-1S1P	\$1,754.00	\$1,540.00
25 - 50mm / 1 - 2"	152mm / 6"	4.37 / .17"	1282P-2S2P	\$1,744.00	\$1,530.00
50 - 203mm / 2 - 8"	152mm / 6"	7.92 / .31"	1282P-3S2P	\$1,968.00	\$1,680.00
12 - 25mm / 0.5 - 1"	152mm / 6"	2.77 / .11"	1282P-1S2P	\$1,754.00	\$1,540.00
25 - 50mm / 1 - 2"	305mm / 12"	4.37 / .17"	1282P-2S3P	\$1,744.00	\$1,530.00
50 - 203 / 2 - 8"	305mm / 12"	7.92 / .31"	1282P-3S3P	\$1,968.00	\$1,680.00

Series 1280P Adjustable Bore Gages are normally furnished with adjusting wrenches and steel contacts.

Handles / Housing

All 1280P Gages have a removable handle as a part of the Indicator Housing.

All 1282P Gages can be equipped with a handle which projects at 90° to the gage housing.

1282P Gages with capacity 12-25 mm / .50-1" are not normally furnished with a protective housing. Handles and Housings may be ordered separately.

For Handles order **HA-88** with **AT-124** Adaptor. For Housings order **EHG-1198**.

Gaging Extensions

Specify the Reference Contact Gaging Extensions required. For all diameters below 50 mm / 2" the Reference Contact is integral with each Extension. For diameters over 50 mm / 2" the Reference Contact is separate and interchangeable among Extension Sets.

*Talk to the Mahr Federal Tech Group for further information at:
800-343-2050*



Other bore gage solutions from Mahr Federal

Dial bore gage 844 N



- Measuring the diameter, roundness and conicity of bores
- Spring-loaded halves of measuring probe are split via expanding pin with precision lapped taper. This movement is transferred to indicating instrument
- Maximum wear-resistance due to hard chrome plating. From 4 mm alternatively with carbide tipped available on request
- Constant measuring force as a result of built-in spring thus eliminating user influence
- Highly versatile, each gage covers a large range. Within the respective limits, quickly and easily adjustable to any size and any type of measuring application
- Measuring probe, holder, depth extensions, right-angle attachments and depth stops are part of an extensive modular system

Dimentron® plug gage



Fixed Plug Gaging is the inspection tool that allows you to measure many jobs faster, more conveniently, and more accurately than by other gaging methods. In the measurement of all hole conditions, the Dimentron System is unsurpassed for speed and accuracy. In standard applications it offers sufficient magnification and reliability to measure tolerances well beyond the scope of mechanical gages. For critical dimension applications special designs can be implemented to enhance the performance for some of the most demanding requirements.

Air gages for bores



Air gages measure dimension deviations quickly and precisely. For years, they have proven themselves as high quality length measuring units in industrial production and inspection rooms. Air measuring tooling such as plug and ring gages determine the part dimension without contact. The measuring values of the air tooling is quickly displayed by a range of Millimar display units for bench or portable application.

μ Dimensionair®. Air gages

Features

- Affordable • Versatile • Innovative • Rugged

No other air gaging system offers so much — in the palm of your hand — mounted to the workbench or even right to the machine tool. μ Dimensionair is rated IP-54, so, it can be used on the shop floor — and, the air tooling cleans dirt from the part for high performance measurements — fast and easy!

- Air gage readout is right in front of you — simple and clear
- Fixed resolution and balanced air system makes the gage stable and reliable for your manufacturing environment

Contact Mahr Federal Technical Support
for selecting air tooling



The μ Dimensionair II is the ultimate of portability and versatility — in your hand or at the workbench or machine tool. Shown with optional **2239307** Bench Kit



Versatility

The ultimate in configuration — interchangeable handle allows for pistol grip or normal end-mount for easy application of the plug to the part. For large, heavy plugs, mount the handle between the tooling and the display — assures a well-balanced, ergonomic measuring system. Can also be mounted to a bench stand when parts are brought to the gage.

Technical Data

Measuring Range mm/inch	Digital Resolution mm/inch	Tooling I.D. Number
$\pm 0.080 / \pm 0.003''$	0.001/ 0.00005''	60
$\pm 0.040 / \pm 0.0016''$	0.0005/ 0.00002''	50
$\pm 0.020 / \pm 0.00076''$	0.0005/ 0.00002''	20
Operating Temperature	5 - 35° C / 41 - 95° F	
Storage Temperature	0 - 60° C / 32 - 140° F	
Repeatability	± 1 digit	
Calibration Accuracy	± 1 digit	
Response Time	Approximately 1 second	
Thermal Stability	0.1% of full scale/F	
Data Output	ASCII/Digimatic	
Weight	25 kg / 5lbs.	
Auto Power Off	15 minutes of non-use	
Power Requirements	3 volt lithium battery coin cell, 2 per unit — CR-2450	
Air Supply	2.10 \pm .01 bar / 30.4 \pm .15 psi	
Display	Rotates through 270 degrees	

Ordering

	Order no.	Price
μ Dimensionair complete with handle, adaptor and hose	2103200+CAL	\$1,190.00
Pressure Regulator with filter (required)	2238020P	\$278.00
Bench Kit with adaptor	2239307P	\$175.00

36B - I.D./O.D. Gages



- For measuring shafts, bolts, spindles, and other cylindrical parts for thickness and length
- Constant measuring force reduces error
 - Easily adjustable measuring range
 - Direct indication of measuring results
 - Forged steel frame, carbide tipped measuring faces optionally available



List Price From
\$2,630.00
Promo Price From
\$2,367.00



An I.D./O.D. gaging system with increased versatility

The 36B I.D./O.D. gage is offered with both the "T" plate and "V" plate in the same package. Along with the system will be a 1087B Digital Indicator with latching ability (Min/Max) to save time with both the setup and the measuring process.

When using the 1087B on the 36B gage you simply zero and look for your high and low on the master using the analog scale and re-zero. Place the workpiece on the gage and press the blue start button and

the indicator latches on the high or low depending if you're measuring I.D.'s or O.D.'s, and you're good to go.

- All in one inclusive package
- Faster setup time with the 1087B
- Inch / Metric
- Capability for wireless transmission
- Quicker mastering with Analog / Digital display

Ordering Information

Description	Capacity		Order no.	List Price	Promo Price
	ID	OD			
EDI-36B-10 with "T" Plate and μ Max μ m II	0.75-3.50" (19-89mm)	0.25-5.0" (6-127mm)	EDI-36B-10+CAL	\$2,630.00	\$2,367.00
EDI-36B-9 with "V" Plate and μ Max μ m II	0.812-4.625" (21-117mm)	0.312-5.0" (8-127mm)	EDI-36B-9+CAL	\$2,630.00	\$2,367.00
36B-10 with Both "T" and "V" Plates and 1087B	Refer to "V" and "T" plate ID/OD dimensions above		2061657+CAL	\$3,210.00	\$2,889.00

▶ | **DIMENSIONAL METROLOGY**



Precision Gages

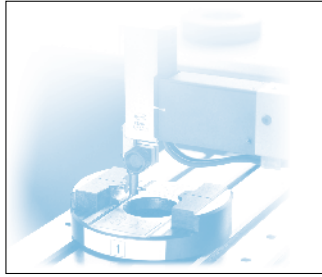

Precimar.
Precision Length Metrology

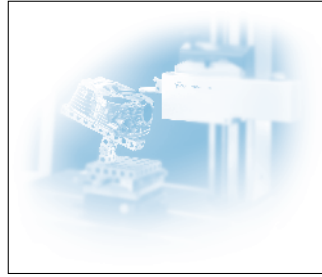

MarSurf.
Surface Metrology



MarForm.
Form Metrology

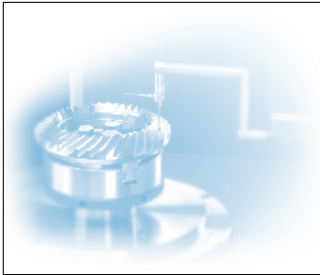

MarGear.
Gear Metrology

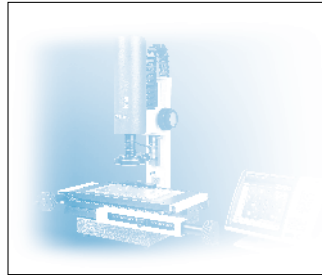

MarVision.
Optical Metrology

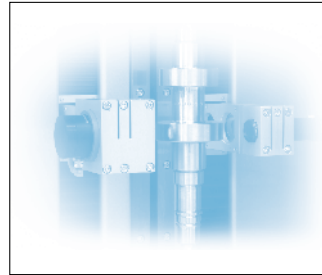

MarShaft.
Shaft Metrology



Services

WWW.MAHR.COM

|
- 0 +



E X A C T L Y