



Mitutoyo Corporation  
80th Anniversary  
Since 1934



MDC Micrometers  
See Page 2



MeasurLink  
See Page 24



QM-Height Gages  
See Page 19

# Fall Promo 2014



## Precision Tools & Instruments

Prices effective September 8 – December 12, 2014



## Dear Valued Customers,

With our 50th Anniversary celebration behind us at Mitutoyo America Corporation, we are now assisting our parent company, Mitutoyo Corporation, in the celebration of their 80th Anniversary. Throughout the year there will be special promotions, events, and other activities occurring to publicize the anniversary.

It is important for us to take this opportunity to personally thank the companies and individuals who partner with us, for their continued support and commitment as we help Mitutoyo Corporation celebrate 80 years of excellence.

The Fall Promotion is our second large scale Precision Tool Promotion of 2014 and will be effective from September 8, through December 12, 2014.

Please check our website at [www.mitutoyo.com](http://www.mitutoyo.com) to watch for other exciting events developing at Mitutoyo during our year of celebration.

Sincerely,

Shigeyuki Sasaki  
President, Mitutoyo America Corporation



**Mitutoyo Corporation**  
80th Anniversary  
Since 1934

## MDC Micrometers



293-330-30



293-335-30



MDC Lite  
293-832-30

### Features

- New electromagnetic ABSOLUTE sensor - Improved resistance to environmental conditions such as dirt, oil and water that can cause false readings
- New ratchet thimble models improve one-hand operability
- New Anti-slip finish for improved grip while taking measurements
- Long battery life – 2.4 years under normal operation
- Fully compatible with existing Mitutoyo Digimatic peripherals (SPC Cables, U-Wave wireless transmitters, DP1-VR...etc) – SPC output enabled IP65 Models
- Function-lock system prevents inadvertent setting changes



### Ratchet Thimble

Ratchet thimble

Speeder

### Improved operability with one hand



Order No.	Range	Resolution	Remarks	List Price	Sale Price
<b>IP65 - With SPC Output</b>					
293-330-30	0-1" / 0-25.4mm	.00005" / 0.001mm	Ratchet Stop,	\$240.00	<b>\$228.00</b>
293-335-30	0-1" / 0-25.4mm	.00005" / 0.001mm	Friction Thimble	\$240.00	<b>\$228.00</b>
293-331-30	1-2" / 25.4-50.8mm	.00005" / 0.001mm	Ratchet Stop w/Standard	\$283.00	<b>\$268.85</b>
<b>IP65 - Non-SPC Output</b>					
293-340-30	0-1" / 0-25.4mm	.00005" / 0.001mm	Ratchet Stop	\$178.00	<b>\$169.10</b>
293-344-30	0-1" / 0-25.4mm	.00005" / 0.001mm	Ratchet Thimble	\$178.00	<b>\$169.10</b>
293-348-30	0-1" / 0-25.4mm	.00005" / 0.001mm	Friction Thimble	\$178.00	<b>\$169.10</b>
293-349-30	0-1" / 0-25.4mm	.0001" / 0.001mm	Ratchet Thimble	\$178.00	<b>\$169.10</b>
293-341-30	1-2" / 25.4-50.8mm	.00005" / 0.001mm	Ratchet Stop w/Standard	\$243.00	<b>\$230.85</b>
293-345-30	1-2" / 25.4-50.8mm	.00005" / 0.001mm	Ratchet Thimble w/Standard	\$243.00	<b>\$230.85</b>
<b>MDC Lite Micrometers</b>					
293-831-30	0 - 1" / 0 - 25.4mm	.00005" / 0.001mm	Ratchet Stop	\$135.00	<b>\$128.25</b>
293-832-30	0 - 1" / 0 - 25.4mm	.00005" / 0.001mm	Friction Thimble	\$139.00	<b>\$132.05</b>

Order No.	Description	List Price	Sale Price
05CZA662	40" IP65 Mic Cable	\$83.80	<b>\$79.60</b>
05CZA663	80" IP65 Mic Cable	\$92.45	<b>\$87.85</b>





## QuantuMike

Coolant Proof Micrometer



**IP65**

### Features

- Faster measurement with 2mm travel per revolution instead of the standard 0.5mm
- A patented ratchet thimble mechanism helps ensure repeatability
- A Function lock helps prevent error
- IP-65 protection level
- Certificate of inspection is provided

### Significant reduction in positioning time

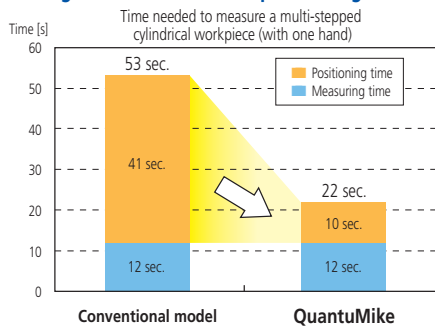

Order No.	Range	Resolution	List Price	Sale Price
293-180*	0-1"/0-25mm	.00005"/0.001mm	\$262.00	<b>\$248.90</b>
293-181*	1-2"/25-50mm	.00005"/0.001mm	\$300.00	<b>\$285.00</b>
293-185	0-1"/0-25mm	.00005"/0.001mm	\$226.00	<b>\$214.70</b>
293-186	1-2"/25-50mm	.00005"/0.001mm	\$258.00	<b>\$245.10</b>

\*with SPC Output

Order No.	Description	List Price	Sale Price
05CZA662	40" IP65 Mic Cable	\$83.80	<b>\$79.60</b>
05CZA663	80" IP65 Mic Cable	\$92.45	<b>\$87.85</b>

## MDH Micrometer

High-Accuracy Sub-Micron Digimatic Micrometer



### Features

- Enabling .000005"/0.1µm resolution measurement, this micrometer is ideal for customers who need to make highly accurate measurements with a hand-held tool.
- The ABS (absolute) rotary sensor also eliminates the need to perform origin setting each time the power is turned on, letting you start measuring straight away. With no possibility of overspeed errors, the High-Accuracy Digimatic Micrometer also delivers a higher level of reliability.

Order No.	Range	Resolution	Accuracy	List Price	Sale Price
293-100	0 - 25mm	0.0001mm/ 0.0005mm (switchable)	±0.5µm	\$1,630.00	<b>\$1,467.00</b>
293-130	0 - 1" 0 - 25.4mm	.000005"/.00002" 0.0001mm/0.0005mm (switchable)	±.00002"	\$1,630.00	<b>\$1,467.00</b>

Order No.	Description	List Price	Sale Price
05CZA662	Cable(1m)	\$83.80	<b>\$79.60</b>
05CZA663	Cable (2m)	\$92.45	<b>\$87.85</b>

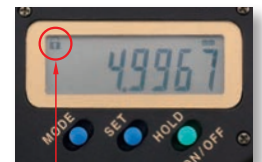

Function lock

## Micrometer Stand

The micrometer stand is designed to provide the convenience of a benchtop tool with hand micrometers or other gages.



For micrometers ranging in size .5" - 4"  
Micrometer sold separately

Order No.	Description	List Price	Sale Price
156-101-10	Micrometer Stand	\$110.00	<b>\$99.00</b>



**Mitutoyo Corporation**  
80th Anniversary  
Since 1934

## Digimatic Uni-Mike



317-351



### Features

- Measures tube thickness, shoulder-edge distance, rivet head height, etc. with interchangeable anvils (flat anvil, rod anvil, V-anvil).
- Supplied with flat anvil and rod anvil.

Order No.	Range	LCD Resolution	Accuracy	Remarks	List Price	Sale Price
317-351	0-1" / 0-25mm	.00005"/0.001mm	±.0002"	Interchangeable Anvils IP-65 with SPC output	\$529.00	<b>\$476.10</b>
317-352	1-2" / 25-50mm	.00005"/0.001mm	±.0002"		\$538.00	<b>\$484.20</b>

Order No.	Description	List Price	Sale Price
05CZA662	40" IP65 Mic Cable	\$83.80	<b>\$79.60</b>
05CZA663	80" IP65 Mic Cable	\$92.45	<b>\$87.85</b>



## Uni-Mike



117-107

### Features

- Measures tube thickness, shoulder-edge distance, rivet head height, etc. with interchangeable anvils (flat anvil, rod anvil, V-anvil).
- Supplied with flat anvil and rod anvil.

Order No.	Range	Graduations	Remarks	List Price	Sale Price
117-107	0-1"	.0001"		\$208.00	<b>\$187.20</b>
117-108	1-2"	.0001"	w/1" standard	\$244.00	<b>\$219.60</b>

## Digit Outside Micrometers



193-211

### Features

- Mechanical digit counter with .001" reading for quick and error-free reading.
- Supplied in fitted plastic case.

Order No.	Range	Graduations	Remarks	List Price	Sale Price
193-211	0-1"	.0001"	Friction Thimble	\$186.00	<b>\$176.70</b>
193-212	1-2"	.0001"	Friction Thimble w/standard	\$219.00	<b>\$208.05</b>
193-213	2-3"	.0001"	Ratchet Stop w/standard	\$245.00	<b>\$232.75</b>
193-214	3-4"	.0001"	Ratchet Stop w/standard	\$271.00	<b>\$257.45</b>

## Tool Kits



64PKA069

The very basic measuring instruments recommended for vocational students and machinist apprentices are supplied in this tool kit.

Order No.	Includes these Items	List Price	Sale Price
64PKA069	103-135 Outside Micrometer (Friction Thimble Type) (Range: 0-1", Graduation: .0001")	\$410.00	<b>\$389.50</b>
	182-202 6" Full-Flexible Rule (16R)		
	513-518T Test Indicator Set (Range: .04", Graduation: .001")		
	505-675 675 Dial Caliper (Range: 0-6", Dial Graduation: .001")		
	050501 Mahogany Case		



Mitutoyo Corporation  
80th Anniversary  
Since 1934

## Outside Micrometers — Inch Models



103-260



103-221

### Features

- Hammertone, baked-enamel-finished frame.
- With a standard bar except for 0-1" model.

Order No.	Range	Graduations	Remarks	List Price	Sale Price
103-260	0-1"	.0001"	Ratchet Stop	\$118.00	<b>\$106.20</b>
103-262	1-2"	.0001"	Ratchet Stop	\$138.00	<b>\$124.20</b>
103-132	1-2"	.0001"	Ratchet Stop	\$122.00	<b>\$109.80</b>
103-217	2-3"	.0001"	Ratchet Stop	\$154.00	<b>\$138.60</b>
103-218	3-4"	.0001"	Ratchet Stop	\$177.00	<b>\$159.30</b>
103-219	4-5"	.0001"	Ratchet Stop	\$192.00	<b>\$172.80</b>
103-220	5-6"	.0001"	Ratchet Stop	\$213.00	<b>\$191.70</b>
103-221	6-7"	.0001"	Ratchet Stop	\$241.00	<b>\$219.90</b>
103-222	7-8"	.0001"	Ratchet Stop	\$254.00	<b>\$228.60</b>
103-223	8-9"	.0001"	Ratchet Stop	\$282.00	<b>\$253.80</b>
103-224	9-10"	.0001"	Ratchet Stop	\$292.00	<b>\$262.80</b>
103-225	10-11"	.0001"	Ratchet Stop	\$306.00	<b>\$275.40</b>
103-226	11-12"	.0001"	Ratchet Stop	\$319.00	<b>\$287.10</b>
<b>Micrometer Sets</b>					
103-922	0-3"	3 pcs/set includes: 103-135, 103-136, 103-217, 2pcs. Micrometer Standards		\$431.00	<b>\$387.90</b>

## Outside Micrometers



101-119

### Features

- Improved repeatability for both "expert" and novice users
- Constant force device allows easy one-handed operation
- Full wrap heat insulation cover (102 Series)
- Certificate of Inspection provided
- Speeder for quick thimble rotation
- Carbide measuring faces

Order No.	Range	Graduations	Accuracy	List Price	Sale Price
<b>With Ratchet Stop</b>					
101-113	0-1"	.0001"	±.0001"	\$162.00	<b>\$145.80</b>
101-114*	1-2"	.0001"	±.0001"	\$162.00	<b>\$145.80</b>
101-119*	2-3"	.0001"	±.0001"	\$177.00	<b>\$159.30</b>
101-120*	3-4"	.0001"	±.00015"	\$195.00	<b>\$175.50</b>
<b>With Friction Thimble</b>					
101-117	0-1"	.0001"	±.0001"	\$133.00	<b>\$119.70</b>
101-118*	1-2"	.0001"	±.0001"	\$162.00	<b>\$145.80</b>

\* Standard Included

## Mitutoyo Micrometer Production

Mitutoyo micrometers begin at our automated casting facility in Gohara. This facility provides many cast products to various Mitutoyo manufacturing plants for further processing into world-class measuring tools and instruments.

Once the raw castings are completed they are transferred to one of our manufacturing facilities at Shiwa. Here they are machined converting them into a finished high quality rigid frame required to ensure high accuracy. The frames are then combined with the other components produced in Shiwa such as spindles, anvils, thimbles, etc. to complete the production.

The process does not stop here. Each instrument is quality inspected and tested to ensure full compliance to Mitutoyo and other world standards. Automatic inspection systems employed to provide a full inspection certificate for each tool, which is then packaged and prepared to be shipped to one of our many global Mitutoyo locations.





## Disk Micrometers



323-350

**IP65**

### Features

- .028" / 0.7mm (1mm: models over 100mm) edge thickness to enter narrow recesses.
- With Ratchet Stop for constant force.
- With SPC output
- Supplied in fitted plastic case. (Over 100mm models supplied wooden cases)

Order No.	Range	Resolution	Accuracy	List Price	Sale Price
<b>323-350</b>	0 - 1" / 0 - 25.4mm	.00005" / 0.001mm	±.0002"	\$499.00	<b>\$474.05</b>
<b>323-351</b>	1 - 2" / 25.4 - 50.8mm	.00005" / 0.001mm	±.0002"	\$560.00	<b>\$532.00</b>
<b>323-352</b>	2 - 3" / 50 - 76.2mm	.00005" / 0.001mm	±.0003"	\$632.00	<b>\$600.40</b>
<b>323-353</b>	3 - 4" / 76.2 - 101.6mm	.00005" / 0.001mm	±.0003"	\$669.00	<b>\$635.55</b>



Order No.	Description	List Price	Sale Price
<b>05CZA662</b>	40" IP65 Mic Cable	\$83.80	<b>\$79.60</b>
<b>05CZA663</b>	80" IP65 Mic Cable	\$92.45	<b>\$87.85</b>



## Spline Micrometers



331-351



331-361

**IP65**

### Features

- IP65 water/dust protection (Series 331).
- The anvil and spindle have a small diameter for measuring splined shafts, slots, and keyways.
- With Ratchet Stop for constant force.
- With SPC output (Series 331).
- With a standard bar except 0-1" and 0-25mm model.
- Supplied in fitted plastic case.

Order No.	Range	Resolution	Accuracy	Remarks	list Price	Sale Price
<b>331-351</b>	0 - 1" /	00005" /	±.0001"	Type A	\$470.00	<b>\$446.50</b>
<b>331-361</b>	0 - 25.4mm	0.001mm	±.0001"	Type B	\$470.00	<b>\$446.50</b>
<b>331-352</b>	1 - 2" /	00005" /	±.0001"	Type A	\$527.00	<b>\$500.65</b>
<b>331-362</b>	25.4-50.8mm	0.001mm	±.0001"	Type B	\$527.00	<b>\$500.65</b>
<b>331-353</b>	2 - 3" /	.00005" /	±.0001"	Type A	\$571.00	<b>\$542.45</b>
<b>331-363</b>	50.8-76.2mm	0.001mm	±.0001"	Type B	\$549.00	<b>\$521.55</b>
<b>331-354</b>	3 - 4" /	.00005" /	±.00015"	Type A	\$661.00	<b>\$627.95</b>
<b>331-364</b>	76.2-101.6mm	0.001mm	±.00015"	Type B	\$577.00	<b>\$548.15</b>

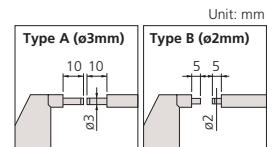

Order No.	Description	List Price	Sale Price
<b>05CZA662</b>	40" IP65 Mic Cable	\$83.80	<b>\$79.60</b>
<b>05CZA663</b>	80" IP65 Mic Cable	\$92.45	<b>\$87.85</b>



## Point Micrometers



342-351



### Features

- IP65 water/dust protection
- Pointed spindle and anvil for measuring the web thickness of drills, small grooves, keyways, and other hard-to-reach dimensions.
- 15 degree and 30 degree measuring points are available.
- The measuring points have approximately 0.3mm / .012" radius.
- With a standard bar except 0 - 1" and 0 - 25mm model.
- With SPC output
- Supplied in fitted plastic case.



Order No.	Range	Resolution	Accuracy	Point	List Price	Sale Price
342-351	0 - 1" / 0 - 25.4mm	00005" / 0.001mm	±.0001"	15°	\$462.00	<b>\$438.90</b>
342-361			±.0001"	30°	\$451.00	<b>\$428.45</b>
342-352	1 - 2" / 25.4-50.8mm	00005" / 0.001mm	±.0001"	15°	\$515.00	<b>\$489.25</b>
342-362			±.0001"	30°	\$504.00	<b>\$478.80</b>
342-353	2 - 3" / 50.8-76.2mm	.00005" / 0.001mm	±.0001"	15°	\$537.00	<b>\$510.15</b>
342-363			±.0001"	30°	\$527.00	<b>\$500.65</b>
342-354	3 - 4" / 76.2-101.6mm	.00005" / 0.001mm	±.00015"	15°	\$561.00	<b>\$532.95</b>
342-364			±.00015"	30°	\$571.00	<b>\$542.45</b>

Order No.	Description	List Price	Sale Price
05CZA662	40" IP65 Mic Cable	\$83.80	<b>\$79.60</b>
05CZA663	80" IP65 Mic Cable	\$92.45	<b>\$87.85</b>



## Blade Micrometers



422-330



### Features

- .028" / 0.7mm (1mm: models over 100mm) edge thickness to enter narrow recesses.
- With Ratchet Stop for constant force.
- With SPC output
- Supplied in fitted plastic case.



Order No.	Range	Resolution	Accuracy	Remarks	List Price	Sale Price
422-330	0 - 1" / 0 - 25.4mm	.00005" / 0.001mm	±.00015"	Type A	\$780.00	<b>\$702.00</b>
422-331	1 - 2" / 25.4 - 50.8mm	.00005" / 0.001mm	±.00015"	Type A	\$835.00	<b>\$751.50</b>
422-332	2 - 3" / 50 - 76.2mm	.00005" / 0.001mm	±.00015"	Type A	\$883.00	<b>\$794.70</b>
422-333	3 - 4" / 76.2 - 101.6mm	.00005" / 0.001mm	±.0002"	Type A	\$920.00	<b>\$828.00</b>

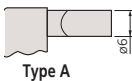
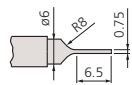

Type A

Order No.	Description	List Price	Sale Price
05CZA662	40" IP65 Mic Cable	\$83.80	<b>\$79.60</b>
05CZA663	80" IP65 Mic Cable	\$92.45	<b>\$87.85</b>



# Micrometer Heads

148-121



**148 Series Small Size Standard Style Micrometer Heads**

Standard small size make these mic heads convenient for many gage fixtures.

148-201



**148 Series Ultra-Small/Small Size Style Micrometer Heads**

Extra small size make these mic heads fit where larger mic heads won't.

150-802



**150 Series Mid Size Standard Style Micrometer Heads**

The longer range make these mic heads great for wide range adjustment applications.

Order No.	Graduation	Range	Stem Dia.	Stem	Spindle Face	Remarks	List Price	Sale Price
<b>Common Size Small Type Micrometer Heads</b>								
148-811	.001"	0 - .5"	.375"	Plain	Spherical (SR4)		\$66.05	<b>\$59.45</b>
148-502	.001"	0-.5"	.375"	w/clamp nut & Spindle Lock	Flat		\$68.40	<b>\$61.55</b>
148-801	0.01mm	0-13mm	9.5mm	Plain	Spherical (SR4)		\$66.05	<b>\$59.45</b>
148-121	0.01mm	0-13mm	9.5mm	Plain with Spindle Lock	Flat	-	\$70.25	<b>\$63.25</b>
<b>Ultra-Small/Small Size Micrometer Heads</b>								
148-202	.001"	0-.250"	.250"	Plain	Flat	-	\$62.85	<b>\$56.60</b>
148-206	.001"	0-.250"	.250"	Plain	Spherical (SR3)	-	\$64.70	<b>\$58.25</b>
148-208	.001"	0-.250"	.250"	with Clamp Nut	Spherical (SR3)	-	\$66.05	<b>\$59.45</b>
148-201	0.01mm	0-6.5mm	6mm	Plain	Flat	-	\$62.85	<b>\$56.60</b>
148-205	0.01mm	0-6.5mm	6mm	Plain	Spherical (SR3)	-	\$64.70	<b>\$58.25</b>
148-207	0.01mm	0-6.5mm	6mm	with Clamp Nut	Spherical (SR3)	-	\$66.05	<b>\$59.45</b>
<b>150 Series Mid Size Standard Style Micrometer Heads</b>								
150-208	.001"	0-1"	.375"	Plain	Flat (Carbide Tip)	-	\$75.20	<b>\$67.70</b>
150-812	.001"	0-1"	.375"	with Clamp Nut	Spherical (SR4)	-	\$80.70	<b>\$72.65</b>
150-802	0.01mm	0-25mm	10mm	with Clamp Nut	Spherical (SR4)	-	\$80.70	<b>\$72.65</b>

## Variety of Specifications

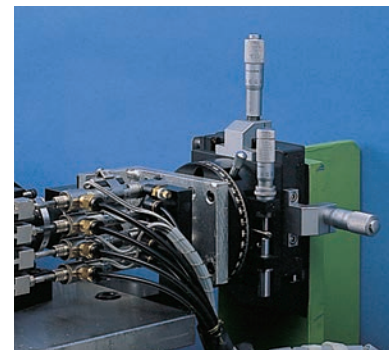
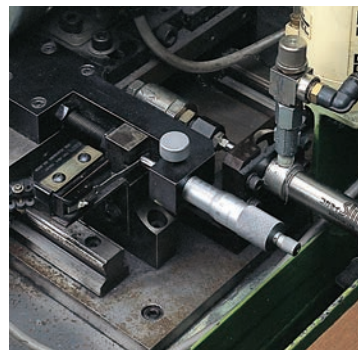
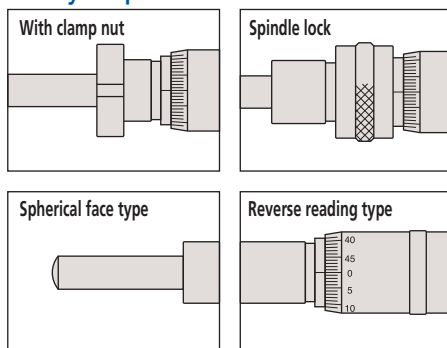



## ABSOLUTE Coolant Proof Calipers

Order No.	Range	List Price	Sale Price
<b>Non-Output Style</b>			
500-752-10	0-6"/0-150mm	\$209.00	<b>\$198.55</b>
500-753-10	0-8"/0-200mm	\$280.00	<b>\$266.00</b>
500-754-10	0-12"/0-300mm	\$484.00	<b>\$459.80</b>
<b>SPC Output Style</b>			
500-762-10	0-6"/0-150mm	\$248.00	<b>\$235.60</b>
500-763-10	0-8"/0-200mm	\$312.00	<b>\$296.40</b>

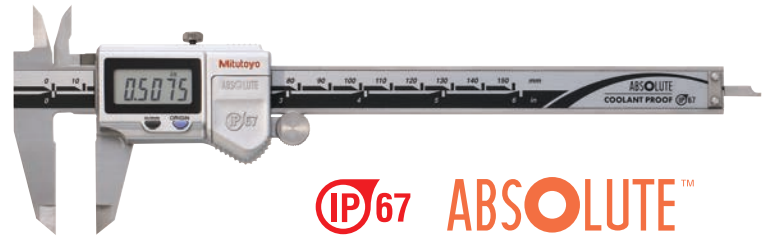

**IP67 ABSOLUTE™**

### Features

- It's sealed housing is IP-67 rated, meaning it's immune to the coolants, dirt, grit and chips found in many manufacturing environments.
- .0005"/0.01mm resolution with  $\pm 0.001$ " accuracy for 6" models and 8" models.
- Certificate of inspection provided (4"/6"/8" models).



Order No.	Description	List Price	Sale Price
05CZA624	40" IP Caliper Cable	\$93.90	<b>\$89.20</b>
05CZA625	80" IP Caliper Cable	\$95.35	<b>\$90.60</b>

## ABSOLUTE Digimatic Calipers

**ABSOLUTE™**



500-196-30

**ABSOLUTE AOS DIGIMATIC**

AOS: Advanced Onsite Sensor



Order No.	Range	Remarks	List Price	Sale Price
<b>No SPC Output Style</b>				
500-195-30	0-4"/0-100mm	.075" Round depth bar	\$144.00	<b>\$136.80</b>
500-196-30	0-6"/0-150mm		\$156.00	<b>\$148.20</b>
500-197-30	0-8"/0-200mm		\$224.00	<b>\$212.80</b>
500-193	0-12"/0-300mm		\$450.00	<b>\$427.50</b>
<b>With SPC Output Style</b>				
500-170-30	0-4"/0-100mm	.075" Round depth bar	\$172.00	<b>\$163.40</b>
500-171-30	0-6"/0-150mm		\$183.00	<b>\$173.85</b>
500-172-30	0-8"/0-200mm		\$241.00	<b>\$228.95</b>
500-173	0-12"/0-300mm		\$525.00	<b>\$498.75</b>
500-505-10	0-18"/0-450mm	Without Thumb Roller	\$819.00	<b>\$778.05</b>
500-506-10	0-24"/0-600mm	Without Thumb Roller	\$900.00	<b>\$855.00</b>
500-507-10	0-40"/0-1000mm	Without Thumb Roller	\$1740.00	<b>\$1,653.00</b>

Order No.	Description	List Price	Sale Price
959149	40" Caliper Cable	\$49.25	<b>\$46.80</b>
959150	80" Caliper Cable	\$55.20	<b>\$52.45</b>



### AOS Absolute Digimatic Calipers

A new series of digimatic calipers derived from 30 years of accumulated Mitutoyo technologies. Equipped with the electromagnetic induction type absolute encoder and AOS (Advanced Onsite Sensor) applied for ABS coolant-proof calipers.

### Features

- Electromagnetic inductive sensor improves environmental resistance against dirt, water and oil
- A battery life of approximately 3.5 years has been achieved under normal use through the adoption of Mitutoyo's ABSOLUTE scale.
- The slider configuration features an ergonomic, thumb-friendly shape.
- Step-measurement capable.
- Carbide-tipped jaw models are ideally suited to the measurement of rough-machined workpieces, castings, grindstones, etc.
- The data output function allows integration into statistical process control and measurement systems.
- Display character height: 9mm

## ABSOLUTE Solar Calipers

Order No.	Range	Description	List Price	Sale Price
500-474	0-6"/0-150mm	w/o output	\$195.00	<b>\$185.25</b>
500-475	0-8"/0-200mm	w/o output	\$254.00	<b>\$241.30</b>

High quality guide surface finish for smooth slider movement

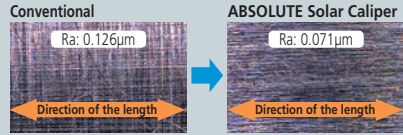

**ABSOLUTE™**

### Features

- Absolute Encoder Technology
- No battery needed
- Works in low lighting conditions above 60 lux
- 0.0005"/0.01mm resolution
- Supplied in fitted plastic case



Order No.	Description	List Price	Sale Price
959149	40" Caliper Cable	\$49.25	<b>\$46.80</b>
959150	80" Caliper Cable	\$55.20	<b>\$52.45</b>



## Digimatic Carbon Fiber Calipers

### Features

- Lightweight Digimatic Calipers that employ CFRP (Carbon Fiber Reinforced Plastics) in the beam and jaws.
- Highly durable and easy to handle.
- Direct readout of ID measurements from the LCD. (Offset value can be set easily by pressing the Offset key.)
- Preset function for setting a desired starting point.
- With SPC data output.
- Special models available with ceramic jaws which are suitable for measuring abrasive and magnetic products.
- Supplied in fitted wooden case.
- .0005"/0.01mm Resolution



Order No.	Range	List Price	Sale Price
552-314-10	40"/1000mm	\$1,890.00	<b>\$1,701.00</b>
552-315-10	60"/1500mm	\$2,260.00	<b>\$2,034.00</b>
552-316-10	80"/2000mm	\$3,540.00	<b>\$3,186.00</b>

Order No.	Description	List Price	Sale Price
05CZA624	40" IP Caliper Cable	\$93.90	<b>\$89.20</b>
05CZA625	80" IP Caliper Cable	\$95.35	<b>\$90.60</b>



## MyCAL Lite Digital Calipers



### Features

- Economically priced
- Large LCD digits
- 0.01"/0.1mm resolution
- Accuracy:  $\pm 0.005"/\pm 0.2\text{mm}$

Order No.	Range	List Price	Sale Price
700-113-10	0-6"/0-150mm	\$116.00	<b>\$92.80</b>
700-123-10	0-8"/0-200mm	\$178.00	<b>\$142.40</b>

## Mitutoyo Caliper Production

Mitutoyo's high quality calipers are designed and built in our Utsunomiya, Japan factory. These tools begin as specially developed stainless steel sheets, which are then laser cut to the general shape seen in the finished part. The frames and sliders, once laser cut, are machined to final size permitting assembly in our highly automated production facility. Once completed, each caliper is thoroughly inspected and tested to ensure the high precision and quality a Mitutoyo customer deserves. Each caliper is packaged with its own unique certificate of inspection as further proof of its quality.

**Mitutoyo Quality**

## Dial Calipers



### Features

- Stainless Steel
- Mitutoyo has improved the durability of its calipers by using a TiN coating on the sliding surfaces of the 6" and 8" main beam.
- .001" graduations
- New designed dial movement for ultra smooth sliding and high shock protection.
- Titanium Nitride (TiN) coating is applied to the sliding surface to increase wear resistance (except for 0 - 12" and 0 - 300mm model).
- Lock screw for dial bezel and for holding the sliding jaw position.
- Can measure OD, ID, depth, and steps.
- Models available with carbide-tipped OD and ID jaws.
- Supplied in fitted plastic case.

Order No.	Range	Remarks	List Price	Sale Price
505-674	4" .100"/rev.		\$103.00	<b>\$92.70</b>
505-675	6" .100"/rev.		\$121.00	<b>\$108.90</b>
505-675-51	6" .100"/rev.	Blue Face	\$121.00	<b>\$108.90</b>
505-675-55	6" .100"/rev.	Orange Face	\$121.00	<b>\$108.90</b>
505-675-66	6" .100"/rev.	Black Face w/ Ratchet Stop	\$130.00	<b>\$117.00</b>
505-689	6" .100"/rev.	Extra Smooth Movement	\$153.00	<b>\$137.70</b>
505-712	6" .100"/rev.	Carbide Tipped Jaws	\$207.00	<b>\$186.30</b>
505-717	6" .200"/rev.		\$111.00	<b>\$99.90</b>
505-676	8" .100"/rev		\$177.00	<b>\$159.30</b>
505-690	8" .100"/rev	Extra Smooth Movement	\$202.00	<b>\$181.80</b>
505-677	12" .100"/rev		\$281.00	<b>\$252.90</b>
505-720	12" .200/rev		\$261.00	<b>\$234.90</b>

## Vernier Caliper

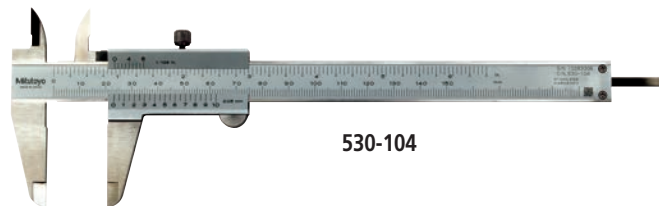

### Features

- Can measure OD, ID, depth and steps
- The small vernier face angle (14°) provides easy reading.
- Dual reading scales on vernier..
- Lock screw for holding the sliding jaw position.
- Carbide-tipped jaw type calipers are also available.
- Supplied with vinyl holster in fitted carton. Except 24" / 600mm models are carton only. 40" / 1000mm supplied in wooden case.

Order No.	Range	Vernier Graduation		Remarks	List Price	Sale Price
		Lower Scale	Upper Scale			
530-104	0 - 150mm / 0 - 6"	0.05mm	1/128"		\$75.90	<b>\$68.30</b>
530-312*	0 - 150mm / 0 - 6"	0.02mm	.001"	High accuracy model	\$105.00	<b>\$94.50</b>
530-114	0 - 200mm / 0 - 8"	0.05mm	1/128"		\$124.00	<b>\$111.60</b>
530-118*	0 - 200mm / 0 - 8"	0.02mm	.001"	High accuracy model	\$124.00	<b>\$111.60</b>
530-115	0 - 300mm / 0 - 12"	0.05mm	1/128"		\$237.00	<b>\$213.30</b>
530-119*	0 - 300mm / 0 - 12"	0.02mm	.001"	High accuracy model	\$232.00	<b>\$208.80</b>

\* Graduation 0.02mm

### Measurement Applications

1. Outside measurement

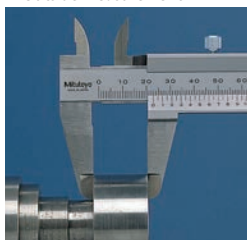

2. Inside measurement

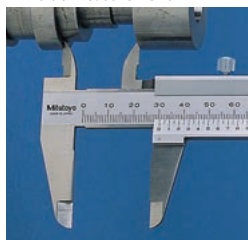

3. Step measurement



4. Depth measurement

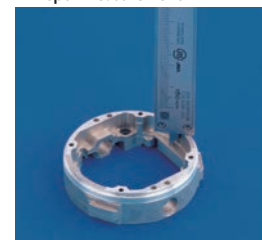



## Inside Micrometers



141-208 Inside Micrometer

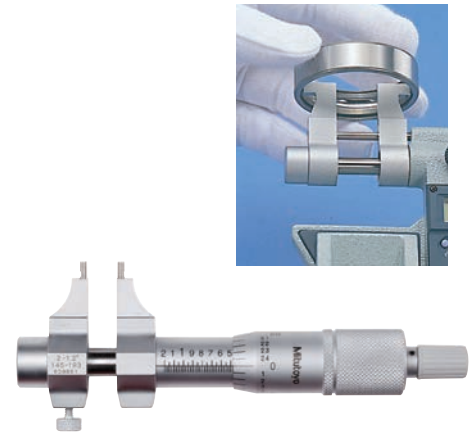

145-193 Caliper Type Inside Micrometer

Order No.	Range	Graduations	Style	List Price	Sale Price
141-208	2-8"	.001"	Inside Micrometer	\$195.00	<b>\$175.50</b>
145-193	.2-1.2"	.001"	Caliper Type Inside Micrometer	\$244.00	<b>\$219.60</b>



### Optional Accessories

- 05CZA662:** SPC cable with data switch 1m / 40"
- 05CZA663:** SPC cable with data switch 2m / 80"
- : Setting ring
- 300401:** Cap for stand holder
- 300400:** Stand holder

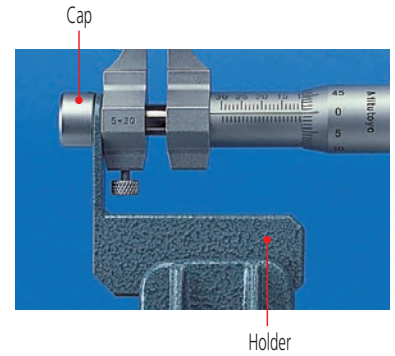

## Bore Gages

### Features

- Most popular Bore Gages.
- Carbide-tipped contact points for durability.
- The dial indicator is fully protected by a rugged cover.
- Optional extension rods can be attached for measuring deep holes.

Order No	Range	Graduation (Indicator)	List Price	Sale Price
511-751	.7 - 1.4"	.0001" (2923SB-10)	\$411.00	<b>\$369.90</b>
511-752	1.4 - 2.5"		\$401.00	<b>\$360.90</b>
511-753	2.0 - 6.0"		\$438.00	<b>\$394.20</b>
511-754	4.0 - 6.5"		\$579.00	<b>\$521.10</b>
511-755	6.5 - 10"		\$652.00	<b>\$586.80</b>
511-756	10 - 16"		\$776.00	<b>\$698.40</b>



511-751

### Optional Accessories

- 953549:** 125mm / 4.92" Extension rod for 18-35mm / .7 - 1.4" models
- 953552:** 125mm / 4.92" Extension rod for 35-160mm / 1.4 - 6.5" models
- 953557:** 125mm / 4.92" Extension rod for 160-400mm / 6.5 - 16" models
- 953550:** 250mm / 9.84" Extension rod for 18-35mm / .7 - 1.4" models
- 953553:** 250mm / 9.84" Extension rod for 35-160mm / 1.4 - 6.5" models
- 952361:** 250mm / 9.84" Extension rod for 160-400mm / 6.5 - 16" models
- 953551:** 500mm / 19.69" Extension rod for 18-35mm / .7 - 1.4" models
- 953554:** 500mm / 19.69" Extension rod for 35-160mm / 1.4 - 6.5" models
- 953558:** 500mm / 19.69" Extension rod for 160-400mm / 6.5 - 16" models
- 953555:** 750mm / 29.53" Extension rod for 35-160mm / 1.4 - 6.5" models
- 953559:** 750mm / 29.53" Extension rod for 160-400mm / 6.5 - 16" models
- 953556:** 1000mm / 39.37" Extension rod for 35-160mm / 1.4 - 6.5" models
- 953560:** 1000mm / 39.37" Extension rod for 160-400mm / 6.5 - 16" models

## Holtest Sets

### Complete Unit Sets

- Each set includes complete gages (micrometer head units and measuring heads for each size).

### Features

- TiN-coated measuring contact points (over 6mm / .275" range models) provide excellent durability and impact resistance and allow the instrument to measure to the bottom of a blind hole (up to 100mm / 4" models).
- Highly durable because of carbide-tipped contact points (anvils up to 12mm / .5" models).
- Can measure deep holes using an Extension rod (optional) which is available on models over 6mm (.275") measuring range.
- With Ratchet Stop for constant force.
- Setting Rings for zero point adjustment are optional.
- Supplied in fitted plastic case up to 100mm / 4". Over 100mm / 4" supplied in wooden case.



368-917

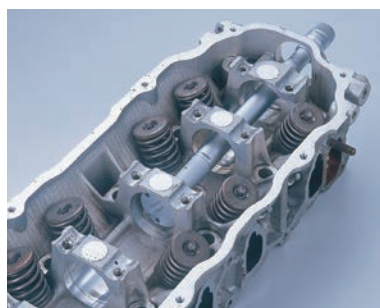

Order No.	Range	Individual Range	Setting Rings Included	Remarks	List Price	Sale Price
368-917	.5" - .8"	.5-.65", .65-.8"	.65" DIA.	With Extension Rod	\$1,490.00	<b>\$1,341.00</b>
368-918	.8" - 2"	.8-1", 1-1.2", 1.2-1.6", 1.6-2"	1" DIA., 1.6" DIA.		\$3,410.00	<b>\$3,069.00</b>
368-919	2" - 4"	2-2.5", 2.5-3", 3-3.5", 3.5-4"	2.5" DIA., 3.5" DIA.		\$4,860.00	<b>\$4,374.00</b>
368-920	4" - 8"	4-5", 5-6", 6-7", 7-8"	5" DIA., 7" DIA.		\$7,440.00	<b>\$6,696.00</b>

## Borematic Sets

### Complete Unit Sets

- Each set includes complete gages (micrometer head units and measuring heads for each size).

### Features

- TiN-coated measuring contact points provide excellent durability and impact resistance and allow the instrument to measure to the bottom of a blind hole.
- Large LCD digits of 8.5mm height for error-free reading.
- 330-degree rotatable display unit for easy reading at any angle.
- GO/NO-GO judgment function.
- The ABSOLUTE linear encoder eliminates over-speed errors.
- With SPC data output.
- Setting rings for origin point setting are optional.
- Can measure deep holes by attaching an optional extension rod.
- Measurement can be taken closer to the bottom of a blind bore.
- Supplied in fitted wooden case.



TiN coated contact points (\*-10" suffix models only)

Order No.	Range	Display Unit	Setting Rings Included	List Price	Sale Price
568-928	.275" - .5" / 6.985 - 12.7mm	568-015	177-179 (.35" DIA.) 177-283 (.425" DIA.)	\$2,230.00	<b>\$2,007.00</b>
568-929	.5" - 1" / 12.7 - 25.4mm		177-182 (.65" DIA.) 177-287 (.8" DIA.)	\$2,530.00	<b>\$2,277.00</b>
568-930	1" - 2" / 25.4 - 50.8mm		177-289 (1.2" DIA.) 177-291 (1.6" DIA.)	\$3,080.00	<b>\$2,772.00</b>
568-936	2" - 4" / 50.8 - 101.6mm		177-315 (2.5" DIA.) 177-319 (3.5" DIA.)	\$4,440.00	<b>\$3,996.00</b>



568-928

Order No.	Description	List Price	Sale Price
905338	40" SPC Cable	\$40.05	<b>\$38.05</b>
905409	80" SPC Cable	\$47.75	<b>\$45.35</b>



## Digimatic Holtest

### Features

- TiN-coated measuring contact points provide excellent durability and impact resistance and allow the instrument to measure to the bottom of a blind hole ( up to 100mm / 4" models).
- Large LCD readout.
- Functions available: Presetting, Zero/ABS, Auto power On/Off, Data hold, Data output, Error alarm, Battery replacement alarm.
- With Ratchet Stop for constant force.
- Can measure deep holes by attaching an Extension rod (optional).
- Setting rings for origin point setting are optional.
- Supplied in fitted plastic case up to 100mm / 4". Over 100mm / 4" supplied in wooden case.



468-261



468-263



468-274

Order No	Range	Accuracy	List Price	Sale Price
468-261	.275 - .35" / 6.925 - 8.89mm	±.0001"	\$1,110.00	<b>\$999.00</b>
468-262	.35 - .425" / 8.89 - 10.795mm	±.0001"	\$1,110.00	<b>\$999.00</b>
468-263	.425 - .5" / 10.795 - 12.7mm	±.0001"	\$1,120.00	<b>\$1,008.00</b>
468-264	.5 - .65" / 12.7 - 16.51mm	±.0001"	\$1,220.00	<b>\$1,098.00</b>
468-265	.65 - .8" / 16.51 - 20.32mm	±.0001"	\$1,220.00	<b>\$1,098.00</b>
468-266	.8 - 1" / 20.32 - 25.4mm	±.00015"	\$1,250.00	<b>\$1,125.00</b>
468-267	1 - 1.2" / 25.4 - 30.48mm	±.00015"	\$1,250.00	<b>\$1,125.00</b>
468-268	1.2 - 1.6" / 30.48 - 40.64mm	±.00015"	\$1,280.00	<b>\$1,152.00</b>
468-269	1.6 - 2" / 40.64 - 50.8mm	±.00015"	\$1,290.00	<b>\$1,161.00</b>
468-270	2 - 2.5" / 50.8 - 63.5mm	±.00015"	\$1,400.00	<b>\$1,260.00</b>
468-271	2.5 - 3" / 63.5 - 76.2mm	±.00015"	\$1,400.00	<b>\$1,260.00</b>
468-272	3 - 3.5" / 76.2 - 88.9mm	±.00015"	\$1,420.00	<b>\$1,278.00</b>
468-273	3.5 - 4" / 88.9 - 101.6mm	±.00015"	\$1,440.00	<b>\$1,296.00</b>
468-274	4 - 5" / 101.6 - 127mm	±.00025"	\$1,880.00	<b>\$1,692.00</b>
468-275	5 - 6" / 127 - 152.4mm	±.00025"	\$1,930.00	<b>\$1,737.00</b>
468-276	6 - 7" / 152.4 - 177.8mm	±.00025"	\$2,050.00	<b>\$1,845.00</b>
468-277	7 - 8" / 177.8 - 203.2mm	±.00025"	\$2,140.00	<b>\$1,926.00</b>
468-278	8 - 9" / 203.2 - 228.6mm	±.00025"	\$2,280.00	<b>\$2,052.00</b>
468-279	9 - 10" / 228.6 - 254mm	±.00025"	\$2,330.00	<b>\$2,097.00</b>
468-280	10 - 11" / 254 - 279.4mm	±.00025"	\$2,410.00	<b>\$2,169.00</b>
468-281	11 - 12" / 279.4 - 304.8mm	±.00025"	\$2,520.00	<b>\$2,268.00</b>

### Optional Accessories

04AZB157: Mounting plate for stand

156-101-10: Stand

952322: Extension rod 100mm / 3.94"  
For range 6-12mm / .275 - .5" models

952621: Extension rod 150mm / 5.9"  
For range 12-20mm / .5" - .8" models

952622: Extension rod 150mm / 5.9"  
For range 20-50mm / .8" - 2" models

952623: Extension rod 150mm / 5.9"  
For range 50-300mm / 2" - 12" models



04AZB157

Order No.	Description	List Price	Sale Price
05CZA662	40" IP65 Mic Cable	\$83.80	<b>\$79.60</b>
05CZA663	80" IP65 Mic Cable	\$92.45	<b>\$87.85</b>





## Digimatic Depth Gage

### Features

- ABSOLUTE Digimatic Depth Gage can keep track of the origin point once set for the entire life of the battery
- Base and measuring faces are hardened and micro-lapped.
- Optional wider extension base are available. (up to 18"/450mm range models)
- With SPC data output.



Order No.	Range	List Price	Sale Price
571-212-20	0-8"/0-200mm	\$426.00	<b>\$404.70</b>
571-213-10	0-12"/0-300mm	\$492.00	<b>\$467.40</b>



Order No.	Description	List Price	Sale Price
959149	40" Depth Gage Cable	\$49.25	<b>\$46.80</b>
959150	80" Depth Gage Cable	\$55.20	<b>\$52.45</b>

## Depth Micrometers

### Features

- Interchangeable rods, with lapped measuring end, provide a wide measuring range.
- The rod length can be interchanged in 1" increments.
- With ratchet stop for constant force.
- With measuring rod clamp.
- Supplied in fitted plastic case.

Order No.	Range	Graduations	Remarks	List Price	Sale Price
129-127	0-4"	.001"	2.5" Base	\$187.00	<b>\$168.30</b>
129-131	0-4"	.001"	4" Base	\$207.00	<b>\$186.30</b>
129-128	0-6"	.001"	2.5" Base	\$226.00	<b>\$203.40</b>
129-149	0-12"	.001"	2.5" Base	\$398.00	<b>\$358.20</b>
129-150	0-12"	.001"	4" Base	\$416.00	<b>\$374.40</b>



## Tire Tread Depth Gage



### Features

- Specially Designed to measure tire tread depth
- Plastic construction for light-weight use
- .001"/0.1mm resolution
- Accuracy:  $\pm .008$ "

Order No.	Range	List Price	Sale Price
700-105	0-1"/0-25.4mm	\$75.20	<b>\$71.45</b>

## Quick Mini

Quick Mini is a convenient snap-action pocket thickness gage offering LCD digital readout. Quick Mini is ideal for rapid checking of a wide variety of materials including metal, paper, plastics and wood.



Order No.	Range	Resolution	List Price	Sale Price
700-118-20	0-.5"/0-12.7mm	.0005"/0.01mm	\$118.00	<b>\$106.20</b>



## Series One Dial Indicators

Mitutoyo's Dial Indicators now offer users more stability and longer life, thanks to advances to the inner workings of the rack and pinion gear system. Shock resistance is increased with a more robust gear train, while contamination resistance has been dramatically increased over other indicators of this type with a tighter seal around the bezel and frame, and the elimination of a lifting lever screw.



Order No.	Graduation	Range	Accuracy	Dial Face	List Price	Sale Price
1410S	.001"	.25"	±.001"	0-100	\$108.00	<b>\$97.20</b>
1410S-10**	.001"	.25"	±.001"	0-100	\$112.00	<b>\$100.80</b>
1410SB*	.001"	.25"	±.001"	0-100	\$108.00	<b>\$97.20</b>
1506S	.0005"	.125"	±.0005"	0-50	\$99.80	<b>\$94.80</b>
1507S	.0005"	.125"	±.0005"	0-25-0	\$99.80	<b>\$94.80</b>

\* with flat back \*\* jeweled

## Series Two Dial Indicators

Order No.	Graduation	Range/Rev	Type	Dial Reading	Accuracy First 2.5 Rev/Overall	Force	List Price	Sale Price
2358S-10	.0001"	.5" / .01"	w/lug	0-10	.0001 / .0008	2.0N or less	\$220.00	<b>\$209.00</b>
2046S	0.01mm	10mm/1mm	w/lug	0-100	0.013mm	1.4N or less	\$114.00	<b>\$108.30</b>
2416S	.001"	1" / .1"	w/lug	0-100	.001 / .002	1.8N or less	\$119.00	<b>\$113.05</b>
2416S-10	.001"	1" / .1"	w/lug	0-100	.001 / .002	1.8N or less	\$141.00	<b>\$133.95</b>
2424S-19	.001"	2" / 1"	w/lug	0-100	.001 / .003	2.5N or less	\$220.00	<b>\$209.00</b>
2776S	.0005"	1" / .05"	w/lug	0-50	.0005 / .002	2.5N or less	\$142.00	<b>\$134.90</b>



## "Quick-Set" Test Indicators

The most direct gear train design ever applied to Test Indicators means— higher levels of sensitivity, reliability, repeatability and accuracy throughout tool life.

### Features

- Anti-magnetic
- Jeweled bearings
- No-clutch structure
- Water and dust resistant
- Glare-free crystal with scratch-resistant coating
- Metric dial faces in yellow
- Measuring force 0.3N or less

Order No.	Graduation	Range	Dial Face	Remarks	List Price	Sale Price
513-402	.0005"	.030"	0-15-0	Anti Magnet, Jeweled	\$130.00	<b>\$123.50</b>
513-402T	.0005"	.030"	0-15-0	Set	\$154.00	<b>\$146.30</b>
513-412	.0005"	.030"	0-15-0	Long Point	\$186.00	<b>\$176.70</b>
513-412T	.0005"	.030"	0-15-0	Long Point Set	\$215.00	<b>\$204.25</b>
513-403	.0001"	.008"	0-4-0	Basic	\$169.00	<b>\$160.55</b>
513-403T	.0001"	.008"	0-4-0	Anti Magnet, Full Set, Jeweled	\$198.00	<b>\$188.10</b>



## Ruby Stylus Test Indicator

### Features

- Wear characteristic improved by 50%.
- Non-magnetic and non-conductive material, enable its use in EDM operation

Contact Point diameter: .079"  
Stem diameter: Ø3/8"

Order No.	Graduation	Range	Force	Accuracy	List Price	Sale Price
513-472	.0005"	.03"	.072N or less	±.0005"	\$145.00	<b>137.75</b>







## IDC Digimatic Indicators

### Features

- Absolute Encoder ensures all settings and readings maintained for the life of the battery (even when the power is turned off)
- Preset, Zero-Set, inch/mm, +/- direction and GO/±NG functions
- Face rotates 330° for use at various angles
- Stem diameter: .375"
- Immune to overspeed error
- SPC output provided
- Average battery life 7,000 hours using SR-44 battery (541980)

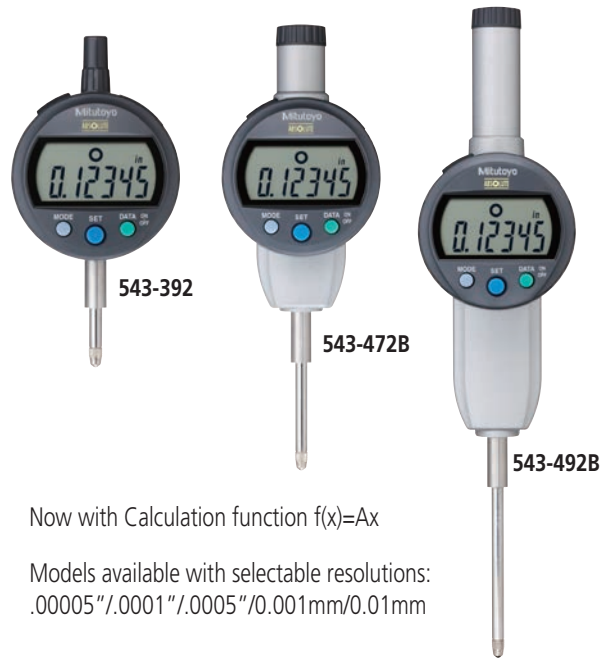

Now with Calculation function  $f(x)=Ax$

Models available with selectable resolutions:  
.00005"/.0001"/.0005"/0.001mm/0.01mm

Order No.	Range	Remarks	List Price	Sale Price
<b>.0005"/0.01mm Resolution</b>				
543-402	.500"/12.7mm	Lug Back	\$310.00	<b>\$294.50</b>
543-402B	.500"/12.7mm	Flat Back	\$310.00	<b>\$294.50</b>
543-476B	1"/25mm	Flat Back	\$454.00	<b>\$431.30</b>
543-496B	2"/50mm	Flat Back	\$597.00	<b>\$567.15</b>
<b>.00005"/.0001"/.0005"/0.001mm/0.01mm Resolution</b>				
543-392	.500"/12.7mm	Lug Back	\$424.00	<b>\$402.80</b>
543-392B	.500"/12.7mm	Flat Back	\$424.00	<b>\$402.80</b>
543-472B	1"/25mm	Flat Back	\$568.00	<b>\$539.60</b>
543-492B	2"/50mm	Flat Back	\$713.00	<b>\$677.35</b>

Order No.	Description	List Price	Sale Price
905338	40" Cable for Indicators	\$40.05	<b>\$38.05</b>
905409	80" Cable for Indicators	\$47.75	<b>\$45.35</b>

### • Three large buttons

The popular three-large button design, which is used in products such as the ABS coolant proof Digimatic indicators ID-N/B, makes buttons easier to press and operations easier to perform.

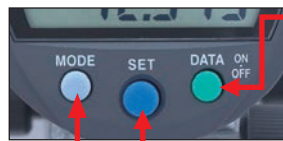

### • Parameter setting mode

Count direction switching, tolerance judgment setting, resolution switching, scale factor setting, and function lock setting

- inch/mm conversion (inch/mm models)

### • Power switch

- Data output (when connected to an external device)
- Data hold (when no external device is connected)

Switches between the ABS (preset) and INC (zeroset) measurement modes

### • 330° rotary display

The display can be rotated 330°, allowing use at a position where you can easily read the measurement value.

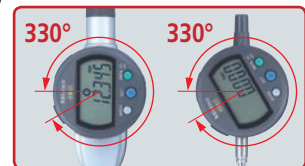

543-793

**ABSOLUTE™**

## IDS Digimatic Indicators with Absolute Encoder

Order No.	Range	Resolution	Remarks	List Price	Sale Price
543-793	0-.5"/0-12.7mm	.0001"/0.001mm	Lug Back	\$273.00	<b>\$259.35</b>
543-793B	0-.5"/0-12.7mm	.0001"/0.001mm	Flat Back	\$273.00	<b>\$259.35</b>
543-792	0-.5"/0-12.7mm	.00005"/0.001mm	Lug Back	\$273.00	<b>\$259.35</b>
543-792B	0-.5"/0-12.7mm	.00005"/0.001mm	Flat Back	\$273.00	<b>\$259.35</b>
543-783	0-.5"/0-12.7mm	.00005"/0.001mm	Lug Back	\$177.00	<b>\$168.15</b>
543-783B	0-.5"/0-12.7mm	.00005"/0.001mm	Flat Back	\$177.00	<b>\$168.15</b>

### Functions:

Origin-set Zeroset, ± Counting, Power ON/OFF Data output, inch/mm conversion

Order No.	Description	List Price	Sale Price
905338	40" Cable for Indicators	\$40.05	<b>\$38.05</b>
905409	80" Cable for Indicators	\$47.75	<b>\$45.35</b>



# Height Gages

## QM-Height High Precision ABSOLUTE Digital Height Gage

The new world standard in height measurement!

### Features

- New generation high accuracy / high resolution ABSOLUTE linear encoder for position detection
- New higher accuracy -  $\pm(2.4 + 2.1L / 600)\mu\text{m}$
- New pneumatic flotation system / positioning grip – allows for smooth movement along surface plate (select models)
- New large, stationary display panel with user friendly icon control keys and GO/NG LED indicator
- Digital and USB Output (New) – Supports Mitutoyo wireless SPC Output
- Long battery life with standard AA batteries (4) – Up to 300 hours (80 hours with regular use of pneumatic flotation function)
- Fully compatible with existing Mitutoyo Digimatic peripherals (SPC Cables, U-Wave wireless transmitters, multiplexers, etc.



### Go/±NG judgment by LED (red, orange, green) and measurement examples

- LEDs are activated at the time of tolerance judgment – green for Go, red for +NG, and orange for -NG. "-NG", "GO" and "+NG" also appear on the LCD.



### FREE Accessories with Package (\$698.00 Total Value)



**12AAC072**  
Depth Stylus  
(\$198.00 value)



**K650986**  
Stylus Kit  
(\$500.00 value)

Order No.	Range	Accuracy	Resolution	Remarks	List Price
PROMO003	0 - 14" / 0 - 350mm	$\pm(2.4+2.1L/600)\mu\text{m}$ L = Measuring length (mm)	0.001mm / 0.0005mm /.00005" / .0001"		\$3,990.00
PROMO004	0 - 24" / 0 - 600mm				\$4,490.00
PROMO005	0 - 14" / 0 - 350mm			Pneumatic Floatation System	\$4,490.00
PROMO006	0 - 24" / 0 - 600mm			Pneumatic Floatation System	\$4,990.00



## Linear Height LH-600E

The Mitutoyo Linear Height LH-600E offers advanced performance for reliable and easy 2D measurement.

Measuring Range (stroke) 0–38" (24") / 0–972mm (600mm)

### Features

- True 2-D measurement
- High Accuracy:  $(1.1+0.6L/600)\mu\text{m}$  (L=Length of mm)
- Measuring Range (Stroke): 0-38" (24"), 0-972mm (600mm)
- Selectable Resolution: .000001"/.00001"/.0001"/.001"/0.0001mm /0.001mm/0.01mm/0.1mm
- Basic statistical functions are provided
- RS-232C / USB data output provides the option of evaluating measurement data externally with SPC software on a PC
- One-key operation for running semiautomatic measurement
- Data entry from a Digimatic tool
- Highest functionality: 21 parameters
- Accepts 7 different probes
- Pneumatic full/semi floating system
- Holds 60,000 data points
- Memory for 50 measuring points
- Bright, back-lit LCD



Order No.	Description	List Price	Sale Price
518-351A-21	Linear Height Gage	\$8,480.00	<b>\$7,632.00</b>

### Frequently used measurements

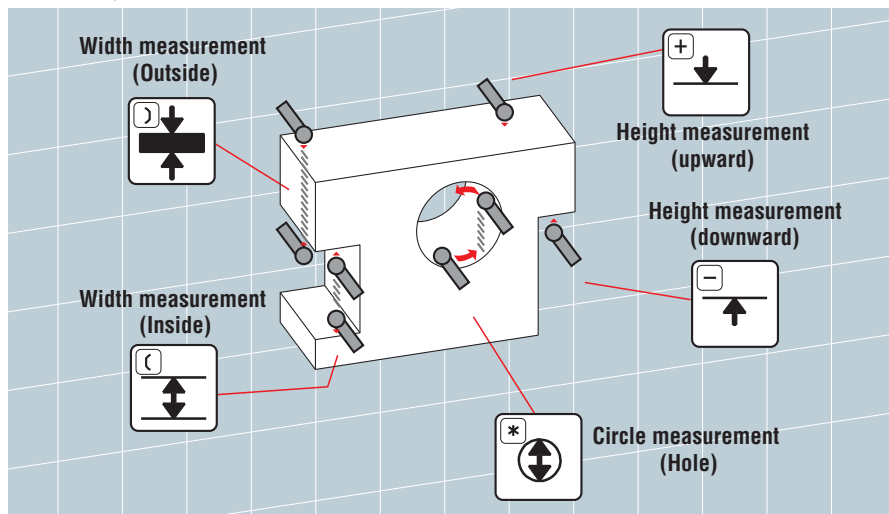

Optional thermal printer



Scan this code to view a demo video of the Linear Height LH 600E



Numerous optional probes enable many types of measurement





## Digimatic Height Gages (Multi-Function Type)

Now with two resolutions and two value preset memory and increased character height for easier viewing.

### Features

- Highly versatile multi-function type.
- Carbide-tipped long scriber is provided.
- Rigid construction ensures repeatable measurement.
- Switchable resolution.
- Coarse/fine feed switching.
- With SPC data output.
- Two preset reference height.

Order No.	Range	Resolution	Accuracy	List Price	Sale Price
192-670-10	0-12"/0-300mm	.0005" (0.01mm) [.0002" (0.005mm) Switchable]	±001"	\$1,770.00	<b>\$1,593.00</b>
192-671-10	0-18"/0-450mm		±0015"	\$2,280.00	<b>\$2,052.00</b>
192-672-10	0-24"/0-600mm		±0015"	\$2,920.00	<b>\$2,628.00</b>
192-673-10	0-40"/0-1000mm		±0025"	\$5480.00	<b>\$4,932.00</b>



Order No.	Description	List Price	Sale Price
905338	40" SPC Cable	\$40.05	<b>\$38.05</b>
905409	80" SPC Cable	\$47.75	<b>\$45.35</b>



192-670-10

### Functions include:

- Zero/ABS setting (ABS and INC modes)
- 2 Value Preset Memory
- Data hold
- ± Counting
- Inch/mm conversion

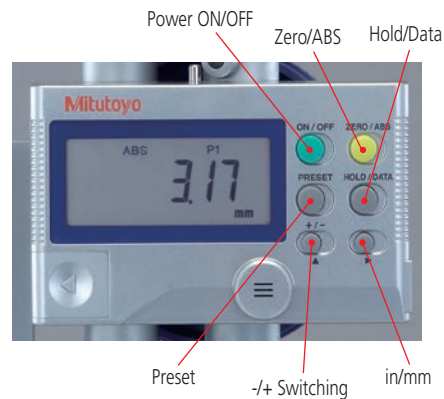

## Digimatic Height Gages (Standard Type)

Now with two resolutions and two value preset memory and increased character height for easier viewing.

Order No.	Range	Resolution	Accuracy	List Price	Sale Price
192-630-10	0-12"/0-300mm	.0005"/0.01mm or .0002"/0.005mm	±.001"	\$1,540.00	<b>\$1,386.00</b>
192-631-10	0-18"/0-450mm		±.002"	\$2,110.00	<b>\$1,899.00</b>
192-632-10	0-24"/0-600mm		±.002"	\$2,690.00	<b>\$2,421.00</b>
192-633-10	0-40"/0-1000mm		±.003"	\$5,080.00	<b>\$4,572.00</b>

### Functions include:

- Zero/ABS setting (ABS and INC modes)
- 2 Value Preset Memory
- Data hold
- ± Counting
- Inch/mm conversion



Order No.	Description	List Price	Sale Price
905338	40" SPC Cable	\$40.05	<b>\$38.05</b>
905409	80" SPC Cable	\$47.75	<b>\$45.35</b>



192-633-10

# Height Gages

## ABSOLUTE Digimatic Height Gages

### Features

- Built in ABSOLUTE linear encoder  
This encoder eliminates the necessity of setting the reference point at every power-on. It has improved reliability because no over-speed error will occur.
- Fine-adjustment carriage to feed the slider finely.
- Carbide-tipped scriber is provided.
- With SPC data output.

Order No.	Range	Accuracy	Resolution	List Price	Sale Price
570-244	0 - 8" / 0 - 200mm	±.001"	.0005" / 0.01mm	\$636.00	<b>\$604.20</b>
570-248	0 - 40" / 0 - 1000mm	±.003"	.0005" / 0.01mm	\$3,790.00	<b>\$3,600.50</b>

Order No.	Range	Accuracy	Resolution	List Price	Sale Price
570-312	0 - 12" / 0 - 300mm	±.0015"	.0005" / 0.01mm	\$627.00	<b>\$595.65</b>
570-313	0 - 18" / 0 - 450mm	±.002"	.0005" / 0.01mm	\$880.00	<b>\$836.00</b>
570-314	0 - 24" / 0 - 600mm	±.002"	.0005" / 0.01mm	\$1,130.00	<b>\$1,073.50</b>



Large smooth slider feed wheel



Large clamp lever

Order No.	Description	List Price	Sale Price
905338	40" SPC Cable	\$40.05	<b>\$38.05</b>
905409	80" SPC Cable	\$47.75	<b>\$45.35</b>



**ABSOLUTE™**



## Dial Height Gages

Double-column structure ensures high measuring accuracy. Coarse/ Fine Feed switching. Carbide-tipped scriber.

### Features

- Easy and error-free reading with both up and down digital counters as well as a dial.
- Provided with a feed wheel for easy coarse feeding.
- Carbide-tipped scriber is provided.
- The counters and dial can be re-zeroed at any scriber position.



192-150

Order No.	Range	Graduation	List Price	Sale Price
192-150	0-12"	.001"	\$1,010.00	<b>\$909.00</b>
192-151	0-18"	.001"	\$1,400.00	<b>\$1,260.00</b>
192-152	0 - 24"	.001"	\$1,820.00	<b>\$1,638.00</b>
192-153	0 - 40"	.001"	\$3,990.00	<b>\$3,591.00</b>



Easy and secure clamping



Easy and error free reading

## Rectangular Steel Gage Block Sets



516-902-26

### Gage Block Production

Mitutoyo has been producing gage blocks for more than 70 years. Since the time when the Numata Research laboratory entered the market on a full-scale production basis, the production of Mitutoyo gage blocks now exceeds a total of 23 million pieces in 45 years, and they continue to be used all over the world. Advanced processing techniques have been cultivated by Mitutoyo over the years with its research and development advancing measurement technology and creating new products, such as new types of gage block, as well as leading-edge measuring equipment for gage block evaluation. With a reputation for innovation and reliability endorsed by history, and an extensive sales/service network stretching throughout the world, Mitutoyo continues to support manufacturing industries wherever they may be found.



Order No.	Blocks per Set	Grade	Size	Step	Qty	List Price	Sale Price
516-902-26	81	0	.1001 - .1009"	.0001"	9	\$1,970.00	<b>\$1,773.00</b>
			.101 - .149"	.001"	49		
			.05 - .95"	.05"	19		
			1 - 4"	1"	4		
516-903-26	81	AS-1	.1001-.1009"	.0001"	9	\$1710.00	<b>\$1,539.00</b>
			.101-.149"	.001"	49		
			.05-.95"	.05"	19		
			1-4"	1"	4		
516-904-26	81	AS-2	.1001-.1009"	.0001"	9	1,550.00	<b>\$1,395.00</b>
			.101-.149"	.001"	49		
			.05-.95"	.05"	19		
			1-4"	1"	4		
516-914-26	35	0	.10005"		1	\$1,040.00	<b>\$936.00</b>
			.1001-.1009"	.0001"	9		
			.101-.149"	.001"	9		
			.11-.19"	.01"	9		
			.1-.3"	.1"	3		
516-946-26	87	0	1.001-1.009mm	0.001mm	9	\$2,790.00	<b>\$2,511.00</b>
			1.01 - 1.49mm	0.01mm	49		
			0.5-9.5mm	0.5mm	19		
			10-100mm	10mm	10		
516-947-26	87	AS-1	1.001-1.009mm	0.001mm	9	\$2,460.00	<b>\$2,214.00</b>
			1.01-1.49mm	0.01mm	49		
			0.5-9.5mm	0.5mm	19		
			10-100mm	10	10		

Order No.	Blocks per Set	Grade	Blocks Incl. In Set	Remarks	List Price	Sale Price
516-930-26	9	0	.0625", .100", .125", .200", .250"	Optical parallel (t = .5")	\$360.00	<b>\$324.00</b>
516-931-26	9	AS-1	.300", .500" 1", 2"		\$314.00	<b>\$282.60</b>
516-935-26	9	AS-1	.0625", .100", .125", .200", .250", .300", .500", 1", 2"	Optical parallel (t = .5")	\$242.00	<b>\$217.80</b>

## Square Steel Gage Block Set



Order No.	Blocks per Set	Grade	Size	Step	Qty	List Price	Sale Price
516-402-26	81	0	.1001" - .1009"	0.0001"	9	\$2,820.00	<b>\$2,538.00</b>
			.101" - .149"	0.001"	49		
			.05" - .95"	0.05"	19		
			1" - 4"	1"	4		



## Mitutoyo SPC Cables

Mitutoyo SPC cables for tools with Mitutoyo Digimatic SPC output.



Order No.	Length	Pins	For Use With	List Price	Sale Price
<b>With Data Out Switch</b>					
05CZA624	40"	—	IP66/67 Calipers	\$93.90	<b>\$89.20</b>
05CZA625	80"	—	IP66/67 Calipers	\$95.35	<b>\$90.60</b>
05CZA662	40"	—	IP65 Micrometers	\$83.80	<b>\$79.60</b>
05CZA663	80"	—	IP65 Micrometers	\$92.45	<b>\$87.85</b>
959149	40"	—	Height Gage 570 Series, Digimatic Indicator 543 and 575 Series, Digimatic Scale Unit 572 Series, Digimatic Absolute Calipers	\$49.25	<b>\$46.80</b>
959150	80"	—	Height Gage 570 Series, Digimatic Indicator 543 and 575 Series, Digimatic Scale Unit 572 Series, Digimatic Absolute Calipers	\$55.20	<b>\$52.45</b>
<b>Without Data Out Switch</b>					
937387	40"	6	Borematic 568 Series	\$50.85	<b>\$48.30</b>
965013	80"	6	Borematic 568 Series	\$60.10	<b>\$57.10</b>
905338	40"	—	Height Gage 570 Series, Digimatic Indicator 543 and 575 Series, Digimatic Scale Unit 572 Series	\$40.05	<b>\$38.05</b>
905409	80"	—	Height Gage 570 Series, Digimatic Indicator 543 and 575 Series, Digimatic Scale Unit 572 Series	\$47.75	<b>\$45.35</b>

## Multiplexers – MIG-8USB, MIG-4USB

### Features

- A measurement data transfer device, multiplexer MIG-8USB and MIG-4USB converts digimatic output measurement data to RS-232C and outputs it to an external device such as PC.



64AAB386  
Front view



64AAB386  
Back view

Model No.	MIG-8USB	MIG-4USB
Order No.	64AAB386	64AAB387
Gage Capacity	8	4
Dimension (mm) W x D x H	146 x 150 x 45	146 x 150 x 70
Mass (g)	540	710
List Price	\$1,340.00	\$830.00
Sale Price	<b>\$1,273.00</b>	<b>\$788.00</b>

**MeasurLink** ENABLED  
Data Management Software by Mitutoyo

## Digimatic Mini-Processor

Order No.	Description	List Price	Sale Price
264-504-5A	DP - 1VR	\$506.00	<b>\$480.70</b>



### Features

- This is a palm-sized printer used to print measurement data from the digimatic gage or to perform statistical analysis.
- This printer offers excellent functionality. You can use it not only to print measurement data, perform a variety of statistical analyses, and draw a histogram or D chart but also to perform complicated operations for X-R control chart.
- Equipped with RS-232C output and GO/NG judgment output as standard functions, this processor ensures high reliability as an advanced quality inspection machine.
- The line thermal printer enables fast and quiet printing.



264-504-5A

# USB Input Tool Direct

## Measuring instrument with digimatic output

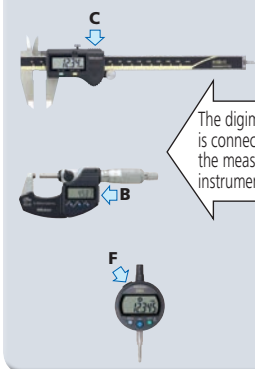

The digimatic plug is connected to the measuring instrument.

## USB-ITN types



Each type of USB-ITN has a unique plug to fit the instrument it is designed for (figures **A** to **G** on the left). Just select the type that fits your measuring instrument (USB-ITN-A, USB-ITN-B,...). Detailed specifications, such as part numbers, are shown on page 5.



The USB plug is connected to a computer.

## Computer

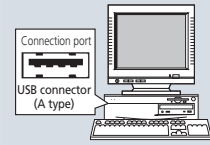

- Supported operating systems:  
Windows 2000 SP4  
Windows XP SP2 or later  
Windows Vista  
Windows 7

**Sale Price**  
**\$177<sup>30</sup>**

Our Regular Price: \$197.00  
For All Input Tools

Determine the plug type suitable for your measuring instrument (one of the seven types from **A** to **G**) in the following table, and then select the corresponding USB Input Tool Direct.

Model	USB-ITN-A	USB-ITN-B	USB-ITN-C	USB-ITN-D	USB-ITN-E	USB-ITN-F	USB-ITN-G
Order No.	06ADV380A	06ADV380B	06ADV380C	06ADV380D	06ADV380E	06ADV380F	06ADV380G
Whether the existence of a data switch affects usability	Incorporates a data switch, so the tool is usable regardless of whether or not the measuring instrument has a switch.			Does not incorporate a data switch, so an instrument fitted with a switch is required in order to use the instrument alone. (However, the tool can be used with USB-ITPAK.)			
Cable type	<b>A</b> Water-proof with switch	<b>B</b> Water-proof with switch	<b>C</b> With switch	<b>D</b> 10-pin plain	<b>E</b> 6-pin round	<b>F</b> Straight type	<b>G</b> Water-proof straight type
Illustration of the plug that connects to the measuring instrument							
Socket type on the measuring instrument							
Codes of major compatible measuring instruments	[Digimatic Caliper /Super Caliper] <b>-500 series</b> <b>-550/551 series</b> [Digimatic Carbon Fiber Caliper] <b>-552 series</b> [Digimatic Depth Gage] <b>-571 series</b> [Digimatic Scale Unit] <b>-572 series</b> [Digimatic Exclusive Caliper] <b>-573 series</b>	[Digimatic Micrometer, QuantuMike] <b>-293series</b> [Tubular Inside Micrometer] <b>-337 series</b> <b>-339 series</b> [Digimatic Micrometer Head] <b>-350 series</b> [Digimatic Exclusive Micrometer] (The end of the mark is-) <b>-468 series</b>	[Digimatic Micrometer Head] <b>-164 series</b> [Digimatic Caliper] <b>-500 series</b> <b>- 550/ 551</b> [Digimatic Depth Gage] <b>-571 series</b> [Digimatic Scale Unit] <b>-572 series</b> [Digimatic Exclusive Caliper] <b>-573 series</b>	Measuring instrument models that incorporate a data switch			[Digimatic Indicator] <b>-543 series</b>
				[Surface Roughness Tester] <b>-178 series</b> [Coating Thickness Gage] <b>-179 series</b> [Linear Height] <b>-518 series</b> [Reference Gage] <b>-515 series</b> [Digimatic Indicator] <b>-543 series</b> [Laser Scan Micrometer] <b>-544 series</b> <b>Digital μ-checker</b> (Using the foot switch)	[Digimatic Micrometer] <b>-121 series</b> <b>-164 series</b> <b>-227 series</b> <b>-293 series</b> [Tubular Inside Micrometer] <b>-337 series</b> [Tubular Inside Micrometer] <b>-339 series</b> [Digimatic Holtest] <b>-468 series</b> [Reference Gage] <b>-515 series</b> [Borematic] <b>-568 series</b> [Hardness Testing Machines] <b>-810 series</b>	[Digimatic Height Gage] <b>-192/570/574 series</b> [Digimatic Caliper] <b>-500/550/551 series</b> [Digimatic Bore Gage] <b>-511 series</b> [Digimatic Indicator] <b>-543 seires</b> [Digimatic Depth Gage/ Digimatic Thickness Gage] <b>-547 series</b> Digimatic model [Digimatic Carbon Fiber Caliper] <b>-552 series</b> [Digimatic Scale Unit] <b>-572 series</b> [Portable Hardness Testing Instruments] <b>-811 series</b>	
				Measuring instrument models that do not have a data switch			
				[Digimatic Indicator] <b>-543 series</b> <b>ID-F</b> [Linear Gage/Counter] <b>-542 series</b> [Litematic] <b>-318 series</b>	No corresponding models	[Digimatic Indicator] <b>-543 series</b> [Digimatic Depth Gage/ Digimatic Thickness Gage] <b>-547 series</b> Digimatic model <b>-575 series</b>	No corresponding models

# U-Wave Wireless System

## U-Wave Wireless Data Communication System

The U-WAVE system enables easy wireless data communication from a measuring tool to a PC using the Digimatic protocol. Measurement efficiency is improved by eliminating long and cumbersome data cables. The user-friendly interface allows data to be loaded into any software product that accepts keyboard input, such as Excel or Notepad.

### How to "Spec" a U-Wave System:

1. One U-Wave-R required per system (will support up to 100 U-Wave-T): Order No. **02AZD810D**
2. One U-Wave-T required per tool: Order No. **02AZD730D**
3. Select the required connecting cable (cable length approx. 6").  
Use the convenient U-Wave Cable Selection Chart to convert your existing cable part number to the corresponding U-Wave cable order number.

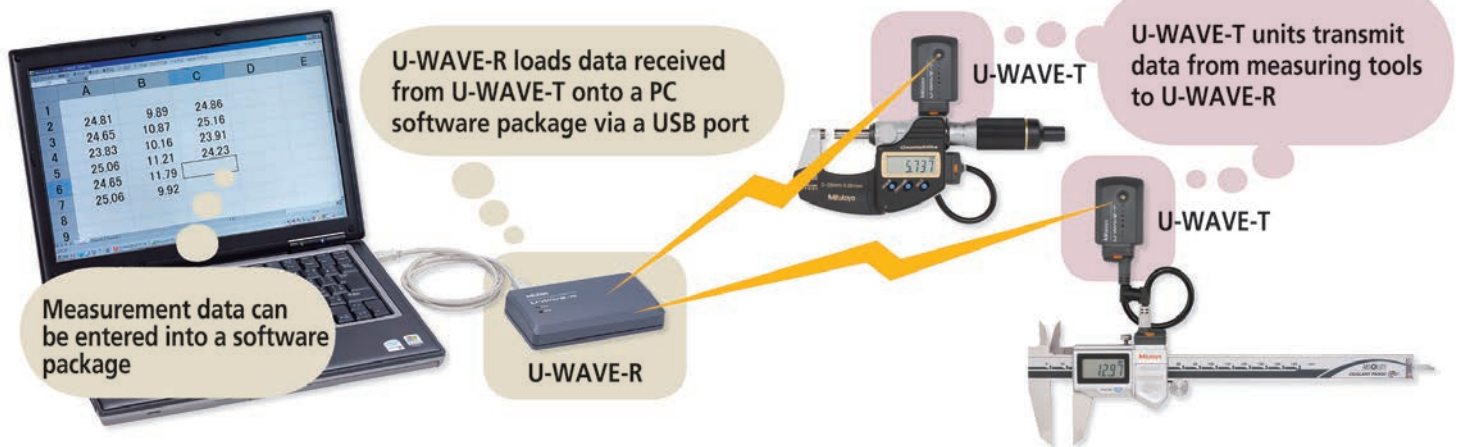

## U-Wave-R

### Features

- Supports up to 100 U-Wave-T
- Comes complete with U-WavePak set-up/data input software.
- U-WavePak, standard with U-Wave-R features a keyboard interface function. This allows measurement data to be easily entered into in Excel, Notepad or other formats that accepts numeric value input via a keyboard.
- Supplied with USB connecting cable.
- MeasurLink® V6.1 Real-Time PLUS supports the U-Wave System.



## U-Wave-T

### Features

- Is IP67 rated
- IP67 cables available for your Mitutoyo waterproof tools.
- Battery life approx. 400,000 data transmissions.
- Up to 60 feet transmission range. Actual range depends on the local radio transmission characteristics.



Order No.	Description	Use For Cables	List Price	Sale Price
<b>02AZD810D</b>	U-Wave-R		\$499.00	<b>\$449.10</b>
<b>02AZD730D</b>	U-Wave-T		\$220.00	<b>\$198.00</b>
<b>02AZD790A</b>	U-Wave Connecting Cable A	05CZA624 or 05CZA625	\$110.00	<b>\$99.00</b>
<b>02AZD790B</b>	U-Wave Connecting Cable B	05CZA662 or 05CZA663	\$110.00	<b>\$99.00</b>
<b>02AZD790C</b>	U-Wave Connecting Cable C	959149 or 959150	\$110.00	<b>\$99.00</b>
<b>02AZD790D</b>	U-Wave Connecting Cable D	936937 or 965014	\$110.00	<b>\$99.00</b>
<b>02AZD790E</b>	U-Wave Connecting Cable E	937387 or 965013	\$110.00	<b>\$99.00</b>
<b>02AZD790F</b>	U-Wave Connecting Cable F	905338 or 905409	\$110.00	<b>\$99.00</b>
<b>02AZD790G</b>	U-Wave Connecting Cable G	21EAA194 or 21EAA190	\$110.00	<b>\$99.00</b>



## MeasurLink® Real Time Data Collection Software

**MeasurLink 7 Real-Time Standard Edition** is designed for customers who want to acquire and analyze data in real-time and check variable and attribute inspection to maximize production and minimize defects. It has views to allow the user to create Parts, Characteristics with nominal and tolerance and Traceability lists. The data collection interface provides real-time graphics for Run charts, Control charts, Histograms and Statistics. Standard views include Datasheet (observations and charts), Classic View (chart windows), and the 2D view (part images with callouts that include charts and statistical data). Full reporting template functionality is also provided. Supported data sources include keyboard, RS232 and USB devices.

**MeasurLink 7 Real-Time Professional Edition** enables customers to connect and acquire data from Mitutoyo Coordinate Measuring Machines, Vision and Form Measuring Systems via native integration (DDE). ASCII and QMD (xml-based) file imports are also supported. In addition to all of the features supported by MeasurLink 7 Real-Time Standard Edition, this application also supports data filters. Full reporting functionality with templates is also provided. Supported data sources include keyboard, RS232C and USB devices, native Mitutoyo integration (DDE), ASCII and QMD (xml-based) file imports.

**MeasurLink 7 Real-Time Professional 3D Edition** is designed for customers who wish to collect data using the Hoops 3D graphics view. Hoops 3D files can be exported from most CAD systems and provides the operator with a real view of the part. Camera angle and position can be saved for each characteristic providing for an intuitive prompted guided sequencing for the inspector. Supported data sources include keyboard, RS232C and USB devices, native Mitutoyo integration (DDE), ASCII and QMD (xml-based) file imports.

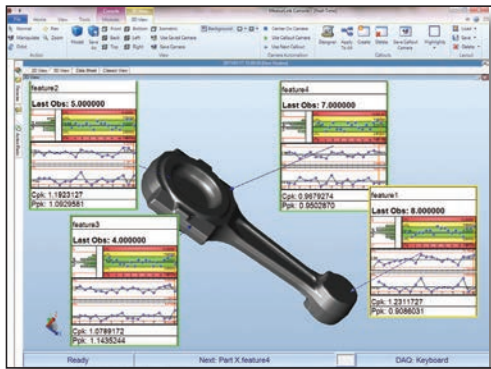

### Database Management System (DBMS) Requirements

MeasurLink 7 ships with a copy of Microsoft® SQL Server Express Edition 2008 R2, this can be for a standalone or a workgroup installation.

MeasurLink 7 also supports the following Microsoft SQL Server versions:

- Microsoft® SQL Server 2008 Standard Edition
- Microsoft® SQL Server 2008 Enterprise Edition
- Microsoft® SQL Server 2005 Workgroup Edition
- Microsoft® SQL Server 2005 Standard Edition

### Operating System Requirements

All MeasurLink 7 products are supported on the following Microsoft® Windows Operating System versions:

- All Windows XP SP3 versions
- All Windows Vista SP2 versions
- All Windows 7 versions
- Both 32bit and 64bit operating systems supported

\*\* Note: All product media will contain installers for both 32bit and 64bit systems

### PC (OS Specific Hardware Requirements (Network))

Windows 7	<ul style="list-style-type: none"> <li>• 1 gigahertz (GHz) or faster 32-bit (x86) or 64-bit (x64) processor</li> <li>• 2 gigabyte (GB) RAM (32-bit)</li> <li>• 16 GB available hard disk space (32-bit) or 20 GB (64-bit)</li> <li>• DirectX 9 graphics device with WDDM 1.0 or higher driver</li> <li>• DVD-ROM drive</li> </ul>
Windows Vista SP2	<ul style="list-style-type: none"> <li>• 1 gigahertz (GHz) 32-bit (x86) or 64-bit (x64) processor</li> <li>• 2 gigabyte (GB) of system memory</li> <li>• 40 GB hard drive with at least 15 GB of available space (20 GB for Home Basic)</li> <li>• Support for DirectX 9 graphics with WDDM and 128 MB of graphics memory</li> <li>• DVD-ROM drive</li> </ul>
Windows XP SP3	<ul style="list-style-type: none"> <li>• 1 gigahertz (GHz) 32-bit (x86)</li> <li>• 1 gigabyte (GB) of system memory</li> <li>• 40 GB hard drive with at least 15 GB of available space</li> <li>• DVD-ROM drive</li> </ul>



Order No.	Description	List price	Sale Price
64AAB177	MEASURLINK V7.0 REAL-TIME STANDARD EDITION	\$1,195.00	<b>\$1,075.00</b>
64AAB178	MEASURLINK V7.0 REAL-TIME PROFESSIONAL EDITION	\$1,795.00	<b>\$1,615.00</b>
64AAB179	MEASURLINK V7.0 REAL-TIME PROFESSIONAL 3D EDITION	\$1,995.00	<b>\$1,795.00</b>

## ABSOLUTE Digimatic Scale Units

### Features

- The ORIGIN key allows setting of an absolute zero point to be used as reference in subsequent measurements. Once set, the ABS Digimatic Scale Unit is ready to show its true position whenever turned on rather than 0.00" as with standard models.
- The ZERO/ABS key allows the display to be zero-set at any slider position along the beam for incremental comparison measurements. This key will also allow return to the absolute coordinate with a display of the true position from the origin point.
- No rack, no pinion, no glass scale. Digimatic Scale Unit is safely embedded in the hardened stainless steel blade.
- Horizontal or vertical face according to the scale mounting direction.
- Special type that is provided with diameter displaying function is available for lathes.
- All units come with two mounting brackets, each located at either end of the scale.
- With SPC data output.

**ABSOLUTE™**

Order No	Model	Range	Accuracy	Resolution	Type	List Price	Sale Price
572-210-20	SD-4"DX	0-4" / 0-100mm	.001" / 0.03mm	.0005" / 0.01mm	Horizontal single-function	\$235.00	<b>\$223.25</b>
572-211-20	SD-6"DX	0-6" / 0-150mm	.001" / 0.03mm	.0005" / 0.01mm	Horizontal single-function	\$249.00	<b>\$236.55</b>
572-212-20	SD-8"DX	0-8" / 0-200mm	.001" / 0.03mm	.0005" / 0.01mm	Horizontal single-function	\$290.00	<b>\$275.50</b>
572-213-10	SD-12"D	0-12" / 0-300mm	.002" / 0.04mm	.0005" / 0.01mm	Horizontal single-function	\$559.00	<b>\$531.05</b>
572-310-10	SD-6"D	0-4" / 0-100mm	.001" / 0.03mm	.0005" / 0.01mm	Vertical single function	\$260.00	<b>\$247.00</b>
572-311-10	SD-6"D	0-6" / 0-150mm	.001" / 0.03mm	.0005" / 0.01mm	Vertical single-function	\$276.00	<b>\$262.20</b>
572-312-10	SD-8"D	0-8" / 0-200mm	.001" / 0.03mm	.0005" / 0.01mm	Vertical single function	\$320.00	<b>\$304.00</b>
572-313-10	SD-12"D	0-12" / 0-300mm	.002" / 0.04mm	.0005" / 0.01mm	Vertical single function	\$616.00	<b>\$585.20</b>
572-474	SD-18"E	0-18" / 0-450mm	.002" / 0.04mm	.0005" / 0.01mm	Horizontal multi-function	\$782.00	<b>\$742.90</b>
572-475	SD-24"E	0-24" / 0-600mm	.002" / 0.04mm	.0005" / 0.01mm	Horizontal multi-function	\$867.00	<b>\$823.65</b>
572-476	SD-32"E	0-32" / 0-800mm	.0025" / 0.06mm	.0005" / 0.01mm	Horizontal multi-function	\$1380.00	<b>\$1,311.00</b>
572-477	SD-40"E	0-40" / 0-1000mm	.0025" / 0.06mm	.0005" / 0.01mm	Horizontal multi-function	\$1500.00	<b>\$1,425.00</b>
572-574	SDV-18"E	0-18" / 0-450mm	.002" / 0.04mm	.0005" / 0.01mm	Vertical multi-function	\$782.00	<b>\$742.90</b>
572-575	SDV-24"E	0-24" / 0-600mm	.002" / 0.04mm	.0005" / 0.01mm	Vertical multi-function	\$867.00	<b>\$823.65</b>
572-576	SDV-32"E	0-32" / 0-800mm	.0025" / 0.06mm	.0005" / 0.01mm	Vertical multi-function	\$1380.00	<b>\$1,311.00</b>
572-577	SDV-40"E	0-40" / 0-1000mm	.0025" / 0.06mm	.0005" / 0.01mm	Vertical multi-function	\$1500.00	<b>\$1,425.00</b>



## Quill Kit with Absolute Encoder

Easy Installation Fits Most Vertical Knee Mills

### Features

- Easy to read LCD with resolution of .0005"/0.01mm. 0-6" Travel inch/mm
- Push button controls for inch/mm, Zero-Set and On/Off.
- Powered by a single SR-44 Battery which lasts about 1 year with normal use.
- SPC Output for data transmission to Data Processors or a Remote Display.

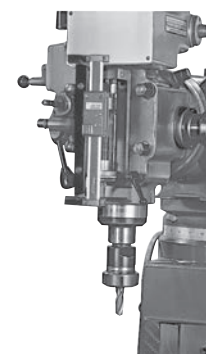
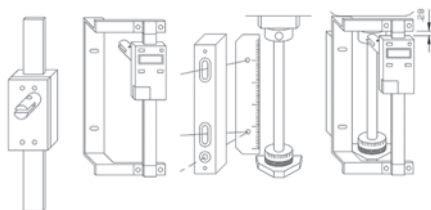

The Mitutoyo Quill Kit mounted on a vertical mill.

Order No.	Description	List Price	Sale Price
053906B	Digimatic Quill Kit complete with brackets & scale for Bridgeport Type machines.	\$306.00	<b>\$275.40</b>



# Digital Readout

Purchase any DRO Package and Receive a **Free** Dial Test Indicator & Flexible Magnetic Stand!\*

## Mitutoyo's Digital Readout Packages

Mounting Hardware Included!



513-406



7012-10



Order No.	Description	X Travel	Y Travel	Z Travel	X Axis type	Y Axis type	Z Axis type	List Price	Sale Price
64PKA058	12" X 30" DRO Mill Pkg	30"	12"		AT715	AT715		\$1,490.00	<b>\$1,341.00</b>
64PKA059	12" X 36" DRO Mill Pkg	36"	12"		AT715	AT715		\$1,490.00	<b>\$1,341.00</b>
64PKA060	14" X 30" DRO Mill Pkg	30"	14"		AT715	AT715		\$1,490.00	<b>\$1,341.00</b>
64PKA061	14" X 40" DRO Mill Pkg	40"	14"		AT715	AT715		\$1,490.00	<b>\$1,341.00</b>
64PKA062	16" X 36" DRO Mill Pkg	36"	16"		AT715	AT715		\$1,490.00	<b>\$1,341.00</b>
64PKA063	16" X 40" DRO Mill Pkg	40"	16"		AT715	AT715		\$1,490.00	<b>\$1,341.00</b>
64PKA064	18" X 40" DRO Mill Pkg	40"	18"		AT715	AT715		\$1,490.00	<b>\$1,341.00</b>
64PKA065	12' x 30" x 6" Mill Pkg	30"	12"	6"	AT715	AT715	AT715	\$2,220.00	<b>\$1,998.00</b>
64PKA066	12' x 36" x 6" Mill Pkg	36"	12"	6"	AT715	AT715	AT715	\$2,220.00	<b>\$1,998.00</b>
64PKA067	16' x 36" x 6" Mill Pkg	36"	16"	6"	AT715	AT715	AT715	\$2,220.00	<b>\$1,998.00</b>
64PKA035	6" X 28" Lathe Pkg	6"		28"	AT116		AT715	\$1,680.00	<b>\$1,512.00</b>
64PKA036	6" X 30" Lathe Pkg	6"		30"	AT116		AT715	\$1,680.00	<b>\$1,512.00</b>
64PKA037	6" X 36" Lathe Pkg	6"		36"	AT116		AT715	\$1,680.00	<b>\$1,512.00</b>
64PKA038	6" X 40" Lathe Pkg	6"		40"	AT116		AT715	\$1,680.00	<b>\$1,512.00</b>
64PKA039	8" X 40" Lathe Pkg	8"		40"	AT116		AT715	\$1,680.00	<b>\$1,512.00</b>
64PKA040	8" X 44" Lathe Pkg	8"		44"	AT116		AT715	\$2,040.00	<b>\$1,836.00</b>
64PKA041	8" X 48" Lathe Pkg	8"		48"	AT116		AT715	\$2,040.00	<b>\$1,836.00</b>
64PKA042	10" X 40" Lathe Pkg	10"		40"	AT116		AT715	\$1,680.00	<b>\$1,512.00</b>
64PKA043	10" X 44" Lathe Pkg	10"		44"	AT116		AT715	\$2,040.00	<b>\$1,836.00</b>
64PKA044	10" X 48" Lathe Pkg	10"		48"	AT116		AT715	\$2,040.00	<b>\$1,836.00</b>
64PKA045	10" X 60" Lathe Pkg	10"		60"	AT116		AT715	\$2,040.00	<b>\$1,836.00</b>
64PKA046	12" X 40" Lathe Pkg	12"		40"	AT116		AT715	\$1,680.00	<b>\$1,512.00</b>
64PKA047	12" X 44" Lathe Pkg	12"		44"	AT116		AT715	\$2,040.00	<b>\$1,836.00</b>
64PKA048	12" X 48" Lathe Pkg	12"		48"	AT116		AT715	\$2,040.00	<b>\$1,836.00</b>
64PKA049	12" X 52" Lathe Pkg	12"		52"	AT116		AT715	\$2,040.00	<b>\$1,836.00</b>
64PKA050	12" X 60" Lathe Pkg	12"		60"	AT116		AT715	\$2,040.00	<b>\$1,836.00</b>
64PKA051	12" X 72" Lathe Pkg	12"		72"	AT116		AT715	\$2,040.00	<b>\$1,836.00</b>
64PKA052	14" X 40" Lathe Pkg	14"		40"	AT116		AT715	\$1,680.00	<b>\$1,512.00</b>
64PKA053	14" X 44" Lathe Pkg	14"		44"	AT116		AT715	\$2,040.00	<b>\$1,836.00</b>
64PKA054	14" X 48" Lathe Pkg	14"		48"	AT116		AT715	\$2,040.00	<b>\$1,836.00</b>
64PKA055	14" X 52" Lathe Pkg	14"		52"	AT116		AT715	\$2,040.00	<b>\$1,836.00</b>
64PKA056	14" X 60" Lathe Pkg	14"		60"	AT116		AT715	\$2,040.00	<b>\$1,836.00</b>
64PKA057	16" X 60" Lathe Pkg	16"		60"	AT116		AT715	\$2,040.00	<b>\$1,836.00</b>
64PKA026	6" X 12" Grinder Pkg		12"	6"		AT116	AT116	\$1,620.00	<b>\$1,458.00</b>
64PKA027	6" X 14" Grinder Pkg		14"	6"		AT116	AT116	\$1,620.00	<b>\$1,458.00</b>
64PKA028	8" X 12" Grinder Pkg		12"	8"		AT116	AT116	\$1,620.00	<b>\$1,458.00</b>
64PKA029	8" X 14" Grinder Pkg		14"	8"		AT116	AT116	\$1,620.00	<b>\$1,458.00</b>
64PKA030	8" X 16" Grinder Pkg		16"	8"		AT116	AT116	\$1,620.00	<b>\$1,458.00</b>
64PKA031	10" X 18" Grinder Pkg		18"	10"		AT116	AT116	\$1,620.00	<b>\$1,458.00</b>
64PKA032	10" X 24" Grinder Pkg		24"	10"		AT116	AT116	\$1,620.00	<b>\$1,458.00</b>
64PKA033	12" X 18" Grinder Pkg		18"	12"		AT116	AT116	\$1,620.00	<b>\$1,458.00</b>
64PKA034	12" X 20" Grinder Pkg		20"	12"		AT116	AT116	\$1,620.00	<b>\$1,458.00</b>

\*To receive your free Test Indicator and Stand log on to [www.mitutoyo.com](http://www.mitutoyo.com) and select About->Contacting MAC->Product Registration. Fill out and submit the form and a Test Indicator and Stand will be shipped to you.



# Profile Projectors

## PH-A14 Horizontal Profile Projector



### Features

- Mitutoyo's lens technology and workmanship combine to provide a bright, crisp image for error free inspection
- 8" x 4" floating-type workstage incorporates linear scales for fast, accurate measurement
- The workstage provides high accuracy and can handle a workload of up to 100 lbs.
- 10x objective lens and fiber illuminator are standard accessories

Order No.	Description	List Price	Sale Price
64PKA087	PH-A14 Profile Projector w/QM Data (Arm Mount)	\$8,290.00	<b>\$7,875.00</b>
64PKA086	PH-A14 Profile Projector w/KA counter & tray	\$6,380.00	<b>\$6,061.00</b>
64AAA129B	PHA14 Stand (optional)	\$707.00	<b>\$671.65</b>

## PV-5110 Profile Projector

### Features

- Large 500mm screen
- Floor model that uses a downward illumination system.
- Digital readout protractor screen (including zero-setting, ABS/INC coordinate switching functions) for easy and error-free angle measurement.
- Angled screen allows projected images to be easily traced or compared with a template.
- The oblique surface illumination system provides clear and bright images, allowing easy inspection of non-reflective workpieces such as plastic parts or printed materials.

### Standard Accessories

- 200x100mm (8" x 4") stage
- 10x projection lens set
- Surface illumination unit
- Counter stand for KA counter
- Power cord, halogen bulb, fuse, grounding wire, allen wrench, vinyl cover



**PV-5110**  
with optional KA counter

Order No.	Description	List Price	Sale Price
304-919A	Profile Projector PV-5110	\$24,200.00	<b>\$21,780.00</b>
264-156A	QM-Data200 (Arm-Mount Model)	\$2,720.00	<b>\$2,584.00</b>
332-151	Optoeye-200	\$1,650.00	<b>\$1,320.00</b>
12AAE672	Attachment (B) for Optoeye-200	\$58.65	<b>\$52.80</b>
174-173A	KA Counter	\$587.65	<b>\$528.30</b>



## PH-3515F Horizontal Profile Projector

### Features

- Heavy-Duty, bench-top model with horizontal optical system
- Erect image on Day-bright screen
- 14" (356mm) dia. protractor screen with crosshair line for easy alignment
- Floating-type workstage incorporates linear scales for fast, accurate measurement
- Suitable for thread pitch measurements – free from blurred or distorted images when the workpiece is angled



QM-Data 200  
**264-156A**  
Included in  
Package #  
64PKA088A

Stand  
(Not Shown)  
**64AAB176**  
(optional)

Order No.	Description	List Price	Package Price
<b>64PKA088A</b>	PH-3515F Profile Projector w/QM Data (Arm Mount)	\$13,500.00	<b>\$12,825.00</b>
<b>64PKA089A</b>	PH-3515F Profile Projector w/KA counter & tray	\$11,600.00	<b>\$11,020.00</b>
<b>64AAB176</b>	PH-3515 Stand (optional)	\$687.00	<b>\$652.65</b>

## PJ-A3000 Vertical Profile Projector



PJ-A3010F-200



### Features

- A series of midsize profile projectors featuring bright, 12.40" (315mm) diameter screens and easy-to-operate XY measurement tables.
- A floating table makes measuring quicker and easier.
- Easy-to-read digital counters are located near the projection screen, thereby minimizing strain associated with excessive movement.
- For edge sensing capabilities, order the Optoeye-200, part number 332-151

Order No.	Description	XY Range	List Price	Sale Price
<b>302-701A</b>	PJ-A3010F-200	8" x 4"	\$13,600.00	<b>\$12,240.00</b>
<b>302-703A</b>	PJ-A3010F-100	3.94" x 3.94"	\$10,800.00	<b>\$9,720.00</b>

### Optional Accessories

Order No.	Description	List Price	Sale Price
<b>264-156A</b>	QM-Data 200	\$2,720.00	<b>\$2,584.00</b>
<b>332-151</b>	Optoeye 200	\$1,650.00	<b>\$1,320.00</b>
<b>64PMI167</b>	Stand for PJ-A3000	\$688.00	<b>\$653.60</b>
<b>12AAA807</b>	RS-232C Cable	\$54.30	<b>\$51.60</b>
<b>12AAE671</b>	Attachment board (A)	\$40.80	<b>\$36.70</b>



### Vertical Profile Projectors

The main advantage of a vertical profile projector is the ability to place flexible parts such as gaskets directly on the stage glass allowing "gravity" to hold the part in place.

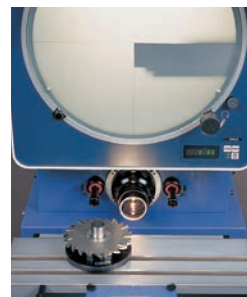

### Horizontal Profile Projectors

The chief advantage of a horizontal projector is the ability to measure larger/heavier parts than could be measured on a vertical comparator.

# Laser Scan Micrometers

## Bench Top Non-Contact Measuring System

### Features

- Integrated display and measuring unit into one unit
- Ideal for bench-top measurement in an inspection room
- Statistical calculation mode
- RS-232C interface, I/O interface, and SPC output interface are provided as standard
- Includes Quicktool\*, a free software package that makes operation of LSM setting simple and easy
- \*For use with customer supplied PC and RS-232C cable



Order No.	Description	Range	Resolution	List Price	Sale Price
544-116-1A	LSM-9506 Bench Top Laser Micrometer	.020" - 2.36"/0.5mm - 60mm	.000002" - .005"/0.00005 - 0.1mm	\$8,940.00	<b>\$8,046.00</b>

## High Accuracy Non-Contact Measuring Systems

### Features

- Excellent linearity: down to +/- 0.3 microns
- High speed scanning capable: 3200 scans per second
- Various ranges available for selecting the best laser for your application
- Statistical calculation mode
- Includes Quicktool\*, a free software package that makes operation of LSM setting simple and easy
- \*For use with customer supplied PC and RS-232C cable



**Package**

### LSM-6200 Display Unit Included!

It's memory function has been increased to allow storage of up to 100 programs and includes a built in program to measure odd fluted drills and endmills.

Order No	Model	Range Inch	Range mm	Repeatability	Linearity	Scanning Rate	List Price	Sale Price
64PKA117	LSM-500S	.0002" - .08"	0.005~2mm	±0.03µm	±0.3µm	3,200 scans/sec	\$10,370.00	<b>\$9,333.00</b>
64PKA118	LSM-501S	.002" - .4"	0.05~10mm	±0.04µm	±0.5µm	3,200 scans/sec	\$9,330.00	<b>\$8,397.00</b>
64PKA119	LSM-503S	.012" - 1.18"	0.3~30mm	±0.11µm	±1.0µm	3,200 scans/sec	\$10,110.00	<b>\$9,099.00</b>
64PKA120	LSM-506S	.04" - 2.36"	1~60mm	±0.36µm	±3µm	3,200 scans/sec	\$11,480.00	<b>\$10,332.00</b>
64PKA121	LSM-512S	.04" - 4.72"	1~120mm	±0.85µm	±6µm	3,200 scans/sec	\$17,680.00	<b>\$15,912.00</b>
64PKA122	LSM-516S	.04" - 6.30"	1~160mm	±1.4µm	±7µm	3,200 scans/sec	\$28,480.00	<b>\$25,632.00</b>

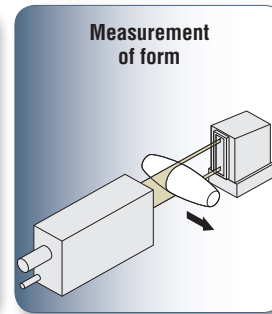
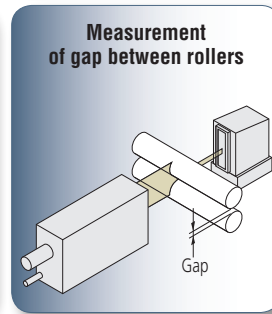
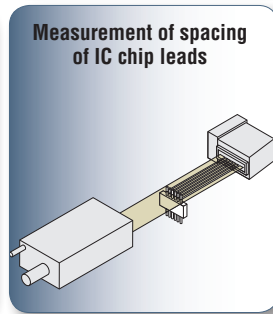
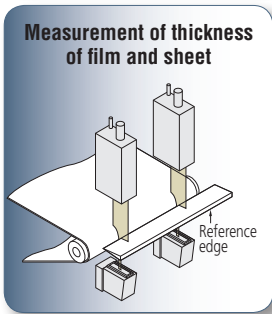
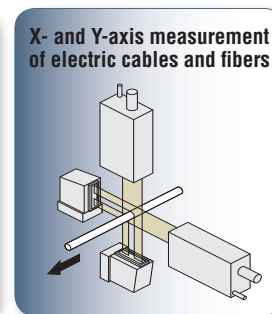
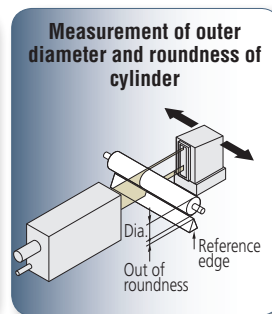
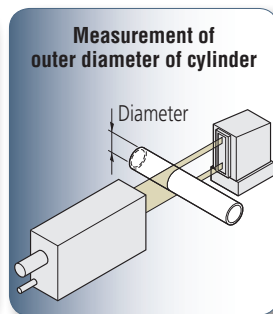
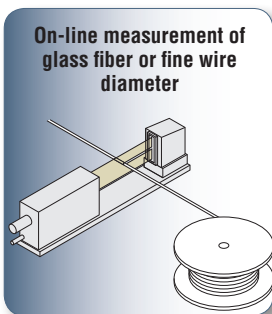



## Litematic and Litematic Head High-resolution Measuring Unit

### Features

- The Litematic is designed for measuring easily-deformed workpieces and high-precision parts such as pin gages, thin-wall bearings, plastic parts, and springs.
- Extra-low measuring force of 0.01N (1gf).
- Hands free operation with optional foot switch.
- Ceramic anvil is free from corrosion and easy to maintain.
- The Litematic Head unit can be mounted onto fixtures or an optional stand to allow great flexibility of use.
- With SPC output.

Order No.	Resolution	Range	Accuracy (at 20°C)	List Price	Sale Price
318-221A	.5µinch, 5µinch, 50µinch, 0.01µm,	0 - 2" (50mm)	(0.5 + L / 100)µm L=Measured length (mm)	\$8,480.00	<b>\$7,208.00</b>
318-226A	0.1µm, 1µm	0 - 2" (50mm)	(0.5+L/100)µm L=Measured length (mm)	\$8,490.00	<b>\$7,208.00</b>
957460	Dedicated Stand for Model 318-226A*			\$4,370.00	<b>\$3,714.00</b>



318-221A



318-226A

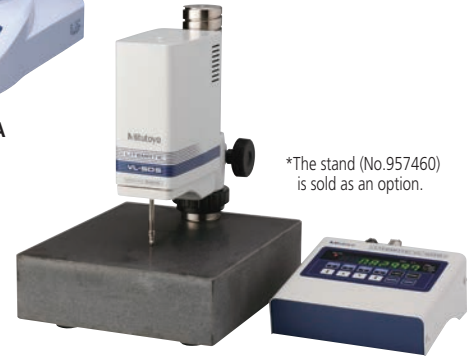

\*The stand (No.957460) is sold as an option.

### Film and sheet

If the workpiece flexes, making accurate measurement impossible, using a type with a larger measuring force or adding a weight to the spindle may be effective.

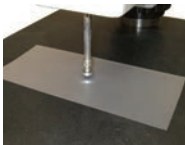

- ▶ Film
- ▶ Flexible substrates
- ▶ Various types of sheet



### Precision components

The Litematic can be used as a high-precision displacement gage.



- ▶ Bearing
- ▶ Shaft



### Thin sheet metal

Because the measuring force is small, deformation of the workpiece can be minimized.



- ▶ Chassis
- ▶ Shimming materials
- ▶ Blade springs
- ▶ Beverage can materials

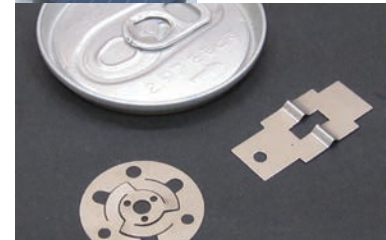

### Rubber and plastic

If the workpiece is soft the risk of indentation may be reduced by replacing the standard contact point with one of larger radius, such as an optional carbide-ball type.

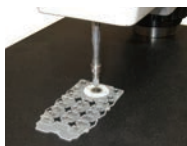

- ▶ Plastic
- ▶ Rubber
- ▶ Keypad



### Electronic components

For this type of workpiece the smallest measuring force available is recommended.

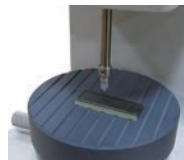

- ▶ Printed circuit boards
- ▶ Connectors
- ▶ Battery components

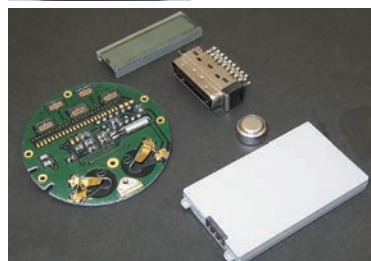

### Medical and pharmaceutical products

If the workpiece is soft the risk of indentation may be reduced by replacing the standard contact point with one of larger radius, such as an optional carbide-ball type.

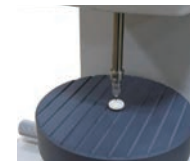

- ▶ Injection needles
- ▶ Pills
- ▶ Patches and ointments



# Hardness Testers

## Rockwell Hardness Tester

### With Real-Time Electronic Test Force Control



**HR-521**  
**810-202-03A**

#### Features

- Closed-loop control of testing forces
- Primary and final forces (loads) are applied with unparalleled accuracy and repeatability
- Extended indenter arm reaches inside diameters and hard to reach surfaces at eye level, allowing the operator to easily see where the indenter addresses small or hard to reach parts
- Automatic setting of preliminary test force and application of total test force
- Indenter escape function allows automatic removal of preliminary test force at end of test cycle
- Touch screen operation with a back-lit LCD graphic display
- Hardness scale is set automatically via the touch screen
- Cylindrical and spherical surface compensation
- Auto conversion to all hardness scales or tensile strength

Order No.	810-202-03A	
Preliminary Test Force	29.42N (3kgf), 98.07N (10kgf)	
Test Force	Rockwell	588.4N (60kgf), 980.7N (100kgf), 1471N (150kgf)
	Rockwell Superficial	147.1N (15kgf), 294.2N (30kgf), 441.3N (45kgf)
	Brinell	1839N (187.5kgf) (for use with 2.5mm ball)
Force Control	Automatic control (unloading/duration/unloading) with closed loop feed back	
Console/Display Unit	Touch screen operation with back-lit LCD graphic display	
Test Force Selection	By touch screen	
Table up/down drive	Manual (w/Auto-brake mechanism)	
Load Duration	0 to 120 sec. (1 sec. step)	
Maximum Specimen Height	8.1" (205mm)	
Maximum Specimen Depth	5.9" (150mm)	
Display Indication Functions	Hardness value, Converted hardness value, Test conditions, OK/NG tolerance judgement, statistical processing result, Rockwell/Rockwell superficial hardness testing, Continuous testing, Cylindrical/spherical surface compensation, data offset, Hardness conversion (HV, HK, HRA/B/C/D/F, G/15T/30T/45T/15N/30N/45N, HS, HB, HBW, tensile strength) OK/NG tolerance judgement, measured data editing, data memory (max 1024 data), SPC calculation (No. of data, max/min/mean values, range, upper/lower limit values, standard deviation, No. of passing/defective), Histogram, x-R chart	
Data Output	RS-232C, SPC, Centronics	
Dimensions (W x D x H)	9.84" x 26.38" x 23.82" (250 x 670 x 605mm)	
Mass	60kg	

Order No.	Description	List Price	Sale Price
810-202-03A	Rockwell Hardness Tester	\$15,000.00	<b>\$13,950.00</b>

## Rockwell Hardness Testers



- Model: **HR-210MR**
- Rockwell
  - Motorized test force control
  - Test force selection manual by weight



- Model: **HR-320MS**
- Rockwell/Rockwell Superficial
  - Motorized test force control
  - Test force selection manual by weight



- Model: **HR-430MR**
- Rockwell
  - Motorized test force control
  - Dial a weight test force selection
  - Auto brake/start



- Model: **HR-430MS**
- Rockwell/Rockwell Superficial
  - Motorized test force control
  - Dial a weight test force selection
  - Auto brake/start

Model Order No.	HR-210MR 963-220-10A	HR-320MS 963-231-10A	HR-430-MR 963-240-10A	HR-430MS 963-241-10A
Rockwell	+	+	+	+
Rockwell Superficial	—	+	—	+
Light Force Brinell	Optional	Optional	Optional	Optional
Display Unit	Analog	Digital: Hardness value, Scale display, Timer setting, Conversion, GO/NG judgment, Offset setting		
Data Output	—	RS-232C SPC (Digimatic)		
Dial a Weight	—	—	+	+
Motorized Test Force Control	+	+	+	+
Automatic Brake/Start	—	—	+	+
List Price	\$6,100.00	\$8,740.00	\$9,000.00	\$10,000.00
<b>Sale Price</b>	<b>\$4,990.00</b>	<b>\$6,990.00</b>	<b>\$7,990.00</b>	<b>\$8,990.00</b>

### Mitutoyo is proud to introduce the new 963 Series of Hardness Testers.

Four new features packed yet economical Rockwell and Rockwell Superficial Hardness Testers cover a large range of testing applications. These testers meet the current international requirements such as ASTM E18 and are designed for years of accurate results.

## Impact Type Portable Hardness Tester

Rebound type portable hardness tester featuring reproducibility and ease of operation on large parts. It is light weight and can be conveniently carried into the shop or out in the field.



Order No.	Type	List Price	Sale Price
<b>810-298</b>	HH-411 Hardmatic	\$4,980.00	<b>\$4,482.00</b>

Model	HH-411		
Order No.	<b>810-298</b>		
Hardness Range	L-Value (ASTM A956)		
Detector	Input device D (carbide ball)		
Display	<b>Hardness</b>	<b>Range</b>	<b>Resolution</b>
	HL	1-999 HL	1 HL
	HV	43-950 HV	1 HV
	HB	20-894 HB	1 HB
	HRC	19.3-68.2 HRC	0.1 HRC
	HRB	13.5 - 101.7 HRB	0.1 HRB
	HS	13.2 - 99.3 HS	0.1 HS
	HTN	499 - 1996 Mpa	1 Mpa
Functions	Conversions: HL, HV, HB, HRC, HRB, HS, HTN Judgment: OK/NG Offsetting Memory: 1,800 data		
Output	RS-232C, SPC		
Power supply	Alkaline AA Battery 2pcs.		
Dimensions	Detector: (Dia. X H) 1.10" x 6.89" (28 x 175mm)		
	Display: (W x D x H) 2.76" x 4.33" x 1.38" (70 x 110 x 35mm)		
Mass	Detector: .26lbs (20g)		
	Display: .44lbs (200g)		

## Stereo Microscopes with Continuous 1X - 4X Magnification

Traditional binocular/trinocular stereo microscopes for industrial, medical, and classroom applications. It is ideal for electrical small part inspection, assembly, and medical/biological dissection.

### Features

- Continuous 1X - 4X magnification
- The image is always in focus throughout zoom range
- Crisp, erect images with high resolution and excellent stereoscopic effect
- Stereo-tube can be rotated a full 360°, for viewing at any angle
- Bilateral zoom control knob adds convenience and increases operator efficiency
- Diopter adjustment for both eyepieces
- Binocular Tube Inclination: 45°
- Focusing Range: 1.46" (37mm)
- Interpupillary Adjustable Range: 2.12" - 2.99" (54mm - 76mm)



Order No.	Description	List Price	Sale Price
<b>377-972A</b>	Binocular Stereo Microscope	\$1,150.00	<b>\$1,092.00</b>

## Toolmaker's Microscope



The TM-505D/510D is a compact microscope well suited for measuring dimensions and angles of machined metals. It can also be used to check the shape of screws and gears by attaching an optional reticle. Its compact body makes it ideal for use on shop-floors with limited space!

- The eyepiece section of the optical tube incorporates a vernier protractor. Angle measurement is performed easily by turning the protractor to align the cross-hair reticle with the workpiece image.
- Complete selection of interchangeable reticles are available.
- Both the transmitted and reflected illumination intensity can be adjusted to obtain the optimal illumination intensity for the workpiece.
- Two XY stages with different travel ranges, 2" x 2" (50mm x 50mm) and 4" x 2" (100mm x 50mm), are available.

Order No.	Description	List Price	Sale Price
<b>176-808A</b>	TM-505 With Mic Heads, 2 X 2" Stage	\$5,490.00	<b>\$4,941.00</b>
<b>176-809A</b>	TM-510 With Mic Heads, 4 X 2" Stage	\$7,320.00	<b>\$6,588.00</b>
<b>937387</b>	40" Mic Head Cable	\$50.85	<b>\$48.30</b>
<b>965013</b>	80" Mic Head Cable	\$60.10	<b>\$57.10</b>
<b>64AAB214</b>	LED Variable Ring Light	\$190.00	<b>\$180.50</b>



# Mitutoyo

## GO FOR GOLD!



### Gold Care is Back Based on Customer Demand

Your ultra-precise part inspection process demands the best. But the cost of ownership issues drives a strong bottom line focus as well. Our Gold Care Program lets you achieve both. Simply it's the packaging of our industry leading Coordinate Measuring Machines and Vision Measuring Systems paired with productivity enhancing products and services. Packages are valued at up to \$20,000 and bundled at our base machine price. To learn more visit [MITUTOYO.COM/GETGOLD](http://MITUTOYO.COM/GETGOLD) or call 888-MITUTOYO.

#### Included in the Gold Care Program:

- A "Second Year" Extended Warranty
- A Five-year Extended Warranty for Manual CMM's
- Two-year "Bronze" Calibration Agreement\*
- Five-year Software Technical Phone Support
- One seat at Mitutoyo Institute of Metrology Class
- MeasurLink® Pro Edition Quality Data Management Software\*
- MITUTOYO Eco-Fix® or Opti-Fix® Starter Fixture Kit
- MITUTOYO Starter Stylus Kit (Included with Touch Probe Machines)
- MITUTOYO Fixture Builder Software\*\*

Qualifying machines include CRYSTA APEX S 500/700/900/1200, CRYSTA-PLUS MANUAL 500/700, QV-APEX 302/404/606 and QV-APEX 302TP/404TP/606TP

\* Not included with the CRYSTA-PLUS MANUAL 500/700

\*\* CRYSTA-APEX S 500/700/900/1200

View Video of  
Gold Care Program



[www.mitutoyo.com/gold](http://www.mitutoyo.com/gold)

Visit us at booth E-5214

Mitutoyo America Corporation | 1-888-mitutoyo | [www.mitutoyo.com](http://www.mitutoyo.com)

CMM • VISION • FORM AND FINISH • PRECISION TOOLS AND INSTRUMENTS • DATA MANAGEMENT

Coordinate Measuring Machines	=====
Vision Measuring Systems	=====
Form Measurement	=====
Optical Measuring	=====
Sensor Systems	=====
Testing Equipment and Seismometer	=====
Digital Scale and DRO Systems	=====
Small Tool Instruments and Data Management	=====

Distributed By:

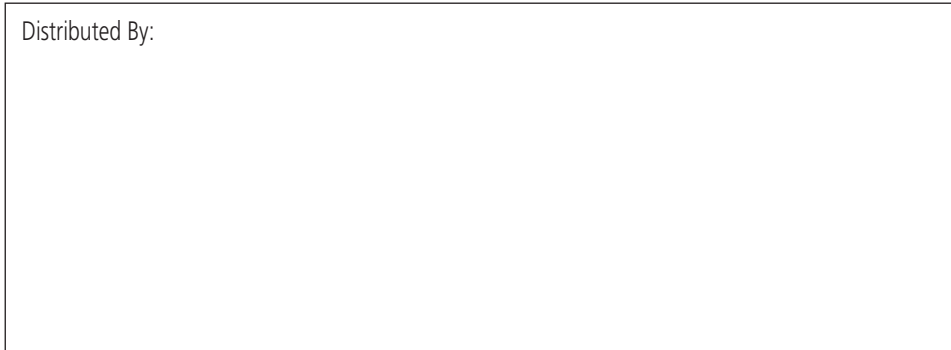

Note: All information regarding our products, and in particular the illustrations, drawings, dimensional and performance data contained in this printed matter as well as other technical data are to be regarded as approximate average values. We therefore reserve the right to make changes to the corresponding designs. The stated standards, similar technical regulations, descriptions and illustrations of the products were valid at the time of printing. In addition, the latest applicable version of our General Trading Conditions will apply. Only quotations submitted by ourselves may be regarded as definitive. Mitutoyo products are subject to US Export Administration Regulations (EAR). Re-export or relocation of Mitutoyo products may require prior approval by an appropriate governing authority.

#### Trademarks and Registrations

Designations used by companies to distinguish their products are often claimed as trademarks. In all instances where Mitutoyo America Corporation is aware of a claim, the product names appear in initial capital or all capital letters. The appropriate companies should be contacted for more complete trademark and registration information.

**Mitutoyo America Corporation**  
[www.mitutoyo.com](http://www.mitutoyo.com)

One Number to Serve You Better  
**1-888-MITUTOYO (1-888-648-8869)**

#### M<sup>3</sup> Solution Centers

Aurora, Illinois

(Corporate Headquarters)

Westford, Massachusetts

Huntersville, North Carolina

Mason, Ohio

Plymouth, Michigan

City of Industry, California

Birmingham, Alabama

Renton, Washington

Houston, Texas

# Mitutoyo

Precision is our Profession