

Mitutoyo



FALL PROMO 2016 PRECISION TOOLS & INSTRUMENTS

Effective September 6 through December 16, 2016

FALL PROMO 2016

COOLANT PROOF™ IP67



Mitutoyo Quality

Bulletin No. 2225



Dear Valued Customers,

We wanted to take this opportunity to personally thank the companies and individuals who partner with us for their continued support and commitment.

The Fall Promotion is our second large-scale Precision Tools & Instruments Promotion of 2016 and will be effective from September 6 through December 16, 2016.

Please check our website at www.mitutoyo.com to watch for other new products, promotions and events during 2016.

Sincerely,

Shigeyuki Sasaki
President, Mitutoyo America Corporation



COOLANT PROOF™ IP65

COOLANT PROOF is the universal term of Mitutoyo Digimatic Small Tool Instruments that are free from measurement error and physical deterioration due to routine exposure to water, cutting oil or coolant. This high performance is achieved by using encoders that are inherently immune to contamination, where exposure is inevitable, combined with comprehensive sealing techniques and extremely oil-resistant materials to guarantee a long working life under normal operating conditions.

QuantuMike Micrometer

4X Faster Spindle Travel

- > Faster measurement with 2mm travel per revolution instead of the standard 0.5mm.
- > A patented ratchet thimble mechanism helps ensure repeatability.
- > A Function lock helps prevent error.
- > IP65 rated
- > Certificate of inspection provided.



COOLANT PROOF™



Significant reduction in positioning time

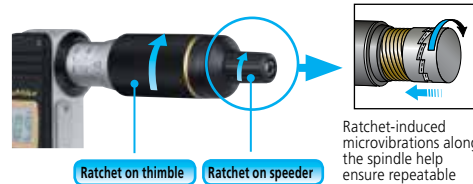
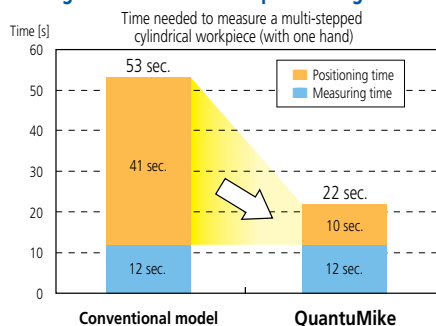

Ratchet-induced microvibrations along the spindle help ensure repeatable measurements.

Order No.	Range	Resolution	List	Promo
293-180*	0-1"/0-25mm	.00005"/0.001mm	\$262.00	\$248.90
293-181*	1-2"/25-50mm	.00005"/0.001mm	\$300.00	\$285.00
293-185	0-1"/0-25mm	.00005"/0.001mm	\$226.00	\$214.70
293-186	1-2"/25-50mm	.00005"/0.001mm	\$258.00	\$245.10
293-182-30*	2-3"/50.8 - 76.2mm	.00005"/0.001mm	\$358.00	\$340.10
293-187	2-3"/50.8 - 76.2mm	.00005"/0.001mm	\$310.00	\$294.50
293-183*	3-4"/76.2 - 101.6mm	.00005"/0.001mm	\$385.00	\$365.75
293-188	3-4"/76.2 - 101.6mm	.00005"/0.001mm	\$372.00	\$353.40

*with SPC Output

Order No.	Description	List	Promo
05CZA662	40" SPC Cable	\$83.80	\$79.60
05CZA663	80" SPC Cable	\$92.45	\$87.85



www.mitutoyo.com/qm4x
VIDEO DEMO

IMTS2016
September 12-17, 2016 | McCormick Place, Chicago
VISIT US AT BOOTH **E-5215**

MDC Micrometer

- > New electromagnetic ABSOLUTE sensor - Improved resistance to environmental conditions such as dirt, oil and water, which can cause false readings.
- > New ratchet thimble models improve one-hand operability.
- > New anti-slip finish for improved grip while taking measurements.
- > Long battery life – 2.4 years under normal operation.
- > Fully compatible with existing Mitutoyo Digimatic peripherals (SPC Cables, U-Wave wireless transmitters, DP1-VR, etc.) – SPC output-enabled IP65 models.
- > Function-lock system prevents inadvertent setting changes.
- > Certificate of inspection provided.



COOLANT PROOF™

Order No.	Range	Resolution	Remarks	List	Promo
IP65 - With SPC Output					
293-330-30	0-1"/0-25.4mm	.00005"/0.001mm	Ratchet Stop	\$240.00	\$228.00
293-331-30	1-2"/25.4-50.8mm	.00005"/0.001mm	Ratchet Stop w/Standard	\$283.00	\$268.85
IP65 - Non-SPC Output					
293-340-30	0-1"/0-25.4mm	.00005"/0.001mm	Ratchet Stop	\$187.00	\$177.65
293-344-30	0-1"/0-25.4mm	.00005"/0.001mm	Ratchet Thimble	\$187.00	\$177.65
293-348-30	0-1"/0-25.4mm	.00005"/0.001mm	Friction Thimble	\$187.00	\$177.65
293-349-30	0-1"/0-25.4mm	.0001"/0.001mm	Ratchet Thimble	\$187.00	\$177.65
293-341-30	1-2"/25.4-50.8mm	.00005"/0.001mm	Ratchet Stop w/Standard	\$243.00	\$230.85
293-345-30	1-2"/25.4-50.8mm	.00005"/0.001mm	Ratchet Thimble w/Standard	\$243.00	\$230.85

Order No.	Description	List	Promo
05CZA662	40" SPC Cable	\$83.80	\$79.60
05CZA663	80" SPC Cable	\$92.45	\$87.85



MDH Micrometer

High-Accuracy Sub-Micron Digimatic Micrometer

- > Enabling .000005" / 0.1µm resolution measurement, this micrometer is ideal for customers who need to make highly accurate measurements with a handheld tool.
- > The ABS (absolute) rotary sensor eliminates the need to perform origin setting each time the power is turned on, allowing you start measuring right away. With no possibility of overspeed errors, the High-Accuracy Digimatic Micrometer delivers a higher level of reliability.
- > Certificate of inspection provided.



Order No.	Range	Resolution	Accuracy	List	Promo
293-100	0 - 25mm	0.0001mm/ 0.0005mm (switchable)	±0.5µm	\$1,630.00	\$1,548.50
293-130	0 - 1" / 0 - 25.4mm	.000005"/.00002" 0.0001mm/0.0005mm (switchable)	±.00002"	\$1,630.00	\$1,548.50

Order No.	Description	List	Promo
05CZA662	40" SPC Cable	\$83.80	\$79.60
05CZA663	80" SPC Cable	\$92.45	\$87.85

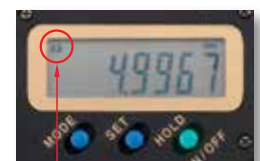

Spline Micrometer

- >The anvil and spindle have a small diameter for measuring splined shafts, slots and keyways.
- >With SPC output
- >With a standard bar except 0-1"
- >Resolution: .00005"/0.001mm



Digital

Order No.	Range	Accuracy	Contacts	List	Promo
331-351-30	0 - 1" / 0 - 25.4mm	±.0001"	Ø.118"	\$470.00	\$446.50
331-361-30		±.0001"	Ø.079"	\$470.00	\$446.50
331-352-30	1 - 2" / 25.4-50.8mm	±.0001"	Ø.118"	\$527.00	\$500.65
331-362-30		±.0001"	Ø.079"	\$527.00	\$500.65
331-353-30	2 - 3" / 50.8-76.2mm	±.0001"	Ø.118"	\$571.00	\$542.45
331-363-30		±.0001"	Ø.079"	\$549.00	\$521.55
331-354-30	3 - 4" / 76.2-101.6mm	±.00015"	Ø.118"	\$661.00	\$627.95
331-364-30		±.00015"	Ø.079"	\$577.00	\$548.15

SPC cable with data switch – 1m: 05CZA662 2m: 05CZA663

Spherical Face Micrometer

- >Designed to measure the wall thickness of various tubing.
- >Resolution: .00005"/0.001mm
- >With SPC output.
- >With a standard bar except 0-1" model.
- >With digit counter.



Digital model with spherical anvil

Order No.	Range	Accuracy	Min ID	List	Promo
395-371-30 ^S	0 - 1" / 0 - 25.4mm	±.0001"	D: .59"	\$410.00	\$389.50
395-372-30 ^S	1" - 2" / 25.4 - 50.8mm	±.0001"	D: .59"	\$435.00	\$413.25
395-373-30 ^S	2" - 3" / 50.8-76.2mm	±.0001"	D: .75"	\$494.00	\$469.30
395-374-30 ^S	3" - 4" / 76.2-101.6mm	±.00015"	D: .79"	\$527.00	\$500.65
395-351-30 ^F	0 - 1" / 0 - 25.4mm	±.0001"	D: .59"	\$397.00	\$377.15
395-352-30 ^F	1" - 2" / 25.4 - 50.8mm	±.0001"	D: .59"	\$425.00	\$403.75
395-353-30 ^F	2" - 3" / 50.8-76.2mm	±.0001"	D: .75"	\$482.00	\$457.90
395-354-30 ^F	3" - 4" / 76.2-101.6mm	±.00015"	D: .79"	\$516.00	\$490.20

SPC cable with data switch – 1m: 05CZA662 2m: 05CZA663

Point Micrometer

- >Pointed spindle and anvil for measuring the web thickness of drills, small grooves, keyways and other hard-to-reach dimensions.
- >The measuring points have approximately 0.3mm / .012" radius.
- >With a standard bar except 0 - 1"
- >Resolution: 00005" / 0.001mm (digital models)
- >With SPC output.
- >With carbide tips unless otherwise noted.



Digital

Order No.	Range	Accuracy	Point	List	Promo
342-351-30	0 - 1" / 0 - 25.4mm	±.0001"	15°	\$462.00	\$438.90
342-361-30		±.0001"	30°	\$462.00	\$438.90
342-352-30	1" - 2" / 25.4 - 50.8mm	±.0001"	15°	\$515.00	\$489.25
342-362-30		±.0001"	30°	\$504.00	\$478.80
342-353-30	2" - 3" / 50.8 - 76.2mm	±.0001"	15°	\$537.00	\$510.15
342-363-30		±.0001"	30°	\$537.00	\$510.15
342-354-30	3" - 4" / 76.2 - 101.6mm	±.00015"	15°	\$571.00	\$542.45
342-364-30		±.00015"	30°	\$571.00	\$542.45

SPC cable with data switch – 1m: 05CZA662 2m: 05CZA663

Tube Micrometer

- >Used to measure the wall thickness on tubing, pipe and other hard-to-reach places. Spherical or cylindrical anvils are available.
- >IP65 water/dust protection
- >With SPC output.



Anvil Type C



Digital

Order No.	Range	Resolution	Accuracy	Type	List	Promo
395-362-30	0 - 1" / 0 - 25.4mm	.00005" / 0.001mm	±.00015"	B	\$438.00	\$416.10
395-363-30				C	\$451.00	\$428.45
395-364-30				D	\$451.00	\$428.45

SPC cable with data switch – 1m: 05CZA662 2m: 05CZA663

Uni-Mike

- > Measures tubing thickness, shoulder-edge distance, rivet head height, etc. with interchangeable anvils (flat anvil, rod anvil, V-anvil).
- > IP65 water/dust protection.
- > Supplied with Flat Anvil (201216) and Rod Anvil: .118"/ø3mm dia. rod anvil (201217) for 0-1" models, .197"/ø5mm (201379) for 1-2"
- > With special optional disk anvils, the Uni-Mike can be used as a height micrometer.
- > With a standard bar except 0 -1" model.



Digital

Order No.	Range	Resolution	Accuracy	List	Promo
317-351-30	0 - 1" / 0 - 25.4mm	.00005" / 0.001mm	±.0002"	\$529.00	\$502.55
317-352-30	1 - 2" / 25.4 - 50.8mm	.00005" / 0.001mm	±.0002"	\$538.00	\$511.10

SPC cable with data switch – 1m: **05CZA662** 2m: **05CZA663**

QuickMike

- > Non-rotating spindle and the new ratchet friction thimble.
- > Speedy spindle feed: .4"/rev.
- > With absolute linear scale.
- > IP54 dust/water protection (when not connected with data output cable).
- > With SPC data output.
- > With a standard bar to set the origin point (for models with a range over 1.2").



Order No.	Range	Resolution	Accuracy	List	Promo
293-676	0 - 1.2" / 0 - 30.48mm	.00005" / 0.001mm	±.0001"	\$593.00	\$563.35
293-677	1" - 2.2" / 25.4 - 55.88mm	.00005" / 0.001mm	±.0001"	\$648.00	\$615.60
293-678	2" - 3.2" / 50.8 - 81.28mm	.00005" / 0.001mm	±.00015"	\$705.00	\$669.75
293-679	3" - 4.2" / 76.2 - 106.68mm	.00005" / 0.001mm	±.00015"	\$769.00	\$730.55

SPC cable – 1m: **937387** 2m: **965013**

Low Force/Adjustable Force Micrometer

- > Constant and low measuring force mechanism in the thimble.
- > Adjustable measuring force* accommodates various types of work materials. (*0.5-2.5N or 2-10N)
- > The measurement-value hold function automatically retains the data at a specified measuring force, ensuring accuracy.
- > Non-rotating spindle and the new ratchet friction thimble.
- > Speedy spindle feed: by .4"/rev.
- > With a standard bar to set the origin point (except for 0-.6", and 0-.4" models).
- > Resolution: .00005"/0.001mm Accuracy: ±.0001"



Order No.	Range	Measuring Force	List	Promo
227-211	0-.6"	0.5-2.5 (0.5, 1.0, 1.5, 2, 2.5) N	\$855.00	\$812.25
227-213	.6-1.2"	0.5-2.5 (0.5, 1.0, 1.5, 2, 2.5) N	\$901.00	\$855.95
227-215	0-.4"	2-10 (2, 4, 6, 8, 10) N	\$811.00	\$770.45
227-216	.4-.8"	2-10 (2, 4, 6, 8, 10) N	\$847.00	\$804.65
227-217	.8-1.2"	2-10 (2, 4, 6, 8, 10) N	\$874.00	\$830.30

SPC cable – 1m: **937387** 2m: **965013**

SPC Connecting Cables (optional)

Order No.	Description	List	Promo
With Data Out Switch			
05CZA662	1m — IP65 Micrometers	\$83.80	\$75.50
05CZA663	2m — IP65 Micrometers	\$92.45	\$83.50
959149	1m - Non IP Calipers, Large Micrometers	\$49.25	\$46.80
959150	1m - Non IP Calipers, Large Micrometers	\$55.20	\$52.45
Without Data Out Switch			
937387	1m - QuickMike models	\$50.85	\$48.30
965013	2m - QuickMike models	\$60.10	\$57.10



05CZA662: 1m (40")
05CZA663: 2m (80")



959149: 1m (40")
959150: 2m (80")



937387: 1m (40")
965013: 2m (80")

Watch our videos on Specialty Calipers & Micrometers on our YouTube channel:
<http://www.mitutoyo.com/ytplaylist>



Outside Micrometer with Interchangeable Anvils

- >Wide measuring range with interchangeable anvils.
- >Supplied with zero-setting standards bar for each range.



Order No.	Range	Resolution	List	Promo
340-351-30	0-6" / 0-152.4mm	.00005" / 0.001mm	\$732.00	\$695.40
340-352-30	6-12" / 152.4 - 304.8mm	.0001" / 0.001mm	\$900.00	\$855.00
340-720*	12-18" / 304.8 - 457.2mm	.0001" / 0.001mm	\$1,130.00	\$1,073.50
340-721*	18-24" / 457.2 - 609.6mm	.0001" / 0.001mm	\$1,280.00	\$1,216.00
340-722*	24-30" / 609.6 - 762.0mm	.0001" / 0.001mm	\$1,420.00	\$1,349.00
340-723*	30-36" / 762.0 - 914.4mm	.0001" / 0.001mm	\$1,500.00	\$1,425.00

SPC cable with data switch – 1m: **05CZA662** 2m: **05CZA663**
 * 1m: **959149** 2m: **959150**

Digimatic Micrometer

- >Wide range micrometers have an oversize frame and multiple anvils to allow a single micrometer to be used over a 6" range. This reduces tool cost for infrequently measured ranges.



Order No.	Range	Resolution	Accuracy	List	Promo
293-782	12" - 13" / 304.8 - 330.2mm	.0001" / 0.001mm	±.0003"	\$794.00	\$754.30
293-783	13" - 14" / 330.2 - 355.6mm	.0001" / 0.001mm	±.0003"	\$813.00	\$772.35
293-784	14" - 15" / 355.6 - 381.0mm	.0001" / 0.001mm	±.0003"	\$828.00	\$786.60
293-785	15" - 16" / 381.0 - 406.4mm	.0001" / 0.001mm	±.00035"	\$837.00	\$795.15
293-786	16" - 17" / 406.4 - 431.8mm	.0001" / 0.001mm	±.00035"	\$850.00	\$807.50
293-787	17" - 18" / 431.8 - 457.2mm	.0001" / 0.001mm	±.00035"	\$870.00	\$826.50
293-788	18" - 19" / 457.2 - 482.6mm	.0001" / 0.001mm	±.0004"	\$883.00	\$838.85

SPC cable with data switch – 1m: **959149** 2m: **959150**

Outside Micrometer with Extension Anvil Collars

- >2" spindle stroke.
- >Supplied with setting standards bar for each range.
- >Square and round pipes are combined for lightweight and rigid frame workpiece stopper.
- >Graduations: .001"

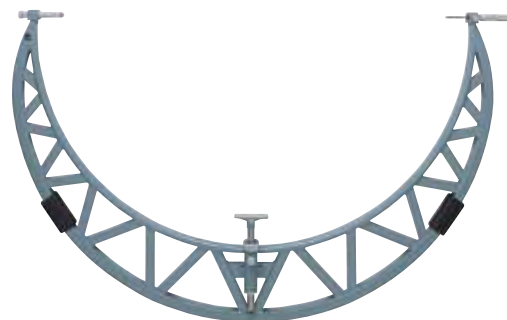

Mechanical

Order No.	Range	Extension collars	Mass (kg)	List	Promo
105-428	40 - 44"	2"	10	\$2,820.00	\$2,679.00
105-429	44 - 48"	2"	10.9	\$3,020.00	\$2,869.00
105-430	48 - 52"	2"	11.4	\$3,250.00	\$3,087.50
105-431	52 - 56"	2"	11.9	\$3,560.00	\$3,382.00
105-432	56 - 60"	2"	12.6	\$3,870.00	\$3,676.50
105-433	60 - 64"	2"	13.2	\$4,270.00	\$4,056.50
105-434	64 - 68"	2"	14.1	\$4,650.00	\$4,417.50
105-435	68 - 72"	2"	14.9	\$4,960.00	\$4,712.00
105-436	72 - 76"	2"	15.8	\$5,150.00	\$4,892.50
105-437	76 - 80"	2"	16.7	\$5,500.00	\$5,225.00

SPC Connecting Cables (optional)

Order No.	Description	List	Promo
With Data Out Switch			
05CZA662	1m — IP65 Micrometers	\$83.80	\$79.60
05CZA663	2m — IP65 Micrometers	\$92.45	\$87.85
959149	1m - Non IP Calipers, Large Micrometers	\$49.25	\$46.80
959150	1m - Non IP Calipers, Large Micrometers	\$55.20	\$52.45



05CZA662: 1m (40")
05CZA663: 2m (80")



959149: 1m (40")
959150: 2m (80")



IMTS2016

September 12-17, 2016 | McCormick Place, Chicago

VISIT US AT BOOTH **E-5215**



COOLANT PROOF™ IP67

COOLANT PROOF is the universal term of Mitutoyo Digimatic Small Tool Instruments that are free from measurement error and physical deterioration due to routine exposure to water, cutting oil or coolant. This high performance is achieved by using encoders that are inherently immune to contamination, where exposure is inevitable, combined with comprehensive sealing techniques and extremely oil-resistant materials to guarantee a long working life under normal operating conditions.

ABSOLUTE Coolant-Proof Calipers

- Sealed housing is IP-67 rated, meaning it's immune to the coolants, dirt, grit and chips found in many manufacturing environments.
- Easy to use - no need to wipe or clean the scale.
- .0005"/0.01mm resolution with ±.001" accuracy.
- Automatic power-on/off.
- Data output function.
- Certificate of inspection provided.



COOLANT PROOF™

Built-in ABS (absolute) scale means that these calipers are ready to use immediately after power-on without origin resetting. It's as easy as vernier caliper measurements.

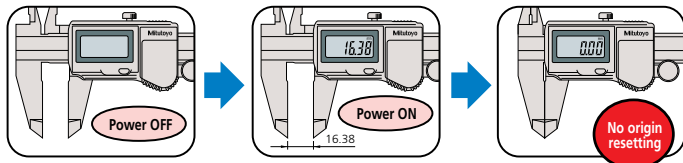

Order No.	Range	List	Promo
Non-Output Style			
500-752-20	0-6"/0-150mm	\$209.00	\$198.55
500-753-20	0-8"/0-200mm	\$280.00	\$266.00
500-754-10*	0-12"/0-300mm	\$484.00	\$459.80
SPC Output Style			
500-762-20	0-6"/0-150mm	\$248.00	\$235.60
500-763-20	0-8"/0-200mm	\$312.00	\$296.40
500-764-10*	0-12"/0-300mm	\$537.00	\$510.15

* ±.0015" accuracy

Order No.	Description	List	Promo
05CZA624	40" SPC Cable	\$93.90	\$89.20
05CZA625	80" SPC Cable	\$95.35	\$90.60



Super Caliper-Solar Powered, Coolant Proof

- World's most unique solar-powered super caliper is eco-friendly with no battery and has IP67 protection.
- Origin restoration unnecessary--a measurement can be started any time and with unlimited response speed.
- No battery or origin reset needed for IP67 Digital Caliper.
- The impact resistance of the display unit has been increased for improved usability in workshop conditions.
- This Super Caliper uses components that do not contain harmful substances and is compatible with RoHS Directives.

COOLANT PROOF™

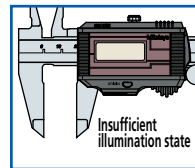

Improvement in surface finish of beam

Conventional

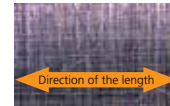

Ra: 0.126µm

Super Caliper

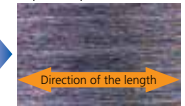

Ra: 0.07µm

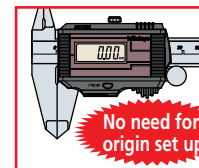
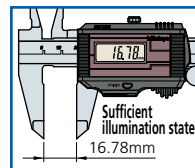

Order No.	Range	Accuracy	Resolution	List	Promo
500-786	0 - 6" / 0 - 150mm	±.001"	.0005"/0.01mm	\$267.00	\$253.65
500-784*	0 - 6" / 0 - 150mm	±.001"	.0005" / 0.01mm	\$239.00	\$227.05
500-787	0 - 8" / 0 - 200mm	±.001"	.0005"/0.01mm	\$330.00	\$313.50
500-785*	0 - 8" / 0 - 200mm	±.001"	.0005"/0.01mm	\$306.00	\$290.70

*Without SPC data output

Order No.	Description	List	Promo
05CZA624	40" SPC Cable	\$93.90	\$89.20
05CZA625	80" SPC Cable	\$95.35	\$90.60



ABSOLUTE Digimatic Calipers

- > Electromagnetic inductive sensor improves environmental resistance against dirt, water and oil.
- > A battery life of approximately 3.5 years has been achieved under normal use through the adoption of Mitutoyo's ABSOLUTE scale.
- > The slider configuration features an ergonomic, thumb-friendly shape.
- > Step-measurement capable.
- > The data output function allows integration into statistical process control and measurement systems.
- > Display character height: 9mm
- > * AOS applies to 4", 6" and 8" models



www.mitutoyo.com/aoscd
VIDEO DEMO



500-196-30

SPC ABSOLUTE
Absolute System Patented by MITUTOYO

ABSOLUTE AOS
DIGIMATIC
AOS: Advanced Onsite Sensor

Order No.	Range	Remarks	List	Promo
No SPC Output Style				
500-195-30	0-4" / 0-100mm	.075" Round depth bar	\$144.00	\$136.80
500-196-30	0-6" / 0-150mm		\$156.00	\$148.20
500-197-30	0-8" / 0-200mm		\$224.00	\$212.80
500-193	0-12" / 0-300mm		\$450.00	\$427.50
With SPC Output Style				
500-170-30	0-4" / 0-100mm	.075" Round depth bar	\$172.00	\$163.40
500-171-30	0-6" / 0-150mm		\$183.00	\$173.85
500-172-30	0-8" / 0-200mm		\$241.00	\$228.95
500-173	0-12" / 0-300mm		\$525.00	\$498.75
500-505-10	0-18" / 0-450mm	Without Thumb Roller	\$819.00	\$778.05
500-506-10	0-24" / 0-600mm	Without Thumb Roller	\$900.00	\$855.00
500-507-10	0-40" / 0-1000mm	Without Thumb Roller	\$1,740.00	\$1,653.00

SPC cable with data switch - 1m: 959149 2m: 959150

Dial Calipers

- > Newly designed dial movement for ultra smooth sliding and high shock protection.
- > Lock screw for dial bezel and for holding the sliding jaw position.
- > Can measure OD, ID, depth and steps.
- > Models available with carbide-tipped OD and ID jaws.

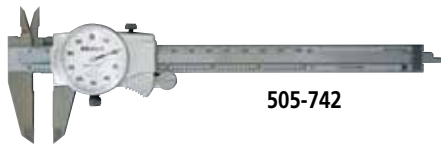

505-742

Order No.	Range	Remarks	List	Promo
505-742	6" .100"/rev.		\$121.00	\$114.95
505-738	6" .100"/rev.	Carbide-Tipped Jaws	\$207.00	\$196.65
505-740	6" .200"/rev.		\$111.00	\$105.45
505-743	8" .100"/rev		\$177.00	\$168.15
505-746	12" .100/rev		\$281.00	\$266.95
505-749	12" .200/rev		\$261.00	\$247.95

Coolant-Proof Carbon-Fiber Caliper with Interchangeable Jaws

- > The range of applications can be expanded by using interchangeable jaws (optional).
- > Quick and easy change of jaws due to the unique clamping mechanism. (A pair of clamping wheels is a standard accessory.)
- > Provided with preset function for setting a desired starting point, which allows direct readout of offset measurements.
- > Resolution: .0005" / 0.01mm

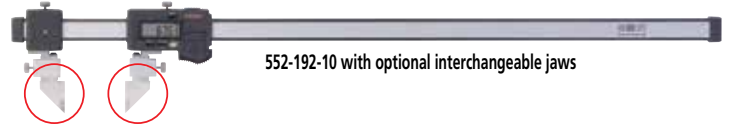

552-192-10 with optional interchangeable jaws

Order No.	Range	Accuracy	List	Promo
552-191-10	0 - 18" / 0 - 450mm	±.002"	\$910.00	\$864.50
552-192-10	0 - 24" / 0 - 600mm	±.002"	\$940.00	\$893.00
552-193-10	0 - 40" / 0 - 1000mm	±.002"	\$1,510.00	\$1,434.50
552-194-10	0 - 60" / 0 - 1500mm	±.004"	\$2,450.00	\$2,327.50
552-195-10	0 - 80" / 0 - 2000mm	±.005"	\$3,430.00	\$3,258.50

SPC cable with data switch - 1m: 05CZA624 2m: 05CZA625

Interchangeable Jaws (optional)

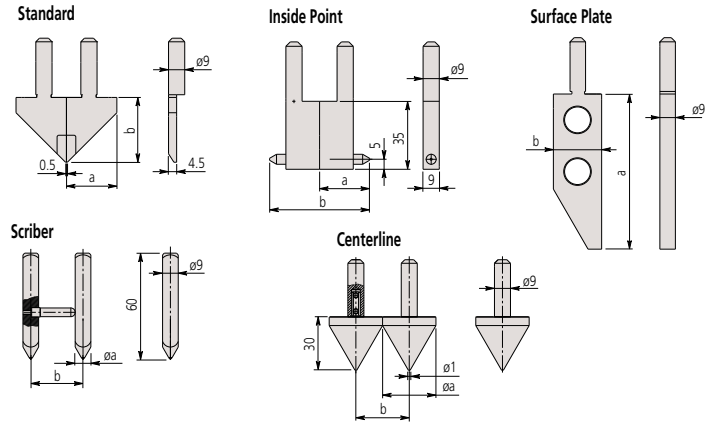

Order No.	Components	a	b	List	Promo
Standard					
07CZA056	Right (07CAA044), Left (07CAA045)	28mm (1.1")	30mm (1.2")	\$308.00	\$292.60
Inside Point					
07CZA058	07CZA041 x 2pcs.	25mm	50mm	\$317.00	\$301.15
07CZA059	07CZA048 x 2pcs.	1"	2"	\$342.00	\$324.90
Scriber					
07CZA055	Right (07CZA042), Left (07CZA043)	8mm	30mm	\$335.00	\$318.25
07CZA061	Right (07CZA042), Left (07CZA049)	031"	1.2"	\$342.00	\$324.90
Surface Plate					
07CZA044		3.5" / 90mm	1.1" / 28mm	\$267.00	\$253.65
Centerline					
07CZA057	07CZA039 x 2pcs.	30mm	30mm	\$342.00	\$324.90
07CZA060	07CZA047 x 2pcs.	1.2"	1.2"	\$317.00	\$301.15

Offset Caliper

- > Main scale jaw can slide up and down to facilitate measurement of stepped sections. (Hard-to-reach dimensions such as A, B, C can be accurately measured.)
- > With depth bar.
- > With SPC data output. (Series 573)

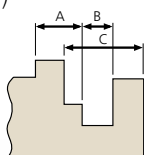

573-701



Order No.	Range	Accuracy	Resolution	List	Promo
573-701	0 - 6" / 0 - 150mm	±.001"	.0005" / 0.01mm	\$464.00	\$440.80
573-702	0 - 8" / 0 - 200mm	±.001"	.0005" / 0.01mm	\$532.00	\$505.40
573-704	0 - 12" / 0 - 300mm	±.0015"	.0005" / 0.01mm	\$714.00	\$678.30

SPC cable with data switch – 1m: **05CZA624** 2m: **05CZA625**

Neck Caliper

- > Point-jaw type can measure wall thickness inside bores and recesses.
- > Flat-jaw type can measure grooves and recesses.
- > With SPC data output.

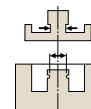

573-752



Order No.	Range	Accuracy	Resolution	List	Promo
573-751	0 - 6" / 0 - 150mm	±.0015"	.0005" / 0.01mm	\$667.00	\$633.65
573-752*	0 - 6" / 0 - 150mm	±.0015"	.0005" / 0.01mm	\$802.00	\$761.90

*Point jaw type

SPC cable with data switch – 1m: **05CZA624** 2m: **05CZA625**

Point Caliper

- > Narrow tip jaws fit into very small grooves and tracks, making many previously difficult outside measurements easier to obtain.
- > With depth bar.
- > With SPC data output.



573-721



Order No.	Range	Accuracy	Resolution	List	Promo
573-721	0 - 6" / 0 - 150mm	±.001"	.0005" / 0.01mm	\$407.00	\$386.65
573-725*	0 - 6" / 0 - 150mm	±.001"	.0005" / 0.01mm	\$505.00	\$479.75

* Extended tips

SPC cable with data switch – 1m: **05CZA624** 2m: **05CZA625**

SPC Connecting Cables (optional)



05CZA624: 1m (40")
05CZA625: 2m (80")



959149: 1m (40")
959150: 2m (80")

Order No.	Description	List	Promo
With Data Out Switch			
05CZA624	1m — IP66/67 Calipers	\$93.90	\$89.20
05CZA625	2m — IP66/67 Calipers	\$95.35	\$90.60
959149	1m - Non IP Calipers, Large Micrometers	\$49.25	\$46.80
959150	1m - Non IP Calipers, Large Micrometers	\$55.20	\$52.45

Low-Force Caliper

- > Due to the low measuring force these calipers are ideal for elastic or resilient workpieces such as plastic parts and rubber parts that standard calipers can't measure consistently.
- > With SPC data output.



Measurement procedures



To measure resilient workpieces, take the measurement when the pointer is between the two index lines.



573-291-30



Order No.	Range	Accuracy	Resolution	List	Promo
573-291-30	0 - 7" / 0 - 180mm	±.002"	.0005" / 0.01mm	\$820.00	\$779.00

SPC cable with data switch – 1m: **959149** 2m: **959150**

Digimatic & Vernier Caliper with Nib-Style Jaws

- > The rounded faces of the jaws are ideal for accurate ID (inside diameter) measurement.
- > With SPC output.

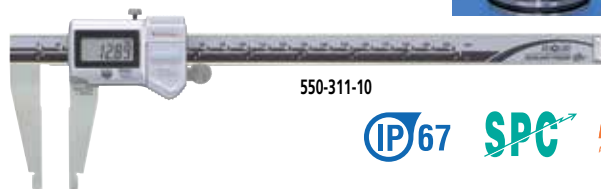
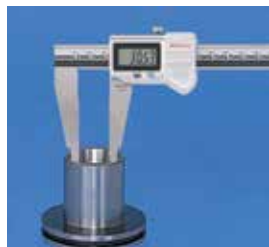

550-311-10



SPC cable with data switch – 1m: **05CZA624** 2m: **05CZA625**

Order No.	Range*	Accuracy	Resolution	List	Promo
550-311-10	0 (.4") - 8" / 0 (10) - 200mm	±.001"	.0005" / 0.01mm	\$525.00	\$498.75
550-341-10	0 (.4") - 12" / 0 (10) - 300mm	±.0015"	.0005" / 0.01mm	\$763.00	\$724.85
550-223-10**	0 (.5") - 18" / 0 (20) - 450mm	±.002"	.0005" / 0.01mm	\$956.00	\$908.20
550-225-10**	0 (.5") - 24" / 0 (20) - 600mm	±.002"	.0005" / 0.01mm	\$1,070.00	\$1,016.50
550-227-10**	0 (1") - 40" / 0 (20) - 1000mm	±.003"	.0005" / 0.01mm	\$1,910.00	\$1,814.50

*(): Minimum dimension in ID measurement **Models are not IP67 rated

Digimatic Caliper with Nib-Style and Standard Jaws

- > The rounded faces of the jaws are ideal for accurate ID (inside diameter) measurement.
- > With SPC output.

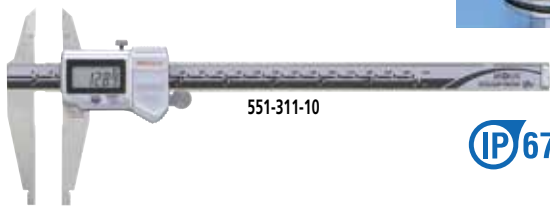

551-311-10



SPC cable with data switch – 1m: **05CZA624** 2m: **05CZA625**

Order No.	Range*	Accuracy	Resolution	List	Promo
551-311-10	0 (.4") - 8" / 0 (10) - 200mm	±.001"	.0005" / 0.01mm	\$579.00	\$550.05
551-341-10	0 (.4") - 12" / 0 (10) - 300mm	±.002"	.0005" / 0.01mm	\$829.00	\$787.55
551-224-10**	0 (.5") - 20" / 0 (20) - 500mm	±.0025"	.0005" / 0.01mm	\$1,220.00	\$1,159.00
551-226-10**	0 (.5") - 30" / 0 (20) - 750mm	±.0025"	.0005" / 0.01mm	\$1,980.00	\$1,881.00
551-227-10**	0 (1") - 40" / 0 (20) - 1000mm	±.003"	.0005" / 0.01mm	\$2,080.00	\$1,976.00

*(): Minimum dimension in ID measurement ** Models are not IP67 rated

Inside Caliper Knife-Edge/Inside Groove/Point-Jaw Type

- > Special ID Jaw Calipers are designed for difficult-to-measure areas, such as ID grooves or recessed areas.
- > With SPC data output.



Knife edge



573-742

Measurable min. hole diameter: \varnothing .4"

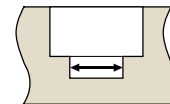

Inside groove



573-745

Measurable min. hole diameter: \varnothing .4"

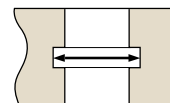

Point jaw



573-746

Measurable min. hole diameter: \varnothing .8"

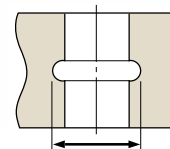

Order No.	Range	Accuracy	List	Promo
573-742	.4" - 8" / 10-200mm	±.002"	\$910.00	\$864.50
573-745	.4" - 6" / 10-150mm	±.002"	\$727.00	\$690.65
573-746	.8" - 6" / 20-150mm	±.0015"	\$883.00	\$838.85

SPC Connecting Cables (optional)



05CZA624: 1m (40")
05CZA625: 2m (80")

Order No.	Description	List	Promo
05CZA624	1m — IP66/67 Calipers With Data Out Switch	\$93.90	\$89.20
05CZA625	2m — IP66/67 Calipers	\$95.35	\$90.60

Calculation-Type Digimatic Indicator ID-C

- Calculation-Type Digimatic Indicator features both a Key-Lock and Parameter-Lock.
- Improved parameter setting software makes it even easier to set all of the available parameters and determine and upload the proper coefficients for calculation. (optional)
- Fast measurement frequency up to 50 per second.
- An analog bar provides easy-to-read values when scanning for Max, Min and TIR Values.
- The Absolute Digimatic indicator performs internal calculations using the formula $Ax+B+Cx-1$ (assuming spindle displacement as x), while the specified coefficients A, B and C can be set with respect to the purpose of measurement or dimensions of the fixtures. This unique feature allows for reading measurements directly, without fumbling for conversions.
- Resolution: .00005"/.0001"/.0005" (0.001/0.01mm) Selectable

Stem dia. 3/8" #4-48 UNF Thread

Order No.	Range	Accuracy	Measuring Force	List	Promo
543-342B	.5"/12.7mm	±.00010"/0.003mm	1.5N or less	\$445.00	\$400.50
543-592B	1"/25.4mm	±.00010"/0.003mm	1.8N or less	\$596.00	\$536.40
543-597B	2"/50.8mm	±.00025"/0.006mm	2.3N or less	\$748.00	\$673.20



www.mitutoyo.com/idccal
VIDEO DEMO



543-342B



Bore Gage ABSOLUTE Digimatic Indicator ID-C

- Bore Gage Digimatic Indicator features both a Key Lock and Parameter Lock.
- Fast measurement frequency up to 50 per second.
- The minimum value holding function provides easy detection of hole diameter.
- An analog bar indicator is integrated to enhance the intuition in reading.
- Up to three sets of master values and upper/lower tolerance values can be memorized.
- Go/no-go judgment
- Employing the ABSOLUTE linear encoder, the ID-C always displays the spindle Absolute Position from the origin at power-on.
- Resolution: .00005"/.0001"/.0005" (0.001/0.01mm) Selectable
- Parameter setting software makes it easier to set all of the available parameters. (optional)

Order No.	Range	Accuracy	Measuring Force	List	Promo
543-312B	.5"/12.7mm	±.00010"/0.003mm	1.5N or less	\$445.00	\$400.50



543-312B



Peak Hold ABSOLUTE Digimatic Indicator ID-C

With Max./Min. Value Holding Function

- Peak Hold Digimatic Indicator features both a Key Lock and Parameter Lock.
- Parameter setting software makes it even easier to set all of the available parameters.
- An analog bar provides easy-to-read values when scanning for Max, Min and TIR Values.
- Go/no-go judgment
- The maximum, minimum or runout value can be displayed during measurement.
- High speed sampling ratio of 50 times/s.
- Employing the ABSOLUTE linear encoder, the Signal ID-C always displays the spindle Absolute Position from the origin at power-on.

Order No.	Resolution	Range	Accuracy	Remarks	List Price	Sale Price
Stem dia. 3/8, #4-48 UNF Thread						
543-302	.00005"/.0001"/.0005" 0.001/0.01mm	.5"/12.7mm	±.00010"/0.003mm	w/lug	\$445.00	\$400.50
543-302B	Selectable	.5"/12.7mm	±.00010"/0.003mm	Flat-back	\$445.00	\$400.50



543-302B



www.mitutoyo.com

IDC Digimatic Indicators

- > Absolute Encoder ensures all settings and readings maintained for the life of the battery (even when the power is turned off).
- > Preset, zero set, inch/mm, +/- direction and go/no-go functions.
- > Face rotates 330° for use at various angles.
- > Stem diameter: .375"
- > Immune to overspeed error.
- > SPC output provided.
- > Average battery life 7,000 hours using SR-44 battery (541980).

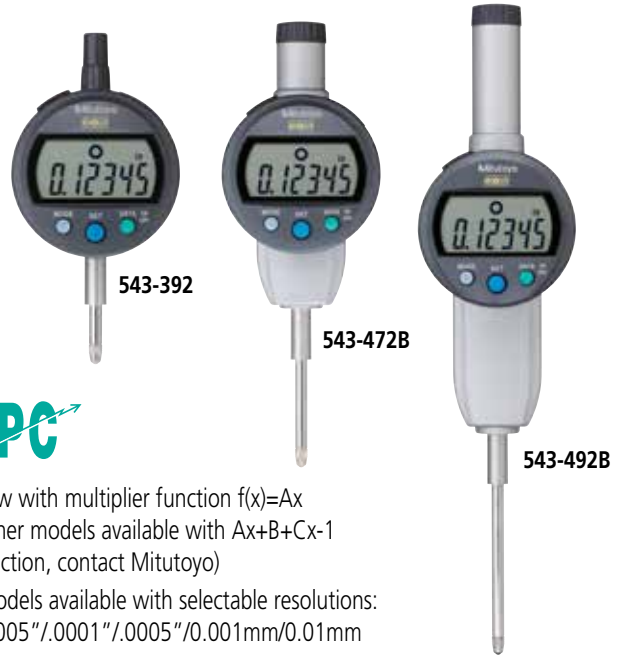

SPC

Now with multiplier function $f(x)=Ax$ (other models available with $Ax+B+Cx-1$ function, contact Mitutoyo)

*Models available with selectable resolutions: .00005"/.0001"/.0005"/0.001mm/0.01mm

Order No.	Range	Remarks	List	Promo
.0005"/0.01mm Resolution				
543-402	.500"/12.7mm	Lug Back	\$310.00	\$294.50
543-402B	.500"/12.7mm	Flat Back	\$310.00	\$294.50
543-476B	1"/25mm	Flat Back	\$454.00	\$431.30
543-496B	2"/50mm	Flat Back	\$597.00	\$567.15
.00005"/.0001"/.0005"/0.001mm/0.01mm Resolution*				
543-392	.500"/12.7mm	Lug Back	\$424.00	\$402.80
543-392B	.500"/12.7mm	Flat Back	\$424.00	\$402.80
543-472B	1"/25mm	Flat Back	\$568.00	\$539.60
543-492B	2"/50mm	Flat Back	\$713.00	\$677.35

Order No.	Description	List	Promo
905338	40" SPC Cable	\$40.05	\$38.05
905409	80" SPC Cable	\$47.75	\$45.35

• Three large buttons

The popular three large-button design, which is used in products such as the ABS coolant-proof Digimatic indicators ID-N/B, makes buttons easier to press and operations easier to perform.



Parameter setting mode

Count direction switching, tolerance judgment setting, resolution switching, scale factor setting and function lock setting

- inch/mm conversion (inch/mm models)

Power switch

- Data output (when connected to an external device)
- Data hold (when no external device is connected)

Switches between the ABS (preset) and INC (zeroset) measurement modes

• 330° rotary display

The display can be rotated 330°, allowing use at a position where you can easily read the measurement value.



Series One Dial Indicators

Mitutoyo's Dial Indicators now offer more stability and longer life, thanks to advances to the inner workings of the rack and pinion gear system. Shock resistance is increased with a more robust gear train, while contamination resistance has been dramatically increased over other indicators of this type with a tighter seal around the bezel and frame, and the elimination of a lifting lever screw.



Order No.	Graduation	Range	Accuracy	Dial Face	List	Promo
1410S	.001"	.25"	±.001"	0-100	\$108.00	\$102.60
1410S-10**	.001"	.25"	±.001"	0-100	\$112.00	\$106.40
1410SB*	.001"	.25"	±.001"	0-100	\$108.00	\$102.60
1506S	.0005"	.125"	±.0005"	0-50	\$99.80	\$94.80
1507S	.0005"	.125"	±.0005"	0-25-0	\$99.80	\$94.80

* with flat back ** jeweled

Series Two Dial Indicators

Order No.	Graduation	Range/Rev	Type	Dial Reading	Accuracy First 2.5 Rev/Overall	Force	List	Promo
2776S	.0005"	1" / .05"	w/lug	0-50	.0005 / .002	2.5N or less	\$142.00	\$134.90



Digimatic Indicator ID-H

> This new-generation digital indicator offers the excellent accuracy and functionality expected from this class of indicator. Take advantage of its high accuracy backed up by 0.5µm / .00002" resolution, remote control functionality via a handheld controller (or an RS-232C interface) and easy runout measurements with the well-established analog bar display.

- > The maximum, minimum or runout value can be displayed during measurement.
- > Go/no-go judgment is performed by setting the upper and lower tolerances. If a judgment result is out of tolerance, the display backlighting changes from green to red, so tolerance judgment can be made at a glance.
- > With RS-232C input/output

21EZA099
Remote controller
(optional)



543-564A



Stem dia. 3/8" #4-48 UNF Thread

Order No.	Resolution	Range	Model	Accuracy	List	Promo
543-562A	.00002", .00005", .0001", 0.0005mm,	1.2" / 30.4mm	ID-H530E	0.0015mm	\$883.00	\$794.70
543-564A	0.001mm	2.4" / 60.9mm	ID-H560E	0.0025mm	\$1,050.00	\$945.00

ABSOLUTE Digimatic Indicator ID-F

- > With the ABSOLUTE linear encoder technology, once the measurement reference point has been preset it will not be lost when the power is turned on.
- > Go/no-go judgment is performed by setting the upper and lower tolerances. If a judgment result is out of tolerance, the display backlighting changes from green to red, so tolerance judgment can be made at a glance.
- > The maximum, minimum or runout value can be displayed during measurement.

> An analog bar indicator has been integrated to handle upper/lower limit approaching and zero approaching. It enhances the ease of operation in the same manner as a dial indicator. The display range of the analog bar can be changed.



543-552A



543-558A



Stem dia. 3/8" #4-48 UNF Thread

Order No.	Resolution	Range	Model	Accuracy	List	Promo
543-552A	.00005", .0001", .0005", .001",	1" / 25.4mm	ID-F125E	.00012"	\$667.00	\$600.30
543-558A	0.001mm, 0.01mm	2" / 50.8mm	ID-F150HE	.00012"	\$773.00	\$695.70

ABSOLUTE Digimatic Indicator ID-U

- > Slim digital indicator with low price.
- > Large LCD and simple key operation.
- > After the initial origin setting, the ID-U no longer needs absolute positioning over the entire battery life; the origin is remembered even after power-off.
- > Ideal for installation into measuring devices because of compact design and long battery life.
- > Employing the ABSOLUTE linear encoder, the ID-U always displays the spindle Absolute Position from the origin at power-on. Also unlimited response speed eliminates over-speed errors.
- > Flat-back type has no option for backs.



575-123



Order No.	Resolution	Range	Model	Accuracy	Measuring force	List	Promo
575-123	.0005"/0.01mm	1" / 25.4mm	ID-U1025E	.0008"	1.8N or less	\$195.00	\$175.50

Digimatic Holtest

- > TiN-coated measuring contact points provide excellent durability and impact resistance and allow the instrument to measure close to the bottom of blind holes (up to 100mm / 4" models).
- > Large LCD readout.
- > Functions available: Presetting, Zero/ABS, Auto power On/Off, Data hold, Data output, Error alarm, Battery replacement alarm.
- > With ratchet stop for constant force.
- > Can measure deep holes by attaching an extension rod (optional).
- > Setting rings are included in sets, but optional for individual gages.
- > Supplied in fitted plastic case up to 100mm / 4". Over 100mm / 4" supplied in wooden case.
- > Resolution: .00005"/0.001mm (over 4" models: .0001"/0.001mm)



468-261



468-263

SAVE 20%



www.mitutoyo.com/dholtest
VIDEO DEMO



468-274

Optional Accessories

- 04AZB157:** Mounting plate for stand
- 156-101-10:** Stand
- 952322:** Extension rod 100mm / 3.94"
For range 6-12mm / .275 - .5" models
- 952621:** Extension rod 150mm / 5.9"
For range 12-20mm / .5" - .8" models
- 952622:** Extension rod 150mm / 5.9"
For range 20-50mm / .8" - 2" models
- 952623:** Extension rod 150mm / 5.9"
For range 50-300mm / 2" - 12" models

Order No	Range	Accuracy	List	Promo
Individual Gages				
468-261	.275 - .35" / 6.925 - 8.89mm	±.0001"	\$1,110.00	\$888.00
468-262	.35 - .425" / 8.89 - 10.795mm	±.0001"	\$1,110.00	\$888.00
468-263	.425 - .5" / 10.795 - 12.7mm	±.0001"	\$1,120.00	\$896.00
468-264	.5 - .65" / 12.7 - 16.51mm	±.0001"	\$1,220.00	\$976.00
468-265	.65 - .8" / 16.51 - 20.32mm	±.0001"	\$1,220.00	\$976.00
468-266	.8 - 1" / 20.32 - 25.4mm	±.00015"	\$1,250.00	\$1,000.00
468-267	1 - 1.2" / 25.4 - 30.48mm	±.00015"	\$1,250.00	\$1,000.00
468-268	1.2 - 1.6" / 30.48 - 40.64mm	±.00015"	\$1,280.00	\$1,024.00
468-269	1.6 - 2" / 40.64 - 50.8mm	±.00015"	\$1,290.00	\$1,032.00
468-270	2 - 2.5" / 50.8 - 63.5mm	±.00015"	\$1,400.00	\$1,120.00
468-271	2.5 - 3" / 63.5 - 76.2mm	±.00015"	\$1,400.00	\$1,120.00
468-272	3 - 3.5" / 76.2 - 88.9mm	±.00015"	\$1,420.00	\$1,136.00
468-273	3.5 - 4" / 88.9 - 101.6mm	±.00015"	\$1,440.00	\$1,152.00
468-274	4 - 5" / 101.6 - 127mm	±.00025"	\$1,880.00	\$1,504.00
468-275	5 - 6" / 127 - 152.4mm	±.00025"	\$1,930.00	\$1,544.00
468-276	6 - 7" / 152.4 - 177.8mm	±.00025"	\$2,050.00	\$1,640.00
468-277	7 - 8" / 177.8 - 203.2mm	±.00025"	\$2,140.00	\$1,712.00
468-278	8 - 9" / 203.2 - 228.6mm	±.00025"	\$2,280.00	\$1,824.00
468-279	9 - 10" / 228.6 - 254mm	±.00025"	\$2,330.00	\$1,864.00
468-280	10 - 11" / 254 - 279.4mm	±.00025"	\$2,410.00	\$1,928.00
468-281	11 - 12" / 279.4 - 304.8mm	±.00025"	\$2,520.00	\$2,016.00
Interchangeable Head Sets				
468-976	.275 - .5" / 6.925 - 12.7mm	±.0001"	\$2,030.00	\$1,624.00
468-977	.5 - .8" / 12.7 - 20.32mm	±.0001"	\$1,650.00	\$1,320.00
468-978	.8 - 2" / 20.32 - 50.8mm	±.00015"	\$4,120.00	\$3,296.00
468-979	2 - 4" / 50.8 - 101.6mm	±.00015"	\$4,720.00	\$3,776.00
468-980	4 - 8" / 101.6 - 203.2mm	±.00025"	\$5,540.00	\$4,432.00
Complete Unit Sets				
468-986	.275 - .5" / 6.925 - 12.7mm	±.0001"	\$3,960.00	\$3,168.00
468-987	.5 - 1" / 12.7 - 25.4mm	±.0001"	\$4,200.00	\$3,360.00
468-988	1 - 2" / 25.4 - 50.8mm	±.00015"	\$4,760.00	\$3,808.00
468-989	2 - 3" / 50.8 - 76.2mm	±.00015"	\$5,350.00	\$4,280.00
468-990	3 - 4" / 76.2 - 101.6mm	±.00015"	\$6,290.00	\$5,032.00

Order No.	Description	List	Promo
05CZA662	40" SPC Cable	\$83.80	\$79.60
05CZA663	80" SPC Cable	\$92.45	\$87.85



04AZB157

Digimatic Height Gages (Multi-Function Type)

Now with two resolutions (.0002"/.0005"), two value preset memory and increased character height for easier viewing.

- > Highly versatile, multi-function type.
- > Carbide-tipped long scriber is provided.
- > Rigid construction ensures repeatable measurement.
- > Switchable resolution.
- > Coarse/fine feed switching.
- > With SPC data output.
- > Two preset reference height.
- > Inclined handle improves slider ergonomics.

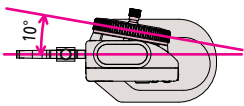

192-670-10

Functions:

- > Zero/ABS setting (ABS and INC modes)
- > Two-value preset memory
- > Data/hold
- > ± Counting
- > Inch/mm conversion

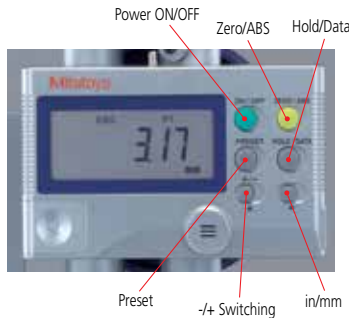

Order No.	Range	Resolution	Accuracy	List	Promo
192-670-10	0-12"/0-300mm	.0005" (0.01mm)	±001"	\$1,770.00	\$1,681.50
192-671-10	0-18"/0-450mm	[.0002" (0.005mm)	±0015"	\$2,280.00	\$2,166.00
192-672-10	0-24"/0-600mm	Switchable]	±0015"	\$2,920.00	\$2,774.00

Order No.	Description	List	Promo
905338	40" SPC Cable	\$40.05	\$38.05
905409	80" SPC Cable	\$47.75	\$45.35



Dial Height Gages

Double-column structure ensures high measuring accuracy. Coarse/fine feed switching. Carbide-tipped scriber.

- > Easy and error-free reading with both up and down digital counters, as well as a dial.
- > Provided with a feed wheel for easy coarse feeding.
- > Carbide-tipped scriber is provided.
- > The counters and dial can be re-zeroed at any scriber position.
- > Fits comfortably in the hand and moves easily on the surface plate.



192-150

Order No.	Range	Graduation	List	Promo
192-150	0-12"	.001"	\$1,010.00	\$959.50
192-151	0-18"	.001"	\$1,400.00	\$1,330.00
192-152	0 - 24"	.001"	\$1,820.00	\$1,729.00



IMTS2016

International Manufacturing Technology Show
September 12 - 17, 2016 · McCormick Place · Chicago

VISIT US
AT BOOTH **E-5215**

Linear Height LH-600E

The Mitutoyo Linear Height LH-600E offers advanced performance for reliable and easy 2D measurement.

Measuring Range (stroke) 0-38" (24") / 0-972mm (600mm)

- > True 2D measurement
- > High Accuracy: $(1.1+0.6L/600)\mu\text{m}$
(L=Length of mm)
- > Measuring Range (Stroke): 0-38" (24"), 0-972mm (600mm)
- > Selectable Resolution: .000001"/.00001"/.0001"/.001"
/0.0001mm/0.001mm /0.01mm/0.1mm
- > Basic statistical functions are provided.
- > RS-232C / USB data output provides the option of evaluating measurement data externally with SPC software on a PC.
- > One-key operation for running semiautomatic measurement.
- > Data entry from a digimatic tool.
- > Highest functionality: 21 parameters
- > Accepts multiple probes.
- > Pneumatic full/semi floating system.
- > Holds 60,000 data points.
- > Memory for 50 measuring points.
- > Bright, back-lit LCD

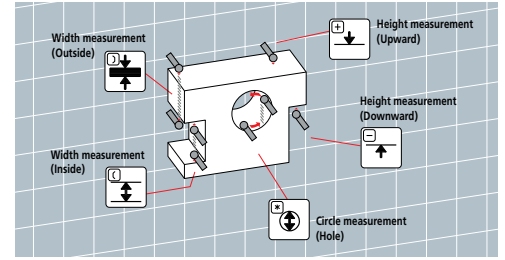

Purchase a Linear Height LH-600E and Receive a **Free** Digimatic Tool Kit! *
(valued at \$397.00)



*Tool Kit: **64PKA076B**

Caliper: 500-196-30, Micrometer: 293-340-30,
Mahogany Case: 64PPP932

List: **\$8,480.00**

Order No. **PROMO002**

OR

Save 5%

On the Purchase of a
Linear Height LH-600E

List: \$8,480.00

Promo: \$8,056.00

Order No. 518-351A-21

PV-5110 Profile Projector

- > Large 500mm screen
- > Floor model uses a downward illumination system.
- > Digital readout protractor screen (including zero-setting, ABS/INC coordinate switching functions) for easy and error-free angle measurement.
- > Angled screen allows projected images to be easily traced or compared with a template.
- > The oblique surface illumination system provides clear and bright images, allowing easy inspection of non-reflective workpieces such as plastic parts or printed materials.

Standard Accessories

- > 200 x 100mm (8 x 4") XY travel
- > 10x projection lens set
- > Surface illumination unit
- > Counter stand for KA counter
- > Power cord, halogen bulb, fuse, grounding wire, allen wrench, vinyl cover



PV-5110



Order No.	Description	List	Promo
304-919A	Profile Projector PV-5110	\$24,200.00	\$21,780.00
264-156A	QM-Data200 (Arm-Mount Model)	\$2,720.00	\$2,584.00
332-151	Optoeye-200	\$1,650.00	\$1,485.00
12AAE672	Attachment (B) for Optoeye-200	\$58.65	\$55.70
174-183A	KA 200 Counter	\$587.00	\$528.30



KA 200 Counter

PJ-A3000 Vertical Profile Projector

- > A series of midsize profile projectors featuring bright, 12.40" (315mm) diameter screens and easy-to-operate XY measurement tables.
- > A floating table makes measuring quick and easy.
- > Built-in, easy-to-read digital counters are located near the projection screen, thereby minimizing strain associated with excessive movement.
- > For edge-sensing capabilities, order the Optoeye-200, part number 332-151.



PJ-A3010F-200

Order No.	Description	XY Travel	List	Promo
302-701A	PJ-A3010F-200	8" x 4"	\$13,600.00	\$12,920.00
302-702A	PJ-A3005F-150	6" x 2"	\$12,000.00	\$11,400.00
302-703A	PJ-A3010F-100	4" x 4"	\$10,800.00	\$10,260.00
302-704A	PJ-A3005D-50	2" x 2"	\$8,890.00	\$8,445.50

Optional Accessories

Order No.	Description	List	Promo
264-156A	QM-Data 200 (Arm-Mount Model)	\$2,720.00	\$2,584.00
332-151	Optoeye 200	\$1,650.00	\$1,485.00
64PMI167	Stand for PJ-A3000	\$688.00	\$653.60
12AAA807	RS-232C Cable	\$54.30	\$51.60
12AAE671	Attachment board (A) for Optoeye-200	\$40.80	\$38.80

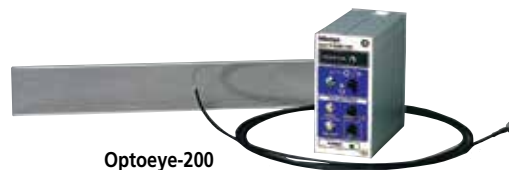

Optoeye-200



QM Data

Rectangular Steel Gage Block Sets

> All Mitutoyo gage blocks meet or exceed all known specifications. The flatness, parallelism and surface finish necessary to achieve the required accuracies are the same as or better than government requirements.



516-930-26



516-902-26



516-914-26

Order No.	Blocks per Set	Grade	Size	Step	Qty	List	Promo
516-902-26	81	0	.1001 - .1009"	.0001"	9	\$1,970.00	\$1,871.50
			.101 - .149"	.001"	49		
			.05 - .95"	.05"	19		
			1 - 4"	1"	4		
516-903-26	81	AS-1	.1001-.1009"	.0001"	9	\$1,710.00	\$1,624.50
			.101-.149"	.001"	49		
			.05-.95"	.05"	19		
			1-4"	1"	4		
516-904-26	81	AS-2	.1001-.1009"	.0001"	9	\$1,550.00	\$1,472.50
			.101-.149"	.001"	49		
			.05-.95"	.05"	19		
			1-4"	1"	4		
516-914-26	35	0	.10005"		1	\$1,040.00	\$988.00
			.1001-.1009"	.0001"	9		
			.101-.149"	.001"	9		
			.11-.19"	.01"	9		
			.1-.3"	.1"	3		
			.5, 1, 2, 4"		4		
516-947-26	87	AS-1	1.001-1.009mm	0.001mm	9	\$2,460.00	\$2,337.00
			1.01-1.49mm	0.01mm	49		
			0.5-9.5mm	0.5mm	19		
			10-100mm	10	10		

Order No.	Blocks per Set	Grade	Blocks Incl. In Set	Remarks	List	Promo
516-930-26	9	0	.0625", .100", .125", .200", .250", .300", .500" 1", 2"	Optical parallel (t = .5")	\$360.00	\$342.00
516-931-26	9	AS-1			\$314.00	\$298.30
516-935-26	9	AS-1	.0625", .100", .125", .200", .250", .300", .500", 1", 2"		\$242.00	\$229.90

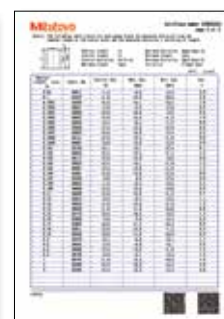

> A Certificate of Accuracy, traceable to NIST, is furnished with each gage block set.

Mitutoyo SPC Cables

Mitutoyo SPC cables for tools with Mitutoyo Digimatic SPC output.



959149: 1m (40")
959150: 2m (80")



05CZA662: 1m (40")
05CZA663: 2m (80")



05CZA624: 1m (40")
05CZA625: 2m (80")



937387: 1m (40")
965013: 2m (80")

Order No.	Length	Pins	For Use With	List	Promo
With Data Out Switch					
05CZA624	40"	—	IP66/67 Calipers	\$93.90	\$89.20
05CZA625	80"	—	IP66/67 Calipers	\$95.35	\$90.60
05CZA662	40"	—	IP65 Micrometers	\$83.80	\$79.60
05CZA663	80"	—	IP65 Micrometers	\$92.45	\$87.85
959149	40"	—	Height Gage 570 Series, Digimatic Indicator 543 and 575 Series, Digimatic Scale Unit 572 Series, Digimatic Absolute Calipers	\$49.25	\$46.80
959150	80"	—	Height Gage 570 Series, Digimatic Indicator 543 and 575 Series, Digimatic Scale Unit 572 Series, Digimatic Absolute Calipers	\$55.20	\$52.45
Without Data Out Switch					
937387	40"	6	Borematic 568 Series	\$50.85	\$48.30
965013	80"	6	Borematic 568 Series	\$60.10	\$57.10
905338	40"	—	Height Gage 570 Series, Digimatic Indicator 543 and 575 Series, Digimatic Scale Unit 572 Series	\$40.05	\$38.05
905409	80"	—	Height Gage 570 Series, Digimatic Indicator 543 and 575 Series, Digimatic Scale Unit 572 Series	\$47.75	\$45.35

Prices effective September 6 through December 16, 2016

High-Accuracy Digimatic Micrometer with Resolution of 0.0001mm / .000005"



Resolution: 0.0001mm

The High-Accuracy Digimatic Micrometer utilizes Mitutoyo's innovative 0.1µm resolution ABS (absolute) rotary sensor and high-accuracy screw machining technology to reduce the instrumental error to ±0.5µm, delivering higher accuracy (0.1µm) without sacrificing operability.



COOLANT PROOF

COOLANT PROOF™

COOLANT PROOF is the universal term of Mitutoyo Digimatic Small Tool Instruments that are free from measurement error and physical deterioration due to routine exposure to water, cutting oil or coolant. This high performance is achieved by using encoders that are inherently immune to contamination, where exposure is inevitable, combined with comprehensive sealing techniques and extremely oil-resistant materials to guarantee a long working life under normal operating conditions.



Light-weight Carbon Fiber Caliper

QuantuMike with 2mm/rev Spindle Feed—4X Faster, Same Accuracy



IP65

Faster measurement is achieved by using a finer thread which feeds the spindle by 2mm per revolution of the thimble instead of the standard 0.5mm. This increase of spindle feed has been made possible thanks to new high-precision thread-cutting and test techniques. In addition, the ratchet thimble mechanism ensures repeatable results and enables easy operation even when making one-handed measurements.

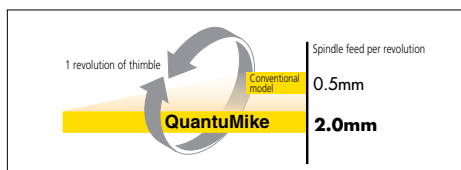



IMTS2016

The Americas' Largest Manufacturing Show

The International Manufacturing Technology Show is one of the largest industrial trade shows in the world, featuring more than 2,000 exhibiting companies and 114,147 registrants. The event is held every two years.

September 12-17, 2016 | McCormick Place, Chicago

VISIT US AT BOOTH E-5215

© 2016 Mitutoyo America Corporation



Whatever your challenges are, Mitutoyo supports you from start to finish.

Mitutoyo is not only a manufacturer of top-quality measuring products but one that also offers qualified support for the lifetime of the equipment, backed by comprehensive services that ensure your staff can make the very best use of the investment.

Apart from the basics of calibration and repair, Mitutoyo offers product and metrology training, as well as IT support for the sophisticated software used in modern measuring technology. We can also design, build, test and deliver measuring solutions and even, if deemed cost-effective, take your critical measurement challenges in-house on a sub-contract basis.



Find additional product literature and our product catalog

www.mitutoyo.com

Distributed by:

Mitutoyo

Mitutoyo America Corporation

www.mitutoyo.com

One Number to Serve You Better

1-888-MITUTOYO (1-888-648-8869)

M³ Solution Centers:

Aurora, Illinois (Headquarters)

Boston, Massachusetts

Huntersville, North Carolina

Mason, Ohio

Plymouth, Michigan

City of Industry, California

Birmingham, Alabama

Renton, Washington

Houston, Texas

Note: All information regarding our products, and in particular the illustrations, drawings, dimensional and performance data contained in this printed matter as well as other technical data are to be regarded as approximate average values. We therefore reserve the right to make changes to the corresponding designs. The stated standards, similar technical regulations, descriptions and illustrations of the products were valid at the time of printing. In addition, the latest applicable version of our General Trading Conditions will apply. Only quotations submitted by ourselves may be regarded as definitive. Specifications are subject to change without notice.

Mitutoyo products are subject to US Export Administration Regulations (EAR). Re-export or relocation of our products may require prior approval by an appropriate governing authority.

Trademarks and Registrations

Designations used by companies to distinguish their products are often claimed as trademarks. In all instances where Mitutoyo America Corporation is aware of a claim, the product names appear in initial capital or all capital letters. The appropriate companies should be contacted for more complete trademark and registration information.