

Fowler[®]
HIGH PRECISION

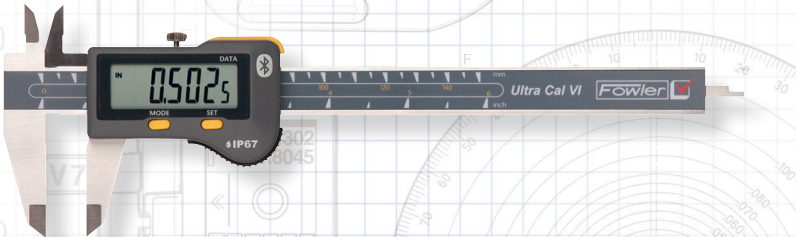

Over 80 NEW items!



TOOL-A-THON

Vol. 17.1

Valid Jan. 1st - April 30th

Visit us at www.fowlerprecision.com

HEIGHT GAGES

Fowler-Trimos V3, V4 & V5 Electronic Height Gages

The Fowler-Trimos V3, V4 and V5 vertical measuring instruments have been developed for the most difficult workshop environments. Manufactured in their entirety in Switzerland, they guarantee a robust, precise and reliable product in the long run.

- Measuring ranges 400mm, 700mm and 1100mm
- Extremely easy to use
- "Black mask" display with user friendly functions
- Electronically adjustable measuring force 0.75/1.5 (N)
- Lithium-ion rechargeable batteries
- Vast range of accessories
- All adjustments possible without tools
- Cast iron base for optimal stability
- RS-232 and USB interfaces requires 54-192-112-0 cable
- Air cushion (V4 and V5 Only)
- Dual probe holders (V4 and V5 Only)
- Carriage displacement: Manual
(V5 includes selectable manual or motorized carriage displacement)
- Measures heights, diameters, perpendicularity, centerlines, Min/Max/Delta
- Accessory measuring probes up to 340mm in length available and provide excellent repeatability
- Resolution: 0.00005"/0.001mm
- Repeatability (2s): 0.00008"/0.002mm (Ø 0.00016"/0.004mm)



All V Models Include:

- Charging unit
- Measuring insert with ruby ball Ø4mm
- Probe holder elbow Ø 8mm
- Setting gage
- User's manual
- Test certificate

V3	54-192-340-0	54-192-370-0
Measuring Range	16"/407mm	28"/711mm
Range with Probe inverted	20"/508mm	31.9"/812mm
Max. Permissible Errors	0.00028"/0.007mm	0.00032"/0.008mm
Frontal Squareness Deviation	0.0004"/0.010mm	0.0006"/0.015mm
Air Cushion	NO	

V4	54-191-440-0	54-191-470-0
Measuring Range	16"/407mm	28"/711mm
Range with Probe inverted	28.3"/719mm	40.2"/1023mm
Max. Permissible Errors	0.0002"/0.005mm	0.00028"/0.007mm
Frontal Squareness Deviation	0.0004"/0.010mm	0.0006"/0.015mm
Air Cushion	YES	

V5	54-199-540-0	54-199-570-0	54-199-590-0
Measuring Range	16"/407mm	28"/711mm	43.7"/1100mm
Range with Probe inverted	28.3"/719mm	40.2"/1023mm	56"/1422mm
Max. Permissible Errors (µm)		2.5 + L(mm)/300	
Frontal Squareness Deviation	0.0002"/0.005mm	0.00032"/0.008mm	0.00043"/0.011mm
Air Cushion	YES		



Swiss Quality!



Order No.	Description	Range	List Price	Sale Price
54-192-340-0	V3 Height Gage	16"/407mm	\$4366.62	\$4015.00
54-192-370-0	V3 Height Gage	28"/711mm	4814.40	4428.00
54-191-440-0	V4 Height Gage	16"/407mm	5751.78	5290.00
54-191-470-0	V4 Height Gage	28"/711mm	6691.20	6155.00
54-199-540-0	V5 Height Gage	16"/407mm	6339.30	5673.00
54-199-570-0	V5 Height Gage	28"/711mm	7512.30	6723.00
54-199-590-0	V5 Height Gage	43"/1100mm	11620.86	10400.00
Probe Sets				
54-199-105-0	4mm Probe Set, 21 piece		\$1679.94	\$1595.00
54-199-106-0	8mm Probe Set, 16 piece		1253.58	1190.00
54-199-107-0	Economy Probe Set, 7 piece		445.00	420.00

HEIGHT GAGES - Accessories

Fowler-Trimos Height Gage Probe Kits

4mm Probe Set

- Case
54-199-502-0 Disc-shaped insert Ø 7.7mm
Disc-shaped insert Ø 11.5mm
54-199-503-0 Corner insert 1mm
54-194-948-0 Measuring insert holder for: M2.5, M1.6, M1.4
54-199-507-0 Insert holder L=80mm M2.5
54-199-508-0 Insert holder 90° L=80mm Ø 4mm
54-199-512-0 Measuring insert holder Ø 1mm
54-199-509-0 Ruby Ball Probe Ø 2mm
Ball Probe Ø 1mm
54-199-510-0 Knife-edged measuring probe L=88mm
54-199-019-0 Holder with reduction 8mm/4mm
54-194-935-0 Swivel holder Ø4/Ø8mm
- Hemispheric probe
Probe with pin (plus 4 additional pins)
Test indicator tip Ø 1mm
Test indicator tip Ø 2mm
Test indicator tip Ø 3mm
Key for ball insert
Hex wrench 1.5mm
Hex wrench 2.5mm



54-199-105-0

8mm Probe Set

- Case
54-194-910-0 Carbide Ball Probe Ø 4mm L 140mm
54-194-906-0 Carbide Ball Probe Ø 2mm
54-194-912-0 Carbide Probe with pin Ø 1.5mm
54-194-938-0 Swivel holder 90° Ø 4mm
54-194-942-0 Measuring insert holder Ø 2mm
54-194-930-0,931-0 Insert holder (metric) M2.5
54-199-505-0 Insert holder L=124mm M2.5
Insert holder L=200mm M2.5
Hemispheric probe tip
Disc-shaped insert Ø 18mm
Test indicator tip Ø 1mm
Test indicator tip Ø 2mm
Test indicator tip Ø 3mm
Key for ball tip
Hex wrench 2.5mm



54-199-106-0

Economy Probe Set

- Case
54-199-503-0 Corner insert 1mm
54-199-504-0 Measuring insert M2.5 with ball contact
54-199-515-0 Hex wrench 2.5mm
54-194-906-0 Carbide ball probe Ø 2mm
54-194-942-0 Measuring insert holder Ø 2mm
54-194-938-0 Measuring insert holder 90°, Ø 4mm, L= 65mm



54-199-107-0

12"/300mm Probe Holder

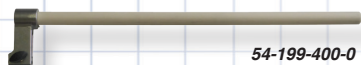

54-199-400-0

Order No.	Description	List Price	Sale Price
54-199-105-0	4mm Probe Set, 21 piece	\$1679.94	\$1595.00
54-199-106-0	8mm Probe Set, 16 piece	1253.58	1190.00
54-199-107-0	Economy Probe Set, 7 piece	445.00	420.00
54-199-400-0	12"/300mm Holder — for 8mm probes	940.34	890.00

Prices & Specifications are subject to change without notice.





HEIGHT GAGES

Hi_Cal Height Gages

- Extra low measuring force, from 0.2N
- Measurement of internal and external diameters, centerlines, heights, widths and depths
- MIN/MAX/TIR capability
- Excellent repeatability thanks to the motorized carriage
- Intuitive functions/minimizes key strokes
- Great mobility
- High reliability
- Data output USB and RS-232
- Battery life: 40 hours rechargeable during operation
- Touch sensitive probe speed for easy operation
- Base with small footprint

Includes: protective cover, charging set, ruby ball probe Ø3mm, setting gage and calibration certificate

Save \$500

Accessory Probe Sets



54-930-215-0



54-930-217-0



54-931-300-0

FREE Basic Probe Set
with 54-931-450-0 Hi_Cal Purchase
\$593.00 Value!

FREE 1mm Ball Probe with 6"/150mm & 12"/300mm Hi_Cal Purchase

Order No.	Range	Accuracy	List Price	Sale Price
54-931-150-0	6"/150mm	0.00013"/0.0034mm	\$4661.50	\$4160.00
54-931-300-0	12"/300mm	0.00016"/0.0042mm	5357.04	4850.00
54-931-450-0	17.5"/450mm	0.00020"/0.005mm	5608.98	5100.00
Accessories				
54-930-215-0	Full Probe Accessory Set		\$1093.95	\$975.00
54-930-217-0	Basic Probe Accessory Set		593.64	530.00

HEIGHT GAGES

Hi_Gage One

The Fowler-Sylvac measuring system is exceptionally fast (60" per second traverse) and is the most reliable and maintenance free system ever created for measurement

- True inch/metric conversion
- Resolution: 0.0005"/0.01mm
- Repeatability: 0.0004"/10µm
- Base size: 5.6" wide x 6.8" length
- Accuracy 0.0016"/0.002"
- Includes scriber/measuring probe
- Direct RS-232 output
- **Scale not affected by oil, dust, chips, magnetism, shock, etc.**



54-212-024-1



Super Smooth Movement!

Order No.	Range	List Price	Sale Price
54-212-016-1	16"/400mm	\$1455.13	\$1225.00
54-212-024-1	24"/600mm	1812.34	1425.00
Cables			
54-115-526-0	Proximity Cable with USB Connection	\$136.07	\$122.00
54-115-527-0	Proximity Cable with Serial Connection	136.07	122.00

Electronic Height Gage

An economical height gage that offers high quality, accuracy and durability.

- Large base for easy movement
- True inch/metric conversion
- Range: 0 - 20"/500mm
- Resolution: 0.0005"/.01mm
- Accuracy: ± 0.0025"
- Repeatability: 0.0005"/0.01mm (±2s)
- Deluxe wooden case with reinforced metal edges
- Large easy to read LCD
- Non-glare chrome reading surface
- Overall height: 28"
- Beam thickness: 1.25 X 0.4"
- Presetable display

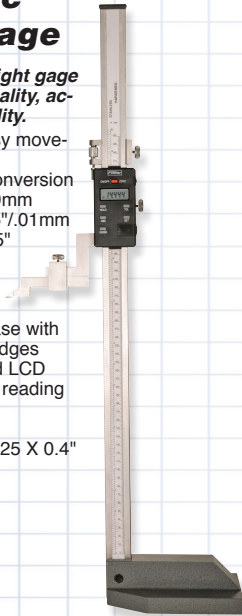

Order No. 54-106-020-0

Sale \$258.00
List \$401.60

Twin Beam Dial Height Gages

- Separate digit counters register both upward & downward travel.
- Zero setting can be obtained throughout the gage's range.
- Coarse readings in 0.100" graduations: fine readings taken on indicator are 0.001"
- Dual chrome plated beams.
- Carbide-tipped scriber.
- Base is hardened, ground & lapped for maximum flatness.

Accuracy	
52-174-212-0	±0.0015"
52-174-224-0	±0.002"

52-174-212-0

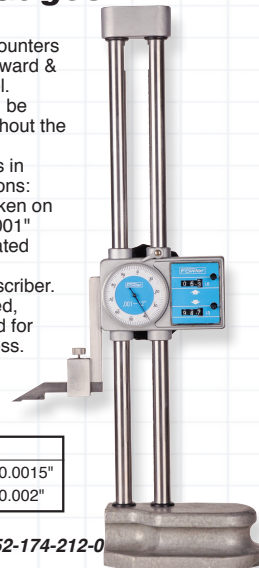

Order No.	Range	List Price	Sale Price
52-174-212-0	12"	\$355.25	\$295.00
52-174-224-0	24"	723.68	595.00

Fowler

TOOL-A-THON Vol. 17.1



Find us on social media!

Prices & Specifications are subject to change without notice.



LIFETIME WARRANTY

LIFETIME WARRANTY

We are so confident that these Fowler-Sylvac Mark VI electronic indicators are the most accurate, most dependable, best made products you can buy, we are extending the warranty to last a lifetime!

*NO Gimmicks
NO Hurdles
NO Nonsense*

Quality, accuracy, dependability, world-class customer service and now a real Lifetime Warranty!

Mark VI Electronic Indicators

- Robust construction
- Water and coolant resistant
- Protection class IP54
- Repeatability: 2 μ m
- Output: Proximity/Power - USB/RS-232/digimatic/Wireless
- Battery life: 10,000 hours of operation
- Menus customizable with free software
- Wide range of functions (MIN/MAX/DELTA, TOL, Factor, Preset, Auto Off, etc)
- Aluminum housing
- Bezel rotates 270°
- Large display with LED tolerance indicators
- Includes lug back



This Button is programmable for common functions
54-530-135-0

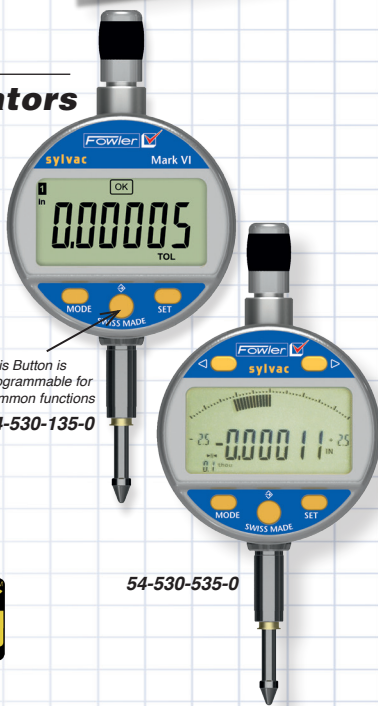

54-530-535-0

Order No.	Description	Maximum Error	Resolution	List Price	Sale Price
54-530-125-0	0 - 0.500"/12.5mm	0.0004"/0.01mm	0.0005"/0.01mm	\$430.75	\$387.50
54-530-135-0	0 - 0.500"/12.5mm	0.00012"/0.003mm	0.00005"/0.001mm	535.81	482.00
54-530-145-0	0 - 1"/25mm	0.0004"/0.01mm	0.0005"/0.01mm	491.64	442.00
54-530-155-0	0 - 1"/25mm	0.00016"/0.004mm	0.00005"/0.001mm	588.34	529.50
54-530-175-0	0 - 2"/50mm	0.00019"/0.005mm	0.00005"/0.001mm	1113.64	1002.00
Bluetooth					
54-530-335-0	0 - 0.500"/12.5mm	0.00012"/0.003mm	0.00005"/0.001mm	682.89	614.60
54-530-355-0	0 - 1"/25mm	0.00016"/0.004mm	0.00005"/0.001mm	730.22	657.20
Accessories					
54-115-246-BT	USB Bluetooth Receiver			47.33	42.60
Analog Display					
54-530-535-0	0 - 0.500"/12.5mm	0.00012"/0.003mm	0.00005"/0.001mm	619.85	557.80
54-530-555-0	0 - 1.00"/25mm	0.00016"/0.004mm	0.00005"/0.001mm	677.69	608.00

LIFETIME WARRANTY

Ultra-Cal V Electronic Calipers



54-100-067-1

Buy 5, Get 1 FREE!

LIFETIME WARRANTY



- 4-way measurement, inside, outside, depth and step. (6" & 8" models)
- Hardened stainless steel construction
- Direct RS-232 output
- Features Absolute/Relative Measuring Modes
- Thumbroll (6" model only)

Order No.	Description	Accuracy	Resolution	List Price	Sale Price
54-100-667-0	Buy 5 standard 6"/150mm Electronic Calipers (54-100-067-1), Get 1 FREE			\$992.95	\$742.50
54-100-067-1	6"/150mm	0.0008"/20µm	0.0005"/0.01mm	\$198.59	\$148.50
54-100-068-1	8"/200mm	0.0012"/30µm	0.0005"/0.01mm	472.77	352.00
54-100-069-1	12"/300mm	0.0012"/30µm	0.0005"/0.01mm	567.32	425.00
Connectivity Kits					
54-115-526-0	Proximity cable with USB connection			\$136.07	\$122.00
54-115-527-0	Proximity cable with serial connection			136.07	122.00



Bluetooth Ultra-Cal VI Electronic Calipers



54-100-167-1

NEW!

LIFETIME WARRANTY



- New Design
- IP67 rated
- Available with or without Bluetooth
- Heavy duty frame
- Extra large display

Order No.	Description	Accuracy	Resolution	List Price	Sale Price
Bluetooth					
54-100-167-0	NEW 6"/150mm	0.0008"/20µm	0.0005"/0.01mm	\$330.99	\$290.00
54-100-168-0	NEW 8"/200mm	0.0012"/30µm	0.0005"/0.01mm	614.65	465.00
54-100-169-0	NEW 12"/300mm	0.0012"/30µm	0.0005"/0.01mm	819.47	545.00
Without Bluetooth					
54-100-177-0	NEW 6"/150mm	0.0008"/20µm	0.0005"/0.01mm	\$115.00	\$109.00
54-100-178-0	NEW 8"/200mm	0.0012"/30µm	0.0005"/0.01mm	235.00	223.00
54-100-179-0	NEW 12"/300mm	0.0012"/30µm	0.0005"/0.01mm	315.00	295.00
Connectivity Kit					
54-115-526-0	Proximity cable with USB connection			\$136.07	\$122.00
54-115-527-0	Proximity cable with serial connection			136.07	122.00
54-115-246-BT	USB bluetooth receiver			47.33	42.60

Prices & Specifications are subject to change without notice.



Find us on social media!



Fowler® TOOL-A-THON Vol. 17.1

HIGH RESOLUTION

Micron 0.0005" Electronic Caliper

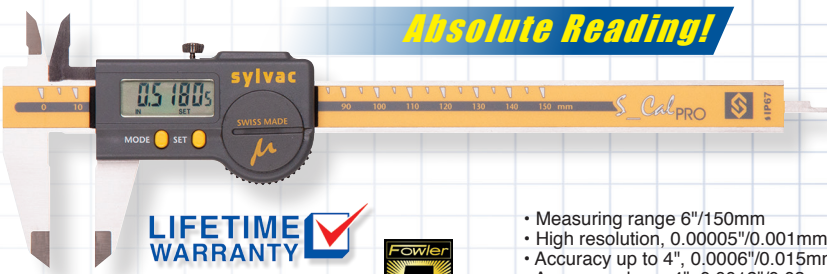

Absolute Reading!

LIFETIME WARRANTY



IP67

Fowler
5
FIVE YEAR WARRANTY

- Measuring range 6"/150mm
- High resolution, 0.00005"/0.001mm
- Accuracy up to 4", 0.0006"/0.015mm
- Accuracy above 4", 0.0012"/0.03mm
- Repeatability 0.00016"/0.004mm
- RS-232 output
- Heavy duty frame (3.5mm)

Order No. 54-100-100-0

Sale \$345.00 List \$384.54

Mark VI Nano Electronic Indicators

- Accuracy: 0.00007"/0.0018mm - 0.5" model
0.00008"/0.0022mm - 1" model
- 0.00001"/0.0001mm resolution
- 0.00002"/0.0005mm repeatability
- Large display
- IP54 rated
- Bluetooth available

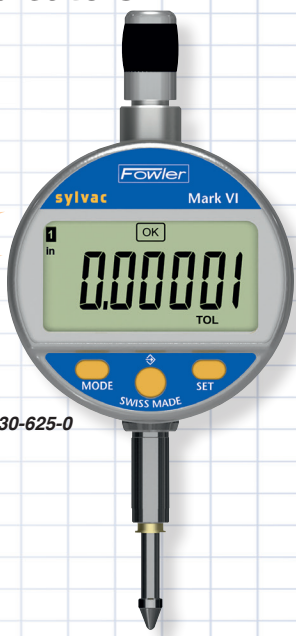

LIFETIME WARRANTY



Fowler
5
FIVE YEAR WARRANTY

Protected to:
IP54
COOLANT & FLUID
RESISTANT

54-530-625-0

Order No.	Description	Accuracy	Resolution	List Price	Sale Price
Without Bluetooth					
54-530-625-0	NEW 0.5"/12.5mm	0.00007"/0.0018mm	0.00001"/0.0001mm	\$1040.00	\$885.00
54-530-630-0	NEW 1"/25mm	0.00008"/0.0022mm	0.00001"/0.0001mm	1129.00	960.00
Bluetooth					
54-530-635-0	NEW 0.5"/12.5mm	0.00007"/0.0018mm	0.00001"/0.0001mm	\$1239.70	\$1055.00
54-530-640-0	NEW 1"/25mm	0.00008"/0.0022mm	0.00001"/0.0001mm	1260.00	1130.00

HIGH RESOLUTION

S Dial Pro High Accuracy Indicators

NEW!

- 0.00001"/0.0002mm repeatability
- 0.000005"/0.0001mm resolution
- 0.00006"/0.0015mm accuracy
- 2"/50mm range
- Mixed ceramic bearing/ball bearing system
- Includes spindle lifting attachment
- IP54 rated
- Available with or without spring tension
- 8mm or 25mm mounting diameter



54-530-705-0



54-530-700-0

LIFETIME WARRANTY 



Order No.	Description	Accuracy	Resolution	List Price	Sale Price
54-530-700-0	8mm mount with spring	0.00006"/0.0015mm	0.000005"/0.0001mm	\$2652.80	\$2350.00
54-530-705-0	25mm mount with spring	0.00006"/0.0015mm	0.000005"/0.0001mm	2652.80	2350.00
54-530-710-0	8mm mount without spring	0.00006"/0.0015mm	0.000005"/0.0001mm	2652.80	2350.00
54-530-715-0	25mm mount without spring	0.00006"/0.0015mm	0.000005"/0.0001mm	2652.80	2350.00

Fowler

TOOL-A-THON Vol. 17.1



Find us on social media!

CALIBRATION

SHOP-BLOX® Rectangular Gage Block Sets



53-672-081-0

- Manufactured to meet N.I.S.T. Federal Specification ASME B89. 1.9 - 2002 tolerances on length for inch gage blocks
- Certificate of Calibration traceable to N.I.S.T.
- Tolerances to $\pm 0.00005''$
- In high-quality fitted wood case



Order NO.	Description	List Price	Sale Price
53-672-036-0	36 piece Economy Rectangular Gage Block Set	\$303.13	\$211.00
53-672-081-0	81 piece Economy Rectangular Gage Block Set	518.44	360.00

Grade Ø Rectangular Steel Gage Block Sets



53-670-038-0

- Grade Ø
- Each block certified to N.I.S.T.
- Each block is individually serialized
- Sizes clearly marked on each block
- Complete with fitted wooden case

Order No.	Description	List Price	Sale Price
53-670-038	36 piece Grade Ø Rectangular Gage Block Set	\$461.03	\$320.00
53-670-080	81 piece Grade Ø Rectangular Gage Block Set	848.41	650.00

X-Glide Lubricant and Protectant

- Specifically formulated for precision tools
- Synthetic lubricant enriched with multiple anti-friction additives
- Sub-micron particle size allows for maximum penetration and durability
- Antistatic additive prevents the attraction of dust and dirt
- Contains no solvents, propellants or flammable gases
- PH neutral
- 2.5 oz. spray bottle

Save 50%

FREE with any above Gage Block Set Purchase!

Order No. 53-885-105-0

Sale \$5.00

List \$10.51



Fowler® TOOL-A-THON Vol. 17.1

CALIBRATION

Long Rectangular Gage Blocks

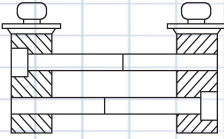

53-670-777-0 holding clamp set used for holding two large blocks together

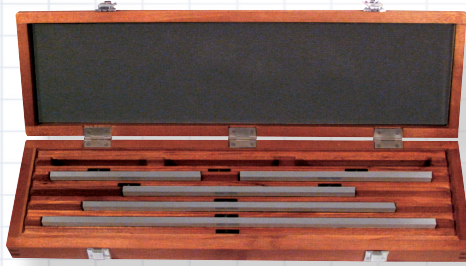

53-670-008-0

- Fowler's long gage blocks are rectangular in shape, Grade \emptyset and supplied with an NIST certificate
- Stackable using holding clamps

Order No.	Description	List Price	Sale Price
53-675-216-0	5" Gage Block	\$169.58	\$144.00
53-675-218-0	6" Gage Block	205.91	174.00
53-675-220-0	7" Gage Block	236.25	200.00
53-675-222-0	8" Gage Block	266.49	223.00
53-675-224-0	10" Gage Block	302.82	255.00
53-675-226-0	12" Gage Block	320.99	270.00
53-675-228-0	16" Gage Block	375.48	310.00
53-675-230-0	20" Gage Block	478.49	400.00
53-670-008-0	8 piece Gage Block Set	1781.69	1625.00
53-670-777-0	Holding Clamp for two large blocks	97.61	72.00

Large Square Gage Blocks

- Grade \emptyset
- NIST Traceable
- Vertically more stable than rectangular blocks
- Large sizes help eliminate block stacks
- Meets or exceeds Federal Specifications ASME B89.1.9-2002

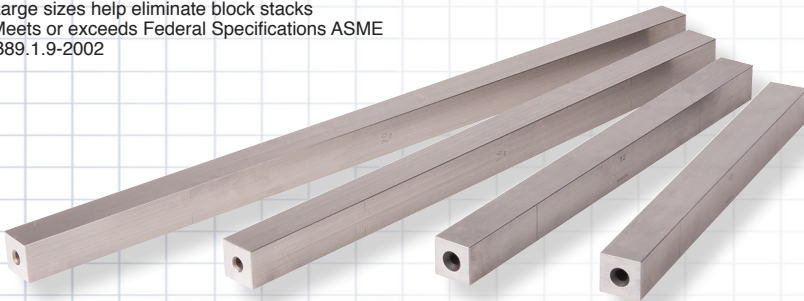

Order No.	Description	List Price	Sale Price
53-676-216-0	5" Large Square Gage Block	\$226.07	\$190.00
53-676-218-0	6" Large Square Gage Block	271.43	230.00
53-676-220-0	7" Large Square Gage Block	311.43	260.00
53-676-222-0	8" Large Square Gage Block	367.71	310.00
53-676-224-0	10" Large Square Gage Block	511.56	430.00
53-676-226-0	12" Large Square Gage Block	568.89	480.00
53-676-228-0	16" Large Square Gage Block	854.39	720.00
53-676-230-0	20" Large Square Gage Block	996.03	840.00

Prices & Specifications are subject to change without notice.



CALIBRATION

QUICK CHECK Multi-Function Check Standard

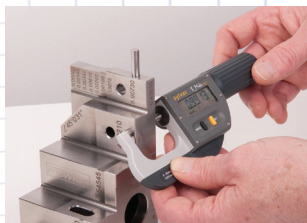

- One compact, multi-function, precise standard
- Can be used to check and verify a multitude of measuring instruments
- Checks calipers, micrometers, depth gages, bore gages, test and dial indicators, caliper gages, height gages, protractors, combination sets and more
- Supplied with a manufacturer's test certificate and fitted wood case
- All sizes marked are actual

Order No. 53-813-015-0

Sale \$1320.00

List \$1580.74

Setting Masters

Fowler's Setting Masters are quick, easy and extremely accurate. Each comes with a manufacturer's certificate of calibration and a wood case. Save time and money by calibrating your own measuring tools.

Depth Micrometer Checker 53-813-005-0

- Ideal for quick, easy calibration and zero setting of depth micrometers
- Range: 0-6"
- Graduation: 1"
- Accuracy: ± 0.000120 "
- Reference block: $1" \pm 0.000020$ "

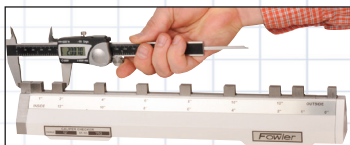

Caliper/Height Gage Checker 53-813-010-0

- Horizontal and vertical use
- Used for the calibration of height gages and calipers
- Scale on one side reads: 0.5", 2", 4", 6", 8", 10" and 12" for inside caliper measurements
- Scale on side reads: 1", 2", 4", 6", 8", 10" and 12" for height gage and caliper checking
- Accuracy: ± 0.0002 "



Order No.	Range	List Price	Sale Price
53-813-005-0	6" Depth Micrometer Checker	\$1538.31	\$1375.00
53-813-010-0	12" Caliper/Height Gage Checker	1505.45	1250.00

CALIBRATION

Micrometer Calibration Set with steel blocks & optical flats



- Grade 0
- 11 Pc. 9 rectangular gage blocks and two optical flats.
- Includes NIST Certificate
- Assists in meeting both Federal specification GGG-C-105c and ISO 9000 requirements.
- Contains one block of each of the following sizes: 0.0625, 0.100, 0.125, 0.200, 0.250, 0.300, 0.500, 1.000 & 2.000"
- TWO OPTICAL FLATS that vary in size by .0125" which allows checking anvil faces at half revolutions of spindle for checking flatness and parallelism
- Supplied with fitted wooden case

Order No. 53-670-002-0

Sale \$215.00

List \$265.02

Caliper, Micrometer, Snap Gage Checking Set

Fowler's setting master is quick, easy and extremely accurate. It comes with a certificate of calibration and a fitted aluminum case. Save time and money by calibrating your own measuring tools quickly and easily.

Set Includes:

- Calibration certification traceable to N.I.S.T. standards
- Stand height: 12.5"
- 9 pc. Grade AS-0 gage block set (sizes: 0.625", 0.100", 0.125", 0.200", 0.250", 0.300", 0.500", 1.000" & 2.000"
- Certificate of calibration is traceable to N.I.S.T. standards & provides the individual deviation of each block
- Optical flat (flatness: 0.000004" ; Parallelism: 0.00002")
- 4.0mm ball end T-handle hex wrench



**Worn blocks
can be
easily replaced!**



Fowler®

TOOL-A-THON Vol. 17.1



Find us on social media!
[f](#)
[E](#)
[in](#)
[You Tube](#)

Order No.	Description	List Price	Sale Price
53-813-001-2	Complete caliper, Micrometer and Snap Gage Checking Set	\$327.92	\$250.00
53-813-002-0	Mic Checker Holder <i>without</i> Blocks	164.34	145.00

Prices & Specifications are subject to change without notice.

CALIBRATION

X-TENDED RANGE[®] Pin Gage Set Minus and Plus Tolerances

Ideal for checking hole size, location, gage slots, distance between holes, go/no-go gaging and setting other gages and micrometers.



**Two ranges
in one set!**
0.011" - 0.060" & 0.061" - 0.250"



53-880-823-0

Features:

- Class ZZ
- Black oxide finish offers extra protection against corrosion and rust, promotes longer life, and highlights wear trends that enables calibration to be performed more effectively
- 240 pcs
- Range: 0.011" - 0.250" in .001" increments.
- Set includes 2 handles and our X-Glide all purpose teflon lubricant
- Certificate of accuracy traceable to N.I.S.T. and registered ISO 9001

Order No.	Description	Accuracy	List Price	Sale Price
53-880-823-0	Plus Pin Gage Set	+0.0002", -0.0000"	\$241.54	\$160.00
53-880-833-0	Minus Pin Gage Set	+0.0000", -0.0002"	241.54	160.00

Pin Gage Handles

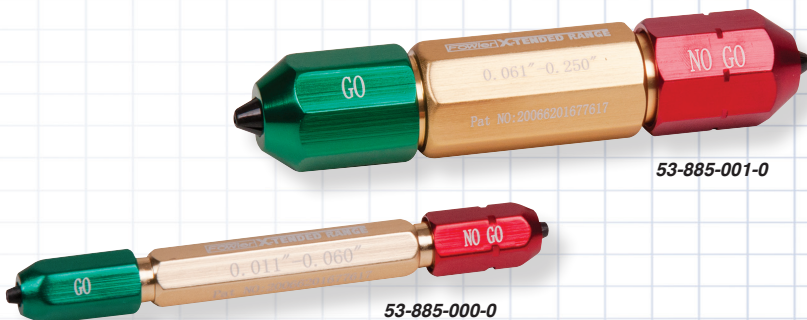

- 8 sizes cover a full range of pin gages (0.011" - 1.0")
- Color coded handle for GO, NO/GO applications
- Both handle and collets are made of aluminum for pin protection
- Collets are spring loaded and self-centering

Order No.	Description	List Price	Sale Price
53-885-000-0	0.011" - 0.060"	\$19.08	\$15.00
53-885-001-0	0.061" - 0.250"	22.45	18.00
53-885-002-0	0.251" - 0.500"	26.38	21.00
53-885-003-0	0.501" - 0.625"	29.19	23.00
53-885-004-0	0.626" - 0.750"	35.70	28.00
53-885-005-0	0.751" - 0.832"	38.96	32.00
53-885-006-0	0.833" - 0.916"	43.26	35.00
53-885-007-0	0.917" - 1.0"	48.72	40.00
53-885-008-0	All Sizes 0.011" - 1.0"	248.75	200.00

CALIBRATION

Cylindrical Squares

- Used for checking squares, height gages and other instruments
- Hardened and the ends are lapped to 90° angular accuracy
- 6" cylindrical squares: ± 0.0001 "
- 12" cylindrical square: ± 0.00015 "
- Includes handles and wood case

52-750-012-0

52-750-006-0



Order No.	Description	List Price	Sale Price
52-750-006-0	6" cylindrical square	\$189.32	\$170.00
52-750-012-0	12" cylindrical square	270.38	240.00

Bore Gage Setting Master Kit - Inch & Metric

Fowler's Bore Gage Setting Master Kit is used for accurately setting any bore gage up to 6"/150mm in diameter to an accuracy of 0.0001"/0.003mm.

Each Set includes:

Setting Device (53-646-000-1 - Inch Model)

- Base anvil: 3.950" x 1.050"
- Adjustable anvil 2.375" x .375" (two each)
- Internal capacity: 6"/150mm
- Depth capacity: 1"/25mm
- Centralizer capacity width: 2.750"
- Quick-release holder for fast adjustment
- **Can also be used for external setting, depending on application (external mics, snap gages, caliper gages)**

Economy Gage Block Sets

Inch model:

- 36 piece
- Tolerances to .00005"
- Certificate of Calibration to N.I.S.T.

Metric model:

- 33 piece
- AS-2 grade
- Certificate of Calibration to N.I.S.T.

Includes:
Bore gage setting master and gage block set.
All in a custom-fitted case!



53-646-000-1

Order No.	Description	List Price	Sale Price
53-646-000-1	Inch Bore Gage Setting Master Kit	\$297.47	\$221.00
53-646-010-0	Standard Metric Bore Gage Setting Master Kit — SPECIAL PRICE!	309.98	195.00

Prices & Specifications are subject to change without notice.

15

Fowler®

TOOL-A-THON Vol. 17.1



Find us on social media!

f

e

in

YouTube

VERNIER CALIPERS

Light Line Vernier Calipers

NEW!

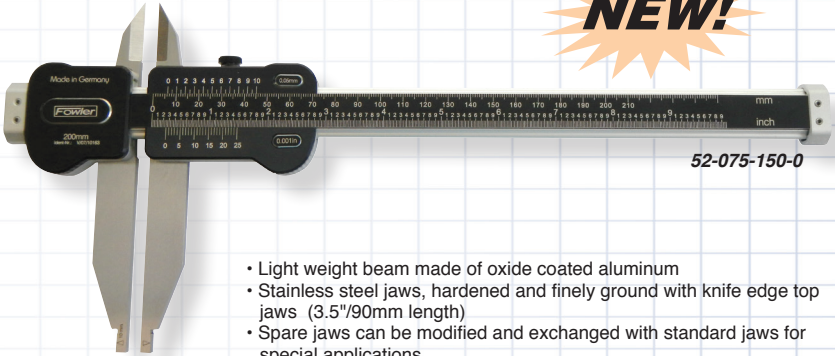

52-075-150-0

- Light weight beam made of oxide coated aluminum
- Stainless steel jaws, hardened and finely ground with knife edge top jaws (3.5"/90mm length)
- Spare jaws can be modified and exchanged with standard jaws for special applications
- Parallax free vernier scale for ease of reading
- High contrast white numbering on black anodized frame
- Inch and metric graduations (0.001"/0.05mm)



Made in
GERMANY

Order No.	Description	Accuracy	List Price	Sale Price
52-075-018-0	NEW 19"/500mm	0.001"/0.03mm	\$360.00	\$342.00
52-075-035-0	NEW 35"/900mm	0.0015"/0.04mm	650.00	617.00
52-075-150-0	NEW 6"/150mm - Replacement Jaws		100.00	95.00

Master Vernier Calipers

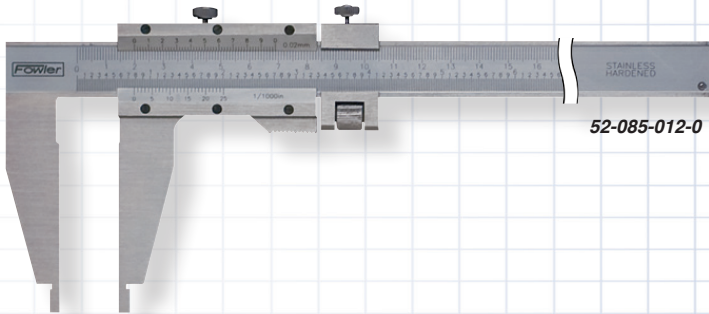

52-085-012-0

- Satin chrome finish on all models
- Hardened stainless steel throughout
- Extra long vernier scales
- Machine divided and engraved from master for exceptional accuracy
- Open face design permits both vernier scales to be located on one side of the gage for both inside and outside measurements
- All sizes permit inside and outside measurements
- For larger workpieces, the long jaws permit greater accessibility and easier measurements

Order No.	Description	Graduation	Jaw Depth	List Price	Sale Price
52-085-012-0	12"/300mm	0.001"/0.02mm	3"	\$174.69	\$131.00
52-085-024-0	24"/600mm	0.001"/0.02mm	4"	370.70	275.00
52-085-040-0	40"/1000mm	0.001"/0.02mm	5-1/2"	867.36	645.00
52-085-060-0	60"/1500mm	0.001"/0.02mm	7-1/2"	2432.86	1750.00

DIAL CALIPERS

Machinist Grade Dial Calipers

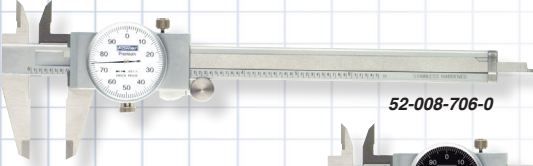

52-008-706-0

- 4-way measuring
- Solid stainless steel construction
- 0.100"/2mm range per revolution
- 0.001"/0.02mm reading dial face
- Tough shockproof gearing

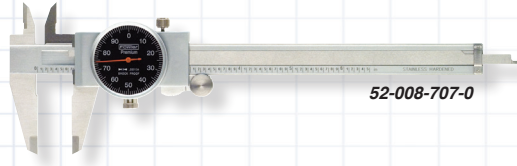

52-008-707-0



Order No.	Description	Dial Face Color	List Price	Sale Price
52-008-706-0	0 - 6"	White	\$74.78	\$55.00
52-008-707-0	0 - 6"	Black	74.78	55.00
52-008-709-0	0 - 150mm (Metric Model)	Yellow	74.78	55.00
52-008-708-0	0 - 8"	White	93.83	73.00

Dial Cal Plus

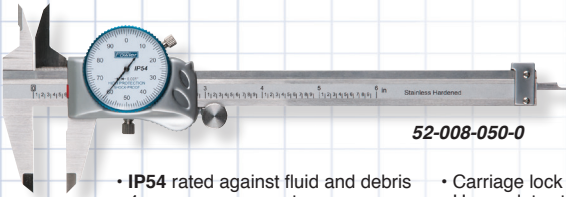

52-008-050-0



- IP54 rated against fluid and debris
- 4-way measurement
- 0.100" per revolution
- Thumbroll for fine adjustment
- Carriage lock screw
- Heavy duty stainless steel frame - 4mm thick
- Adjustable bezel with lock

Order No.	Description	Accuracy	Graduation	List Price	Sale Price
52-008-050-0	0 - 6" - White-face	± 0.001"	0.001"	\$118.45	\$99.00
52-008-051-0	0 - 6" - Black-face	± 0.001"	0.001"	118.45	99.00
52-008-052-0	0 - 150mm - White-face	± 0.03mm	0.02mm	118.45	99.00

0-6" Dial Calipers

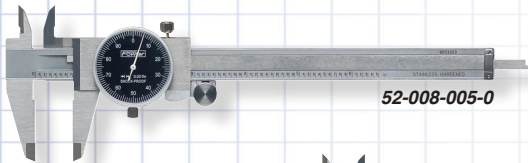

52-008-005-0



- 4-way measuring
- Covered rack
- 0.100" per revolution
- Dial graduation: 0.001"
- Accuracy: ± 0.001"
- Hardened stainless steel rack

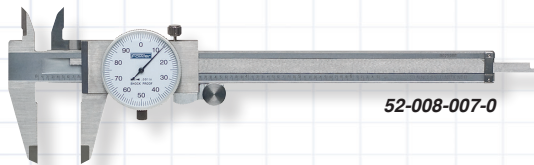

52-008-007-0

Order No.	Dial Face Color	List Price	Sale Price
52-008-005-0	Black	\$89.71	\$50.45
52-008-007-0	White	89.71	50.45

Prices & Specifications are subject to change without notice.





DIAL CALIPERS

One-Rev Dial Calipers

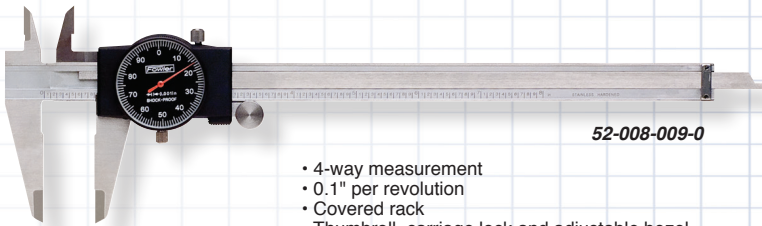

52-008-009-0

- 4-way measurement
- 0.1" per revolution
- Covered rack
- Thumbroll, carriage lock and adjustable bezel
- Hardened stainless steel

Order No.	Range	Accuracy	Graduation	List Price	Sale Price
52-008-009-0	0 - 8"	± 0.0015"	0.001"	\$135.45	\$104.95
52-008-013-0	0 - 12"	± 0.002"	0.001"	173.45	85.95

Heavy Duty Dial Calipers with Cross Jaws

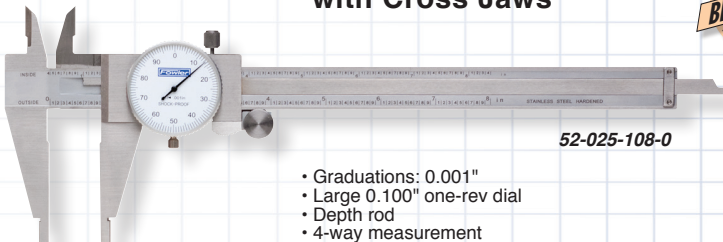

52-025-108-0

- Graduations: 0.001"
- Large 0.100" one-rev dial
- Depth rod
- 4-way measurement
- Cross-jaws for direct internal measurement
- Stainless steel, satin chrome finish



Order No.	Range	Jaw Length	List Price	Sale Price
52-025-108-0	8" Caliper	2.5"	\$136.06	\$78.00
52-025-112-0	12" Caliper	2.875"	197.86	129.00

Extended Range Dial Calipers

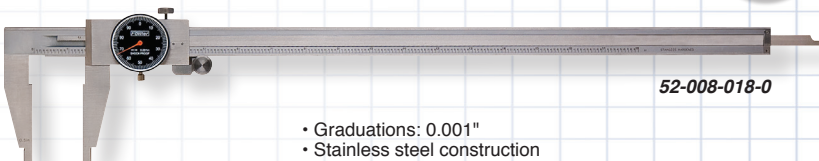

52-008-018-0

- Graduations: 0.001"
- Stainless steel construction
- Satin chrome finish
- Depth rod
- 0.500" internal measuring nibs



Order No.	Range	Depth of Jaws	List Price	Sale Price
52-008-018-0	18" Caliper	3.125"	\$247.10	\$154.00
52-008-024-0	24" Caliper	3.375"	299.42	232.00

ELECTRONIC CALIPERS

XTRA-VALUE CAL Electronic Calipers



54-101-600-1



NEW!

NEW Caliper Design for 54-101-150-2 Model!

Now available with optional N.I.S.T. Certification!



54-101-150-2

- Accuracy: 0.001"/0.02mm (6" models)
- Stainless steel frame
- Large easy-to-read display
- Resolution: 0.0005"/0.01mm
- Direct inch/metric conversion
- Absolute/Incremental Measurement
- 4-way measuring
- Also available with super large display

Order No.	Range	Display Type	List Price	Sale Price
54-101-150-2	6"/150mm	Regular Display	\$47.79	\$35.00
54-101-150-C	6"/150mm	Regular Display with N.I.S.T Certificate		68.00
54-101-600-1	6"/150mm	Super Large Display with hold feature	59.43	39.60
54-101-800-1	8"/200mm	Super Large Display with hold feature	89.10	67.00
54-101-900-1	12"/300mm	Super Large Display with hold feature	118.97	89.00

Poly-Cal[®] Electronic Caliper

Absolute Reading!



Polycarbonate Caliper Includes

- Fractional Measurement
- Easy-To-Read Display
- Lightweight frame

- Range 6"/150mm
- Polycarbonate frame
- Resolution 0.0005"/.01mm (Fractions by 1/64" increments)
- Absolute/Incremental Measurement
- Direct inch/metric/fraction conversion
- 4-way measuring
- Accuracy $\pm 0.008"$
- Supplied with clip-on vinyl pouch

Order No. 54-101-175-0

Sale \$17.50

List \$26.06

Fowler[®]

TOOL-A-THON Vol. 17.1



Find us on social media!

ELECTRONIC CALIPERS

Wireless Transmitter For Economy Calipers & IP54 Calipers

Wireless Transmitter allows wireless input from Economy and IP54 Economy Calipers (below) as well as Indi-Max Indicators (pg. 43). Input directly in to Excel, Word, Cad and Notepad.

- Includes 1 USB receiver and 1 Transmitter (good for 1 tool)
- Audible as well as LED indications when data is sent
- Input into Excel, Word, Notepad and CAD programs with the press of a button.
- Simple plug and play operation
- Wireless technology allows the use of the tool up to 60 feet away from a computer



- Economy IP54 Calipers**
- Economy Calipers** **Indi-X Indicators (pg.43)**

Order No. 54-115-100-0

Sale \$89.50

List \$99.50

4" thru 12" Economy Digital Calipers

Absolute Reading!

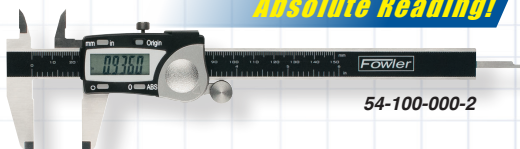

54-100-000-2

- Absolute sensor technology
- Stainless steel frame
- Accuracy: 0.001"/.02mm (4" & 6" models) 0.0015"/0.04mm (8" & 12" models)
- Resolution: 0.0005"/0.01mm



Order No.	Range	List Price	Sale Price
54-100-004-2	0 - 4"/100mm Caliper	\$99.81	\$59.85
54-100-000-2	0 - 6"/150mm Caliper	116.39	78.00
54-100-008-2	0 - 8"/200mm Caliper	136.68	107.50
54-100-112-2	0 - 12"/300mm Caliper	178.19	123.00
54-520-399-0	Data Cable	152.90	140.00

Water Resistant IP54 Electronic Calipers

Absolute Reading!



54-100-777-2



- Water resistant to IP54 specifications
- Absolute sensor technology
- Stainless steel frame
- Accuracy: 0.001"/.02mm (6" model) 0.0015"/0.04mm (12" model)
- Resolution: 0.0005"/0.01mm

Order No.	Range	List Price	Sale Price
54-100-777-2	0 - 6"/150mm Electronic IP54 Caliper	\$130.71	\$90.50
54-100-712-2	0 - 12"/300mm Electronic IP54 Caliper	190.14	133.00
54-520-399-0	Data Cable	152.90	140.00

ELECTRONIC CALIPERS

Ultra-Cal IV Electronic Calipers

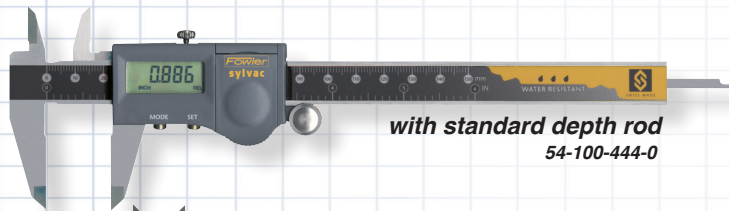

with standard depth rod
54-100-444-0

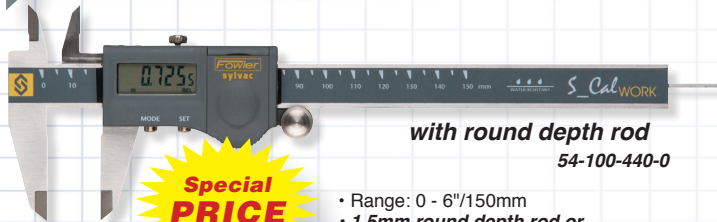

with round depth rod
54-100-440-0

**Special
PRICE**

- Range: 0 - 6"/150mm
- 1.5mm round depth rod or standard depth rod available
- IP54 rated
- Resolution: 0.0005"/0.01mm
- Direct RS-232 output
- Features Absolute/Relative Measuring Modes
- Hold function



Swiss Quality!



Order No.	Description	Accuracy	List Price	Sale Price
54-100-440-0	0 - 6"/150mm Caliper w/round depth rod	0.0008"/0.02mm	SPECIAL PRICE!	\$91.00
54-100-444-0	0 - 6"/150mm Caliper w/standard depth rod	0.0008"/0.02mm	\$138.00	118.00
Connectivity Kit				
54-115-333-0	Opto Serial Connection Kit		\$127.50	114.00
54-115-525-0	Opto USB Connection Kit		156.57	140.00

EURO-CAL IV[®] Electronic Calipers

INCH • METRIC • FRACTION[™]



54-100-330-1

- Absolute/Incremental Measurement
- Water resistant to IP54 standards
- Resolution: 0.0005"/0.01mm (Fractions in 1/64" increments)
- Stainless steel frame
- 4-way measuring

Protected to:
IP54
COOLANT & FLUID
RESISTANT

Order No.	Description	Accuracy	List Price	Sale Price
54-100-330-1	6"/150mm Euro-Cal IV Electronic Caliper	± 0.001"/0.02mm	\$118.76	\$89.00
54-100-331-0	8"/200mm Euro-Cal IV Electronic Caliper	± 0.001"/0.02mm	140.60	105.00

Prices & Specifications are subject to change without notice.

21

Fowler[®]

TOOL-A-THON Vol. 17.1



Find us on social media!



ELECTRONIC CALIPERS

Light Line Electronic Calipers



54-112-012-0

NEW!

- Light weight beam made of oxide coated aluminum
- Stainless steel jaws, jaws are adjustable and exchangeable
- Spare jaws can be modified and exchanged with standard jaws for special applications
- Both jaws are moveable to any position on the main beam
- Electronics feature on/off, floating zero and direct in/mm conversion
- 0.0005"/.01mm resolution and repeatability
- Includes a fitted case, instructions and test certificate.
- Replacement jaws available



Order No.	Range	Accuracy	List Price	Sale Price
54-112-012-0	NEW 0 - 12"/300mm	0.0015"/0.04mm	\$295.00	\$280.00
54-112-030-0	NEW 0 - 31"/800mm	0.002"/0.06mm	680.00	645.00
52-075-150-0	6" Replacement Jaws		100.00	95.00

XTRA-RANGE[®] Electronic Calipers

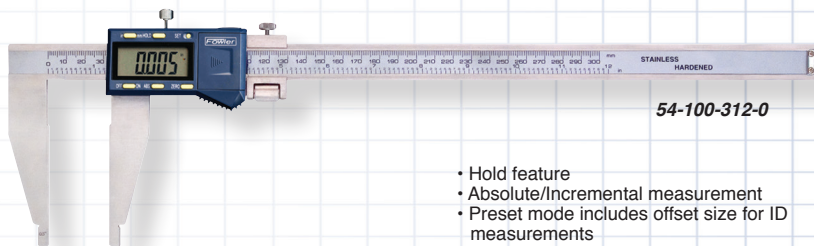

54-100-312-0

- Hold feature
- Absolute/Incremental measurement
- Preset mode includes offset size for ID measurements
- All sizes feature fine adjustment screw
- Resolution: 0.0005"/0.01mm

Shop-Hardened Case!

Order No.	Range	Jaw Depth	Accuracy	List Price	Sale Price
54-100-312-0	0 - 12"/300mm Caliper	3.5"	0.002"/0.04mm	\$205.59	\$149.00
54-100-024-1	0 - 24"/600mm Caliper	4"	0.003"/.08mm	299.42	223.00
54-100-042-1	0 - 40"/1000mm Caliper	4.9"	0.004"/10mm	1229.61	695.00

ELECTRONIC CALIPERS

Fowler-Sylvac Ultralight IV Electronic Calipers

The Fowler-Sylvac Ultralight IV, new design, new features, built-in Bluetooth transmitter. Discover our amazing Ultralight long range calipers.

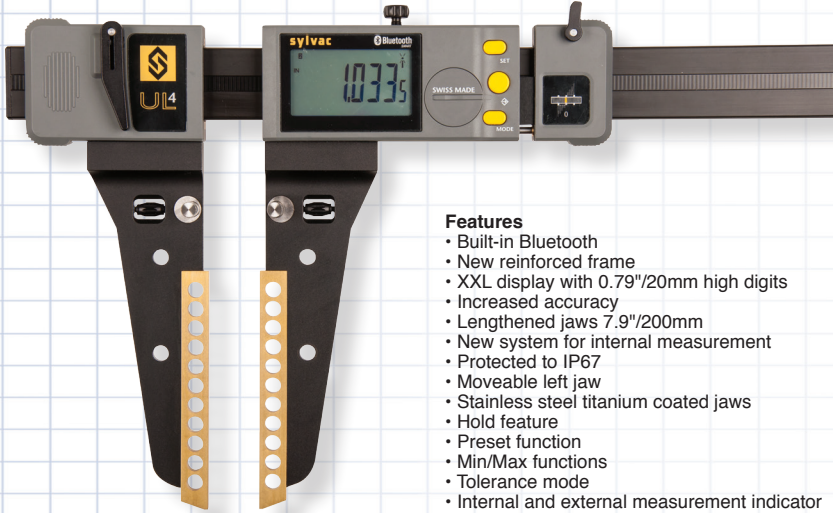

Features

- Built-in Bluetooth
- New reinforced frame
- XXL display with 0.79"/20mm high digits
- Increased accuracy
- Lengthened jaws 7.9"/200mm
- New system for internal measurement
- Protected to IP67
- Moveable left jaw
- Stainless steel titanium coated jaws
- Hold feature
- Preset function
- Min/Max functions
- Tolerance mode
- Internal and external measurement indicator
- New twin guided main beam



Alternative jaws available, contact the Fowler Technical Department for more information 1-800-788-2353

Specifications	54-110-512-0	54-110-524-0	54-110-540-0	54-110-560-0	54-110-580-0	54-110-600-0
Measuring Range	0-15"/0-400mm	0-24"/0-600mm	0-40"/0-1000mm	0-60"/0-1500mm	0-80"/0-2000mm	0-100"/0-2500mm
Maximum Error	30µm/0.0012"	40µm/0.0016"	50µm/0.002"	90µm/0.0035"	120µm/0.0048"	200µm/0.0078"
Repeatability	20µm/0.0008"			30µm/0.0012"		
Measuring Force	5 - 10 N					
Connection	Bluetooth Smart/Proxi. - RS-232 or - USB					
Protection Rating	IP67 (Electronic Module)					
Preset Max.	±9999.99 mm / ±399.9995 IN					
Weight	1.5 kg	1.6 kg	1.9 kg	2.3 kg	2.6 kg	2.9 kg

Order No.	Description	List Price	Sale Price
54-110-512-0	0-15"/0-400mm Ultralight IV	\$2128.23	\$1810.00
54-110-524-0	0-24"/0-600mm Ultralight IV	2482.99	2060.00
54-110-540-0	0-40"/0-1000mm Ultralight IV	2857.63	2325.00
54-110-560-0	0-60"/0-1500mm Ultralight IV	4296.95	3585.00
54-110-580-0	0-80"/0-2000mm Ultralight IV	5920.18	5030.00
54-110-600-0	0-100"/0-2500mm Ultralight IV- <i>special order</i>	7154.59	6080.00
Cables			
54-115-526-0	Proximity USB Cable	\$136.07	\$122.00
54-115-527-0	Proximity Serial Cable	136.07	122.00
54-115-246-BT	USB Bluetooth Receiver	47.33	42.60

Prices & Specifications are subject to change without notice.



MICROMETERS

0.5" Outside Micrometer



- 0 - 0.5" micrometer by 0.001", satin chrome finish
- Anvil and spindle hardened and precision ground with microlapped ends.
- Clear, crisp graduations on barrel and thimble
- Diameter of measuring faces: 0.0197"

Order No. 52-230-000-0

Sale \$29.50

List \$33.82

Outside Micrometers

with Decimal Equivalents on Frame

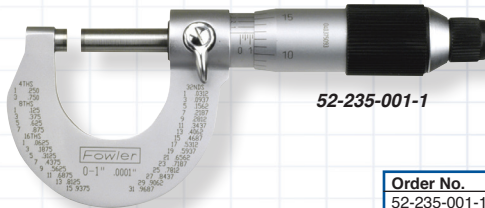

52-235-001-1

- Black decimal equivalents on satin chrome finished forged steel frame
- Graduations: 0.0001"
- Ratchet thimble and locking nut

Order No.	Range	List Price	Sale Price
52-235-001-1	0 - 1"	\$60.70	\$42.00
52-235-002-2	1 - 2"	73.70	51.00
52-235-003-2	2 - 3"	87.81	61.50

Outside Inch Micrometers

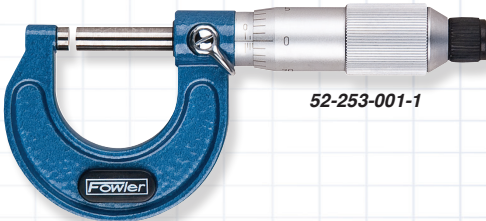

52-253-001-1

- Carbide tipped measuring faces
- Graduation: 0.001"
- Diameter of measuring faces: 0.256"
- Positive locking lever
- Anvil & spindle hardened and precision ground with microlap finish on tips

Order No.	Range	Accuracy	Thimble	List Price	Sale Price
52-253-001-1	0 - 1"	± 0.001"	Friction	\$33.60	\$20.00
52-253-101-1	0 - 1"	± 0.001"	Ratchet	33.60	20.00

Digital Counter Micrometers

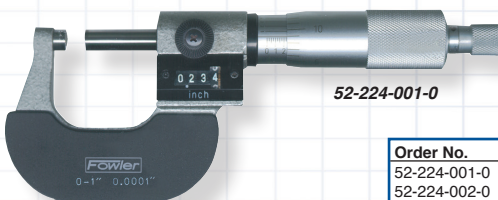

52-224-001-0

- Digital counter reads to 0.001"
- Resolution: 0.0001" (using vernier)
- Microfine graduations on satin chrome
- Carbide tipped measuring faces
- Sizes over 1" include standard

Order No.	Range	List Price	Sale Price
52-224-001-0	0 - 1"	\$109.23	\$70.00
52-224-002-0	1 - 2"	114.84	73.50
52-224-003-0	2 - 3"	130.80	83.70
52-224-004-0	3 - 4"	143.88	92.00



MICROMETERS

XTRA-VALUE II Electronic Micrometers

54-870-001-0

- Resolution: 0.00005"/0.001mm
- Accuracy: $\pm 0.00016"/0.004\text{mm}$ (up to 2")
- Direct RS-232 output
- Carbide measuring faces
- Absolute and incremental modes
- Ratchet thimble



Order No.	Range	List Price	Sale Price
54-870-001-0	0 - 1"/0 - 25mm	\$89.10	\$65.50
54-870-002-0	1 - 2"/25 - 50mm	90.23	67.50
54-870-003-0	2 - 3"/50 - 75mm	105.99	79.30
54-870-004-0	3 - 4"/75 - 100mm	112.48	84.00

Electronic Coolant Resistant Micrometers

54-860-001-1

- Protected to IP54 specifications
- Automatic switch off
- Accuracy: $\pm 0.00016"/0.004\text{mm}$ (up to 2")
- Resolution: 0.00005"/0.001mm
- Direct RS-232 output
- Carbide measuring faces
- Absolute & incremental modes



Order No.	Range	List Price	Sale Price
54-860-001-1	0 - 1"/0 - 25mm	\$112.89	\$89.00
54-860-002-1	1 - 2"/25 - 50mm	130.71	103.00
54-860-003-1	2 - 3"/50 - 75mm	142.55	112.00
54-860-004-1	3 - 4"/75 - 100mm	166.35	131.00
54-860-005-1	4 - 5"/100 - 125mm	185.30	144.50
54-860-006-1	5 - 6"/125 - 150mm	207.96	163.00
54-860-103-1	0 - 3"/0 7-5mm Set	371.32	285.00

Micrometer Stands

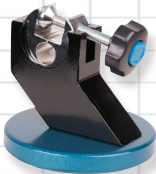

52-247-000-0

- Provides a measuring position and angle for outside micrometers and other instruments.



52-247-005-0

- Unique locking nut adjusts micrometer stand to any position for perfect use and viewing.
- Stand folds for storage.

XTRA MAG



52-247-010-0

Micrometer not included

- Holds standard 0-12" micrometers firmly to metal surfaces
- Use at machine centers, work, assembly and inspection stations, steel tables and shelves
- V-bottom for mounting on cylindrical surfaces
- On/Off magnet switch
- Base is 2.30" L x 1.20" W x 3.50" H

Order No.	Description	List Price	Sale Price
52-247-000-0	Adjustable Micrometer Stand	\$56.90	\$36.50
52-247-005-0	Folding Micrometer Stand	38.08	27.00
52-247-010-0	Magnetic Micrometer Stand	51.00	40.00

Prices & Specifications are subject to change without notice.



MICROMETERS

Rapid-Mic Quick-Displacement Electronic Micrometers



54-815-030-0

**WORLD'S FINEST
Micrometer!**

- Position recall
- IP67 with or without data cable.
- Delrin quick displacement thimble
- Adjustable measuring force, 5N/10N
- Menu customizable with free software **54-815-111-0**
- Non-rotating spindle, 10mm/spindle rotation
- USB output
- Carbide anvils
- Extended Range 0-30mm, 30-66mm and 66-102mm



LIFETIME WARRANTY



IP67

**0-4" Range with
ONLY 3 Mics!**

Order No.	Description	Max Error	List Price	Sale Price
54-815-030-0	0 - 1.18"/0 - 30mm	0.00012"/0.003mm	\$514.79	\$410.00
54-815-060-0	1.18" - 2.6"/30 - 66mm	0.00016"/0.004mm	761.74	695.00
54-815-100-0	2.6" - 4.0"/66 - 102mm	0.00020"/0.005mm	1065.29	945.00
BLUETOOTH MODEL				
54-815-130-0	0 - 1.18"/0 - 30mm	0.00012"/0.003mm	761.74	645.50
Set				
54-815-111-0	0 - 4"/0 - 102mm		2353.34	1995.00
Connectivity Kits				
Order No.	Description			
54-115-526-0	Proximity cable with USB connection		\$136.07	\$122.00
54-115-527-0	Proximity cable with serial connection		136.07	122.00
54-115-246-BT	USB Bluetooth receiver		47.33	42.60

Electronic IP54 Ball Anvil & Spindle Micrometers



54-860-113-1



54-860-211-1

- Ball anvil and spindle for measuring special curved surfaces
- Ball anvil/flat spindle for measuring tubes or the insides of holes to outer edges
- Large LCD display, 8.5mm
- Automatic switch off
- Hardened steel measuring face
- Sizes over 1"/25mm include standard



Order No.	Range	Resolution	Accuracy	List Price	Sale Price
Ball Anvil Micrometers					
54-860-113-1	0 - 1"/0 - 25mm	0.00005"/0.001mm	0.00016"/0.004mm	\$114.40	\$97.20
54-860-114-1	1 - 2"/25 - 50mm	0.00005"/0.001mm	0.00016"/0.004mm	134.00	113.90
54-860-115-1	2 - 3"/50 - 75mm	0.00005"/0.001mm	0.0002"/0.005mm	153.90	130.80
54-860-116-1	3 - 4"/75 - 100mm	0.00005"/0.001mm	0.0002"/0.005mm	173.40	147.30
Ball Anvil & Spindle Micrometers					
54-860-211-1	0 - 1"/0 - 25mm	0.00005"/0.001mm	0.00016"/0.004mm	\$124.70	\$106.00
54-860-212-1	1 - 2"/25 - 50mm	0.00005"/0.001mm	0.00016"/0.004mm	143.90	122.30
54-860-213-1	2 - 3"/50 - 75mm	0.00005"/0.001mm	0.0002"/0.005mm	164.40	139.70
54-860-214-1	3 - 4"/75 - 100mm	0.00005"/0.001mm	0.0002"/0.005mm	185.80	157.90



MICROMETERS SETS

Digit Counter Micrometer Sets

- Digital counter reads to 0.001"
- Resolution: 0.0001" (0.01mm on metric set)
- Carbide tipped measuring faces
- Ratchet thimble

52-224-103-0

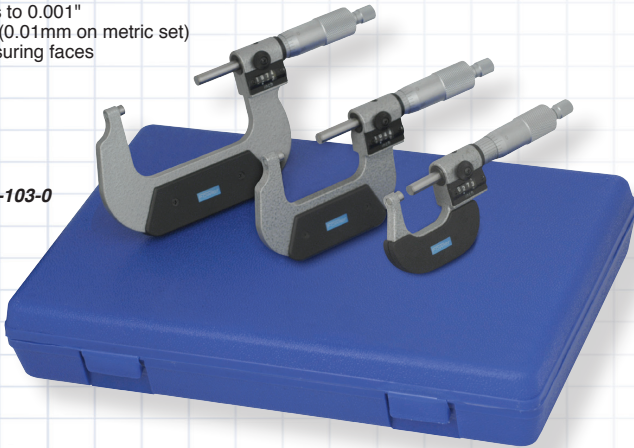

Order No.	Range	List Price	Sale Price
52-224-103-0	0 - 3"	\$363.36	\$232.60
52-224-104-0	0 - 4"	489.36	313.20
52-224-220-0	0 - 75mm	363.36	232.60

Outside Inch Micrometer Sets

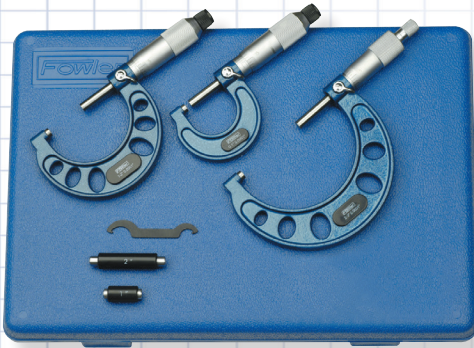

52-215-003-1

- Carbide tipped measuring faces
- Diameter of measuring faces: 0.256"
- Graduation: 0.0001"
- Positive lever locking clamp
- Spindle thread hardened, ground and lapped for ultimate accuracy
- Anvil & spindle hardened and precision ground with microlap finish on tips



52-215-006-1
52-215-012-1 — Includes Wooden Case shown!
52-215-612-1

Order No.	Range	List Price	Sale Price
52-215-003-1	0 - 3" with standards and fitted Shop-Hardened case	\$173.04	\$114.00
52-215-004-1	0 - 4" with standards and fitted Shop-Hardened case	222.21	157.60
52-215-006-1	0 - 6" with standards and fitted Wooden Case	342.38	250.00
52-215-012-1	0 - 12" with standards and fitted Wooden Case	1028.38	616.50
52-215-612-1	6 - 12" with standards and fitted Wooden Case	705.38	419.00

Prices & Specifications are subject to change without notice.

27

Fowler®

TOOL-A-THON Vol. 17.1



Find us on social media!



Fowler-Bowers Bluetooth XTH3 Holematic Pistol Grips

FREE Tablet
with the purchase of
ANY Bluetooth Set!

NEW!



NEW Larger Display!
NEW Ergonomic Design!
NEW Four Presets!

BEST Results in Gage R & R Studies



- Self centering heads
- USB connectivity and Bluetooth
- Fixed anvils
- Resolution: 0.00005" /0.001mm
- To reduce hand fatigue, the travel of the Holematic trigger is adjustable for minimum over travel
- Tungsten carbide measuring faces on all 3-point heads from 0.5" (12.5mm) and up.
- Sizes over 0.500" (12.5mm) feature blind bore capability
- Includes UKAS certificates for all pistol grip, heads and rings
- **Contact the Fowler Technical Department for special anvil applications.**

*Bluetooth sets at Non-Bluetooth set prices

Complete Range Sets

Order No.	Range	Includes	List Price	Sale Price
54-567-009-BT	0.080" - 0.250"/2 - 6mm	5 heads, 1 handle, 3 rings	\$6016.98	\$4750.00
54-567-010-BT	0.250" - 0.375"/6 - 10mm	2 heads, 1 handle, 1 ring	2359.26	1845.00
54-567-020-BT	0.375" - 0.750"/10 - 20mm	3 heads, 1 handle, 2 rings	2760.12	2185.00
54-567-050-BT	0.750" - 2" /20 - 50mm	3 heads, 1 handle, 2 rings	3563.88	2870.00
54-567-100-BT	2 - 4"/50 - 100mm	3 heads, 1 handle, 2 rings	3966.78	3210.00
54-567-105-BT	4 - 6"/100 - 150mm	2 heads, 1 handle, 1 ring	3563.88	2870.00
54-567-110-BT	6 - 8" /150 - 200mm	2 heads, 1 handle, 1 ring	4704.24	3840.00
54-567-200-BT	4 - 8" /100 - 200mm	4 heads, 1 handle, 2 rings	7446.00	6170.00
54-567-210-BT	0.750" - 4" /20 - 100mm	6 heads, 1 handle, 4 rings	5799.72	4770.00
54-567-620-BT	0.250" - 0.750"/ 76 - 20mm	5 heads, 1 handle, 3 rings	3289.50	2635.00

Connectivity Kits

Order No.	Description	List Price	Sale Price
54-115-526-0	Proximity cable with USB connection	\$136.07	\$122.00
54-115-527-0	Proximity cable with serial connection	136.07	122.00
54-115-246-BT	USB bluetooth receiver	47.33	42.60

Fowler-Bowers XT-Series Holemikes



The Fowler-Bowers range of mechanical two and three point bore micrometers are now available as XT extended travel holemikes, allowing a wide measurement range without the need to interchange anvils.

SPECIAL DEAL!

FREE

Free Special Sylvac Ultra Cal IV with Holemike purchase! \$138.00 Value

(features round depth rod)

Features:

- 3-pt contact with tungsten carbide measuring anvils above 0.5"
- Blind bore measuring above 0.5"
- Ratchet stop for consistent measuring
- Extensions available for deep measuring
- Includes UKAS certificates for all Holemikes and setting rings



Order No.	Range	Grads.	Accuracy	Meas. Depth	Ring Included	List Price	Sale Price
52-255-310-0	0.250" - 0.312"	0.00025"	0.00015"	2.28"	0.312"	\$709.21	\$531.00
52-255-311-0	0.312" - 0.375"	0.00025"	0.00015"	2.28"	0.312"	656.68	492.00
52-255-312-0	0.375" - 0.500"	0.00025"	0.00015"	2.28"	0.5"	656.68	492.00
52-255-313-0	0.500" - 0.625"	0.00025"	0.00015"	2.44"	0.5"	656.68	492.00
52-255-314-0	0.625" - 0.750"	0.00025"	0.00015"	2.44"	0.75"	673.40	505.00
52-255-315-0	0.750" - 1"	0.00025"	0.00015"	2.60"	0.75"	739.60	554.00
52-255-316-0	1" - 1.375"	0.00025"	0.00015"	2.60"	1.375"	1053.76	790.00
52-255-317-0	1.375" - 2"	0.00025"	0.00015"	3.15"	1.375"	1078.96	809.00
52-255-318-0	2" - 2.625"	0.00025"	0.0002"	3.15"	2.625"	1287.04	965.00
52-255-319-0	2.625" - 3.250"	0.00025"	0.0002"	3.15"	2.625"	1298.56	973.00
52-255-320-0	3.250" - 4"	0.00025"	0.0002"	3.94"	3.25"	1620.07	1215.00

Fowler-Bowers XT-Series Holemike Sets

Order No.	Range	Includes	List Price	Sale Price
52-255-565-0	0.250" - 0.375"	2 heads, 2 handles, 1 ring	\$1574.88	\$1181.00
52-255-665-0	0.375" - 0.750"	3 heads, 3 handles, 2 rings	1793.36	1345.00
52-255-775-0	0.750" - 2"	3 heads, 3 handles, 2 rings	2817.75	2113.00
52-255-885-0	2" - 4"	3 heads, 3 handles, 2 rings	3820.00	2865.00

Prices & Specifications are subject to change without notice.





DEPTH MICROMETERS

Economy Depth Micrometers

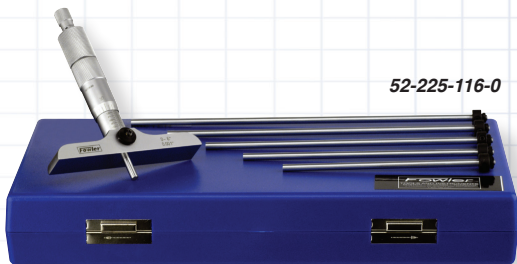

52-225-116-0

- Base surface hardened, ground & lapped
- Ratchet thimble
- Locking clamp
- Rod diameter: 0.176"



Order No.	Range	Graduation	Base	List Price	Sale Price
52-225-110-0	0 - 4"	0.001"	2.5"	\$129.92	\$113.00
52-225-112-0	0 - 6"	0.001"	2.5"	160.83	137.00
52-225-114-0	0 - 4"	0.001"	4"	140.34	122.00
52-225-116-0	0 - 6"	0.001"	4"	164.42	142.00

Digit Counter Depth Micrometers

- Easy-to-read digit counter
- 4" base constructed of tool steel, hardened and ground
- Ratchet thimble
- Locking clamp
- Rod diameter: 0.176"

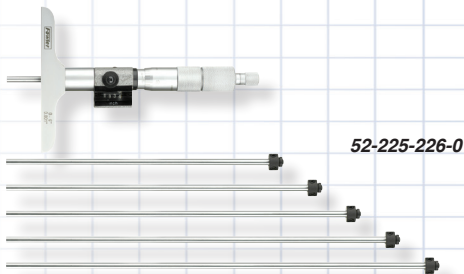

52-225-226-0

Order No.	Range	Graduation	Base	List Price	Sale Price
52-225-176-0	0 - 6"	0.001"	2.5"	\$186.24	\$161.00
52-225-226-0	0 - 6"	0.001"	4"	192.60	167.00

IP54 Electronic Depth Micrometer

- Resolution: 0.00005"/0.001mm
- Range: 0 - 6"/150mm
- Hardened tool steel, precision ground and microlapped 4" base
- Rod diameter: 0.176"
- Large LCD display

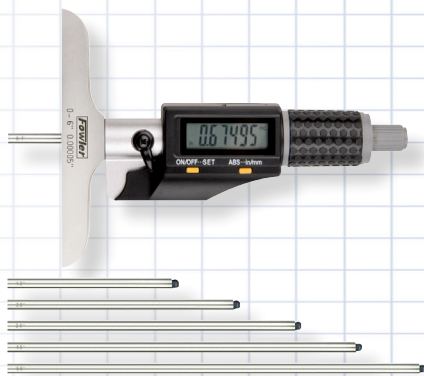

Order No. 54-225-456-0

Sale \$170.00

List \$218.25

INDICATING MICROMETERS

INDI-X® Indicating Micrometers

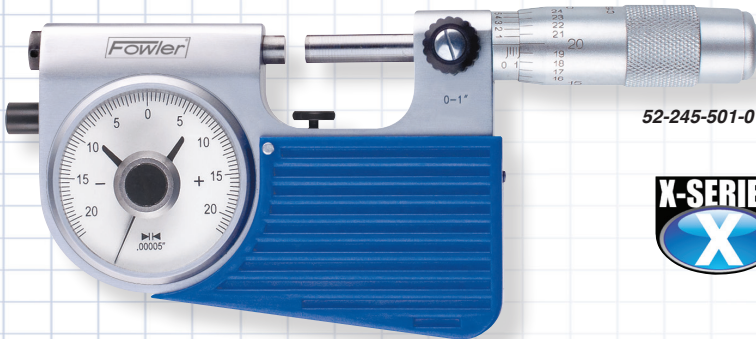

52-245-501-0



- Anvil and spindle hardened and precision ground
- Wider Micro-Fine graduations
- Carbide tipped anvil & spindle
- Retracting button conveniently located in relation to operator's hand
- 0-1" Range, head graduated in 0.001"
- Dial graduated in 0.00005"
- Indicated accuracy of 0.00015"
- Diameter of spindle: 0.256"

Order No.	Description	List Price	Sale Price
52-245-501-0	0-1" Indi-X Indicating Micrometer	\$335.89	\$295.00
52-245-502-0	1-2" Indi-X Indicating Micrometer	389.55	340.00

Electronic Indicating Micrometers

A superior tool in quality and design, the Fowler/Bowers Electronic indicating Micrometer operates quickly and easily.



**SAVE
over \$100**



- Retractable anvil travel: 0.275"(7mm)
- Switchable resolution 0.0005"/0.00005" (0.01/0.001mm)
- Repeatability: 0.00005"(1µm)
- Measuring force 4.5 - 6N
- Adjustable table for parts
- Two reference memories
- Preset Recall function
- Tolerance indication
- Min/Max/TIR function

54-245-777-0

(Stand - 54-245-800-0 not included)

Order No.	Description	List Price	Sale Price
54-245-777-0	0 - 1.25"/0-30mm	\$1208.19	\$1020.00
54-245-780-0	1.25" - 2.50"/30-60mm	1434.12	1200.00

Prices & Specifications are subject to change without notice.

31

Fowler®

TOOL-A-THON Vol. 17.1



Find us on social media!



DEPTH GAGES

X-DEPTH 22® 0-22" Depth Gage



Twice the range of competitive products!

- 0 - 1" travel indicator
- 0.001" Graduations
- Accuracy ± 0.001 "
- Rods connect together for full 22" capacity
- Base size: 4"
- Includes 2 extra points for small hole applications; one 0.078" dia. x 1" long and one needle point x 1" long



Order No. 52-125-006-1

Sale \$135.00

List \$180.66

X-PROOF® 0-22" Dial Depth Gage

with IP54 protection!

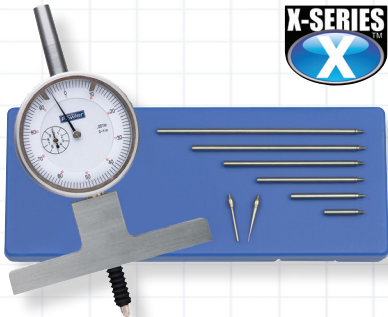

- 0-1" AGD Group 2 IP54 Indicator
- Sealed bezel, top cap and dial with bellows on stem
- Sealed back plate
- Accuracy ± 0.001 "
- 0.001" graduations
- 4" base ground and lapped for flatness
- Rods connect for 22" capacity
- Includes 2 extra points (spline & needle)
- Tolerance markers

Special PRICE

Protected to:
IP54
COOLANT & FLUID
RESISTANT

Order No. 52-125-007-0

Sale \$115.00

List \$196.32

Depth Base Attachment

- Turn your dial or electronic indicator into a depth gage (may reduce range)
- 4" length
- Fits indicators with 3/8" mounting stem
- Ground and lapped base



Order No. 52-125-004-0

Sale \$15.99

List \$38.52

DEPTH GAGES

Light-Line Digital Depth Gages



- Light weight beam made of oxide coated aluminum with double inner prismatic guide ways
- Bases made of hard anodized aluminum
- Includes three base attachments: 150/300/450mm
- Includes two contact points
- Electronics feature on/off, floating zero and direct in/mm conversion
- 0.0005"/0.01mm resolution and repeatability
- Includes a fitted case, instructions, 2 spare base screws, 2 hex wrenches and test certificate.

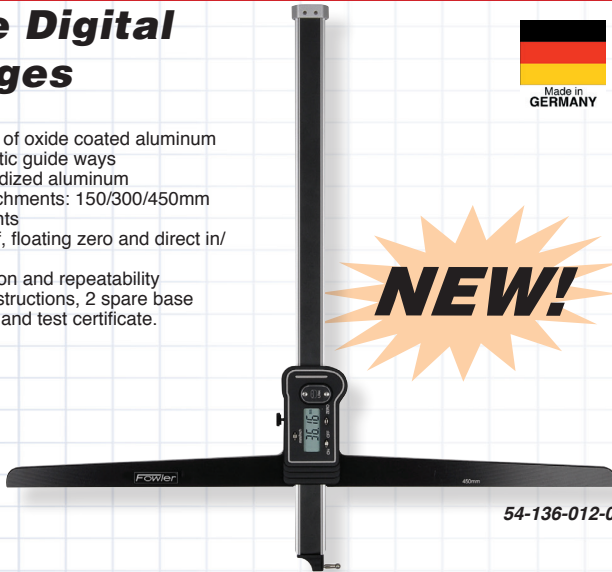

54-136-012-0

Order No.	Range	Accuracy	List Price	Sale Price
54-136-012-0	NEW 0 - 12"/300mm	0.0015"/0.04mm	\$460.00	\$435.00
54-136-030-0	NEW 0 - 31"/800mm	0.0024"/0.06mm	780.00	740.00

Light-Line Digital Depth Gages with adjustable base



- Light weight beam made of oxide coated aluminum
- Bases made of hard anodized aluminum
- Includes 1 base attachment 350mm (14")
- Includes two contact points (1 ball and 1 disk)
- Electronics feature on/off, floating zero and direct in/mm conversion
- 0.0005"/.01mm resolution and repeatability
- Includes fitted case, instructions, 2 base screws, hex wrench and test certificate.

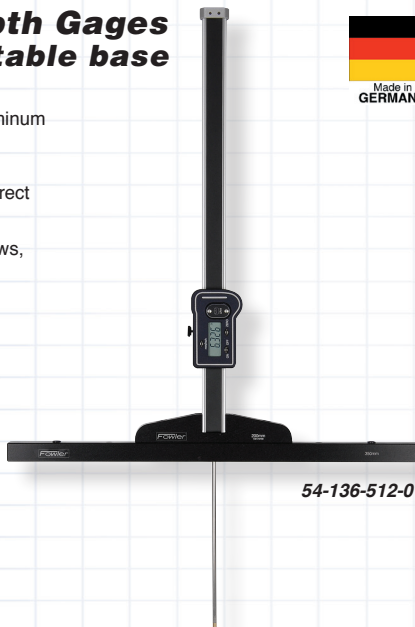

54-136-512-0

Order No.	Range	Accuracy	List Price	Sale Price
54-136-512-0	NEW 0 - 12"/300mm	0.0015"/0.04mm	\$640.00	\$605.00
54-136-535-0	NEW 0 - 31"/800mm	0.0024"/0.06mm	1400.00	1330.00
54-136-621-0	NEW 21"/550mm Base		325.00	307.00
54-136-637-0	NEW 29.5"/750mm Base		480.00	455.00

Prices & Specifications are subject to change without notice.



ID - OD MEASURING

XTRA-VALUE Internal & External Electronic Caliper Gages



54-554-630-0

INCH • METRIC • FRACTION

- Large LCD display
- Reading: 0.01"/0.1mm/1/64ths
- Accuracy: 0.01"/0.3mm/1/64ths
- Spring loaded with locking nut



54-554-730-0

Order No.	Description	Range	List Price	Sale Price
54-554-630	Outside Caliper Gage	0 - 6"/150mm	\$46.97	\$30.00
54-554-730	Inside Caliper Gage	0.5 - 6"/150mm	46.97	30.00

Internal & External Electronic Caliper Gages



54-554-611-0



54-554-711-0

- Large, LCD display
- Resolution: 0.0002"/0.005mm
- Accuracy: $\pm 0.0008"$ ± 0.02 mm
- Preset capability

- Absolute/Incremental measurements
- High-impact, aircraft aluminum case

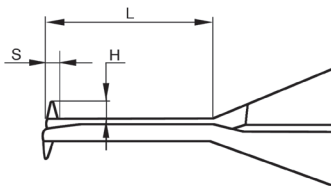

Dimensions for Internal Calipers

Metric	Inch	L	S	H	Tip Radius
5-15mm	0.2-0.6"	20mm	1.0mm	1.5mm	0.3mm
5-25mm	0.2-1.0"	35mm	1mm	1.5mm	0.3mm
10-30mm	0.4-1.2"	55mm	2mm	3.5mm	0.5mm
20-40mm	0.8-1.6"	80mm	3mm	6.5mm	0.5mm
30-50mm	1.2-2.0"	80mm	3mm	8.5mm	0.5mm

Dimensions for External Calipers

Metric	Inch	L	S	H	Tip Radius
0-10mm	0-0.4"	40mm	3mm	8mm	0.5mm
0-20mm	0-0.8"	80mm	6.5mm	25mm	0.75mm
10-30mm	0.4-1.2"	80mm	6.5mm	25mm	0.75mm
20-40mm	0.8-1.6"	80mm	6.5mm	25mm	0.75mm
30-50mm	1.2-2.0"	80mm	6.5mm	25mm	0.75mm

Internal Caliper Gages

Order No.	Range	List Price	Sale Price
54-554-611-0	0.200" - 0.590"/5 - 5mm	\$180.73	\$160.00
54-554-622-0	0.200" - 1"/5 - 25mm	193.87	170.00
54-554-623-0	0.400" - 1.2"/10 - 30mm	202.88	180.00
54-554-624-0	0.790" - 1.6"/20 - 40mm	202.88	180.00
54-554-625-0	1.2" - 2"/30 - 50mm	202.88	180.00

External Caliper Gages

Order No.	Range	List Price	Sale Price
54-554-711-0	0 - 0.400"/0 - 10mm	\$180.73	\$160.00
54-554-722-0	0 - 0.790"/0 - 20mm	193.87	170.00
54-554-723-0	0.4" - 1.2"/10 - 30mm	202.88	180.00
54-554-724-0	0.790" - 1.6"/20 - 40mm	202.88	180.00
54-554-725-0	1.2" - 2"/30 - 50mm	202.88	180.00

INSIDE MICROMETERS

Inside Micrometers

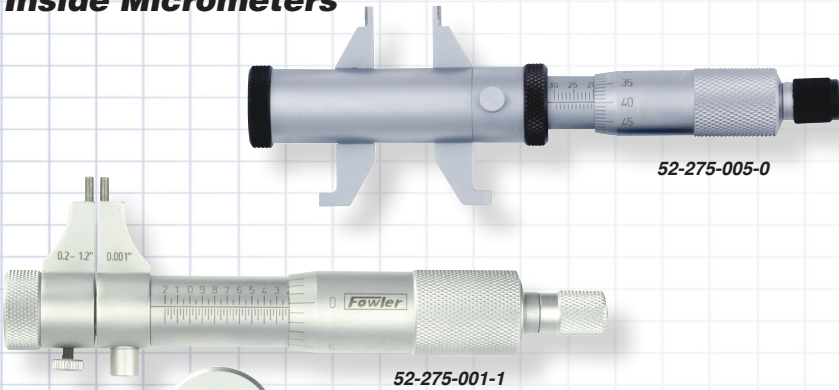

- Measuring faces are fully hardened, precision ground and microlap finished to assure exceptionally accurate measuring
- Spindle threads are hardened and ground
- Microfine graduations 0.001" on a satin chrome finish permit easy reading
- Ratchet stop thimble assures exact and repetitive readings
- Includes a setting ring

Order No.	Range	Graduation	Accuracy	List Price	Sale Price
52-275-001-1	0.2" - 1.2"	0.001"	0.0002"	\$109.32	\$80.00
52-275-002-1	1" - 2"	0.001"	0.0002"	117.72	87.00
52-275-005-0	0.2" - 2.2"	0.001"	0.0002"	184.80	155.00

Electronic IP54 Inside Micrometer



- Each gage includes setting ring.
- Water Resistant to IP54 specifications.
- Resolution: 0.00005"/0.001mm
- Large easy-to-read LCD display
- Friction thimble
- Includes setting ring

Order No.	Range	Accuracy	List Price	Sale Price
54-860-275-0	0.2 - 1.2"	0.00020"/0.005mm	\$231.19	\$170.00
54-860-276-0	1 - 2"	0.00024"/0.006mm	250.58	185.00

Prices & Specifications are subject to change without notice.



CYLINDER BORE GAGES

Dial Bore Gage Sets with Carbide Anvils

Carbide anvils

- Easy-to-read
- Economical
- Insulated grip
- Includes extension holder and fitted case



52-646-100-0



52-646-300-0



Order No.	Range	Graduation	List Price	Sale Price
52-646-100-0	0.7 - 1.5"	0.0005"	\$147.60	\$110.00
52-646-300-0	2 - 6"	0.0005"	121.95	105.00

Extender 1.4" to 6" or 35mm to 160mm Dial Bore Gage Sets with Carbide Anvils

XTENDER

Industry's two most popular bore gage ranges combined in one set!

Carbide Anvils

- Easy-to-read
- Graduation: 0.0005" or 0.01mm
- Insulated grip
- 1.4" to 6" range or 35 to 160mm
- Includes extension holder and fitted case



52-646-400-0



Order No.	Description	Graduation	List Price	Sale Price
52-646-400-0	Inch X-Tender Bore Gage Set	0.0005"	\$185.40	\$110.00
52-646-500-0	Inch X-Tender Bore Gage Set	0.0001"	231.75	173.50
52-646-220-0	Metric X-Tender Bore Gage Set	0.01mm	204.87	120.00

Extender-E Electronic 1.4" to 6" Dial Bore Gage Set

XTENDER-E

Industry's two most popular bore gage ranges combined in one easy-to-use ELECTRONIC set!

Preset size of master for absolute reading and use minimum hold feature to lock on the bore size as the gage is rocked in the part to be measured.



Bore Gage Features:

- Range: 1.4"-6"/35mm-150mm
- Carbide anvils
- Self-centering
- Includes extension holder

Indicator Features:

- Bar graph and numeric digital display
- Resolution: 0.00005"/0.001mm
- Preset with recall
- ABS/INC measurement
- Min/Max/TIR

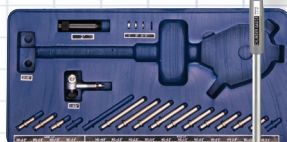

For instructional video search
"X-tender Bore Gage" at www.youtube.com

Order No. 54-646-401-0

Sale \$255.00

List \$320.33



TOOL-A-THON Vol. 17.1
Fowler

CYLINDER BORE GAGES

2" to 6" Right Angle Dial Bore Gage

For measuring difficult-to-reach bores in tight or inconveniently located spaces on machine applications.

- Carbide anvils
- Easy-to-read
- Economical
- Range: 2" to 6"
- Graduation: 0.0005"
- Insulated grip



Order No. 52-646-250-0

Sale \$137.00

List \$274.50

XTRA-RANGE® 4" to 12" Dial Bore Gage

- Carbide Anvils
- 4" to 12" range
- 10" measuring depth
- Easy-to-read
- Economical
- Graduation: 0.0005"
- Insulated grip



Order No. 52-646-600-0

Sale \$140.00

List \$219.80

Prices & Specifications are subject to change without notice.

37

Fowler®

TOOL-A-THON Vol. 17.1



Find us on social media!

INDICATORS

Test Indicators

All Fowler Test Indicators include bi-directional constant clockwise rotation, automatic reversal, three dovetail mountings, jeweled movement, two dovetail clamps and a molded case.



52-562-775-0



52-562-778-0



Extra Points

.040" .120"

Order No.	Face Color	Total Range	Dial Reading	Graduation	Dial Diameter	Point Length	List Price	Sale Price
52-562-774-0	white	0.030"	0-15-0	0.001"	1"	1/2"	\$111.76	\$75.00
52-562-778-0	black	0.030"	0-15-0	0.0005"	1"	1/2"	118.76	75.00
52-562-775-0	white	0.030"	0-15-0	0.0005"	1"	1/2"	118.76	75.00
52-562-776-0	white	0.030"	0-15-0	0.0005"	1-1/2"	1/2"	124.22	75.00
52-562-780-0	black	0.030"	0-15-0	0.0005"	1-1/2"	1/2"	124.22	75.00



52-563-772-0



52-563-777-0

Extra Points

.040" .120"

Order No.	Face Color	Total Range	Dial Reading	Graduation	Dial Diameter	Point Length	List Price	Sale Price
52-563-770-0	white	0.008"	0-4-0	0.0001"	1"	1/2"	\$118.76	\$90.00
52-563-771-0	black	0.008"	0-4-0	0.0001"	1"	1/2"	118.76	90.00
52-563-777-0	white	0.008"	0-4-0	0.0001"	1-1/2"	1/2"	118.76	90.00
52-563-772-0	black	0.008"	0-4-0	0.0001"	1-1/2"	1/2"	118.76	90.00

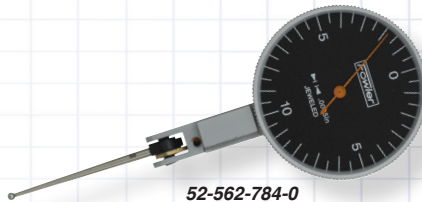

52-562-784-0

Extra Points

.040" .120"

Order No.	Face Color	Total Range	Dial Reading	Graduation	Dial Diameter	Point Length	List Price	Sale Price
52-562-781-0	white	0.020"	0-10-0	0.0005"	1"	1-7/16"	\$122.36	\$95.00
52-562-782-0	black	0.020"	0-10-0	0.0005"	1"	1-7/16"	122.36	95.00
52-562-783-0	white	0.020"	0-10-0	0.0005"	1-1/2"	1-7/16"	122.36	95.00
52-562-784-0	black	0.020"	0-10-0	0.0005"	1-1/2"	1-7/16"	122.36	95.00



INDICATORS

XTEST X-Test Indicators

TWICE the range of most indicators!

- Jeweled movement
- Revolution counter
- Easy-to-read tilted dial
- Automatic reversal
- 210° Swivel arc
- 5/32" stem
- Tungsten carbide point: 0.080"
- Range: 0.060" inch model
- Range: 1.6mm metric model



52-562-001-0

52-562-002-0

TOOL-A-THON
BEST SELLER!
FOWLER HIGH PRECISION

X-SERIES
X

2X
Contact Points
.040" & .120"
w/ purchase

Order No.	Style	Graduations	Dial Diameter	Dial Reading	List Price	Sale Price
52-562-001-0	Horizontal	0.0005"	1-1/2"	0-15-0	\$124.73	\$100.00
52-562-002-0	Horizontal	0.0005"	1"	0-15-0	127.73	100.00
52-562-003-0	Horizontal	0.001"	1"	0-15-0	127.73	100.00
52-562-004-0	Vertical	0.0005"	1-1/2"	0-15-0	136.58	100.00
52-562-005-0	Vertical	0.0005"	1"	0-15-0	136.58	100.00
52-562-006-0	Vertical	0.001"	1"	0-15-0	136.58	100.00
52-562-007-0	Horizontal	0.01mm	25mm	0-40-0	124.94	100.00
52-562-008-0	Horizontal	0.01mm	38mm	0-40-0	124.94	100.00

QuadraTest™ Multimode Electronic Test Indicators

The QuadraTest is the perfect solution to test indicating applications.

- 4 measuring modes: Min, Max, TIR and Direct
- 4 measuring resolutions - 0.00005"/0.001mm or 0.0005"/0.01mm
- Water, oil and coolant resistant to IP65
- 1-1/2" diameter dial face rotates a full 360°
- Bar graph and numeric digital display.
- Meets or exceeds DIN/ISO Standards.
(Maximum error on .00005" scale at full range: 0.0004")
- Available with 1/2" or extra-long 1-7/16" contact point.



54-562-777-0

+
swiss made
Fowler sylvac
Swiss Quality!

Fowler
5
FIVE YEAR WARRANTY

Fowler
RS-232
INTERFACE

Fowler
POWER
INTERFACE

IP65

Order No.	Range	Contact Point Length	List Price	Sale Price
54-562-777-0	0.040"/1mm	1/2"	\$224.91	\$195.00
54-562-888-0	0.020"/0.5mm	1-7/16"	332.01	300.00
Accessories				
54-115-528-0	Output Cable USB		\$231.13	\$218.00

Prices & Specifications are subject to change without notice.

39

Fowler

TOOL-A-THON Vol. 17.1



Find us on social media!
f
e
in
You Tube

INDICATORS

XTRA MAG[®]

A Versatile Universal & Mag Base Combo

Mag Base:

- Microfine adjustment screw
- Dovetail mounting

Test Indicator: (52-562-778-0)

- Range: 0.030"
- Reading: 0-15-0
- Jeweled movement
- Graduation: 0.0005"
- Auto-reversing
- 0.080" diameter point



Virtually unlimited
positioning as a
Universal Base!



52-585-100-0



Order No.	Description	List Price	Sale Price
52-585-105-0	Xtra Mag only	\$54.90	\$35.00
52-585-100-0	Xtra Mag with Test Indicator	164.59	132.50

XTEST X-Test Indicator & Accessory Combo Kits

- X-Test Dial Test Indicator
- Axial support
- Height gage bar with clamp
- Adaptor sleeve: 5/32" to 3/8"



52-562-110-0

Order No.	Description	Graduations	List Price	Sale Price
52-562-100-0	52-562-001-0 w/accessories	0.0005"	\$183.13	\$155.00
52-562-110-0	52-562-002-0 w/accessories	0.0005"	183.13	155.00
52-562-120-0	52-562-003-0 w/accessories	0.001"	183.13	155.00

Test Indicator Set with Certificate of Calibration

Test Indicator:

- Auto-reverse
- Jeweled movement
- Range: 0.030"
- Graduation: 0.0005"
- Dial Reading: 0-15-0
- Dial Diameter: 1.125"
- Point Length: 0.400"
- Carbide contact points

Set Also Includes:

- .080" & .040" contact points
- Universal clamp
- Height gage attachment
- 3/8" & 1/4" dovetail clamps
- Manufacturer's test certificate



Order No. 52-562-999-0

Sale \$110.00

List \$121.28

INDICATORS

Premium Dial Indicators



52-520-135-0

- Tolerance markers
- Solid steel housing
- Carbide contact point



52-520-110-1



52-520-110-2

Calibration Certificate

Part Number: 52-520-110-1 Tool Description: Dial Indicator
 Serial Number: 61015 Range: 1"
 Test Standard: ASME B89 Tool Resolution: .001"
 Temperature: 60°C Humidity: 50%
 Visual Inspection: Pass Function Inspection: Pass

Measurements				
Measure	Nominal Size	+/- Tolerance	+/- Deviation	Pass/Fail
		.001"	0	P
		.001"	0	P
		.002"	0	P
		.002"	0	P
		.002"	0	P
		.002"	0	P
		.002"	+0.01	P
		.070"	+0.01	P
8		.80"	+0.01	P
9		.90"	+0.01	P
10		1.0"	+0.01	P

Reference used: NIST 1013-11-01
 Test Uncertainty: 0.0001"
 Calibration Date: 04-22-2014
 Inspector: [Signature]
 Purchase/Activation: [Signature]

Fowler Precision 66 Howe Street 7466
 Phone: (800) 788-2323 (416) 731-1111

3 year
Warranty

52-520-120-0

Includes NIST Certificate of Calibration

Order No.	Range	Graduation	Reading	Balanced Reading	Dial Color	List Price	Sale Price
52-520-110-1	NEW 1"	0.001"	0 - 100	—	Black Face	\$87.55	\$65.00
52-520-110-2	NEW 1"	0.001"	0 - 100	—	White Face	87.55	65.00
52-520-105-0	NEW 0.500"	0.001"	0 - 100	0 - 50 - 0	White Face	82.81	62.00
52-520-120-0	NEW 2"	0.001"	0 - 100	0 - 50 - 0	White Face	135.45	101.50
52-520-129-0	NEW 1"	0.0005"	0 - 50	0 - 25 - 0	White Face	105.88	79.00
52-520-135-0	NEW 0.05"	0.0001"	0 - 10	0 - 5 - 0	White Face	151.72	113.50
52-520-125-0	NEW 0.250"	0.0005"	0 - 50	0 - 25 - 0	White Face	115.57	86.50
52-520-500-0	NEW 25mm	0.01mm	0 - 100	0 - 50 - 0	White Face	133.28	99.00

X-PROOF® IP54 Shockproof Dial Indicators

Protection Includes:

- Rubber bellows on stem
- O-ring seal on safety cap
- O-ring protection for bezel and rotating dial
- Sealed back plate

Specifications:

- Shockproof design
- Continuous reading: 0-100
- Tolerance markers
- AGD Group 2, 2-1/4" dia.
- Lugback and carbide point



52-520-450-0



52-520-455-0

Order No.	Range	Graduation	Reading	Contact Point	List Price	Sale Price
52-520-450-0	1"	0.001"	0 - 100	4 - 48 (3/8" stem)	\$73.65	\$47.50
52-520-455-0	1"	0.001"	0 - 100	4 - 48 (3/8" stem)	79.62	51.00

Prices & Specifications are subject to change without notice.

Fowler
 TOOL-A-THON Vol. 17.1
 Find us on social media!



INDICATORS

INDI-X^{blue} Electronic Indicators

INCH • METRIC • FRACTION™



54-520-250-0



54-520-260-0

Carbide-tipped point!



- Auto Off feature
- 2-1/4" dial face
- Lugback and 3/8" stem mountings
- Resolution 0.0005"/0.01mm
- Tolerance function
- **Absolute/incremental reading**
- Floating zero

Order No.	Description	List Price	Sale Price
54-520-250-0	1"/25mm Indi-X Blue	\$99.70	\$69.00
54-520-260-0	1"/25mm/64ths Indi-X Blue Inch-Metric-Fraction	102.07	71.00
54-520-255-0	0.5"/12.5mm Indi-X Blue	92.60	61.00

INDI-X[®] Electronic Indicator

- 2-3/8" dial face
- 1"/25mm travel
- Lug Back and 3/8" stem mounting
- Resolution: 0.0005"/.01mm
- Accuracy: ± 0.0012"/.03mm
- Tolerance indicators
- Min/Max measurement
- Carbide-tipped point
- Includes 2 extra points for small hole applications: one 0.078" dia. x 1" long and one needle point x 1" long.



Order No. 54-520-025-1

Sale \$145.00

List \$197.66

Find us on social media!



Fowler[®] TOOL-A-THON Vol. 17.1

INDICATORS

INDI-MAX

Electronic Indicators

- IP54 Coolant & fluid resistant
- Auto Off feature
- 2-1/4" dial face
- 3/8" stem - 4-48 thread
- Resolution: 0.00005"/0.001mm
- Accuracy: 0.00016"/0.004mm (to 1")
- Tolerance indicators
- Absolute/incremental reading
- Lugback supplied on 1/2" model



54-520-310-0



54-520-320-0



Carbide-tipped points!



Order No.	Description	List Price	Sale Price
54-520-305-0	0.5"/12.5mm Indi-Max	\$338.90	\$240.00
54-520-310-0	1"/25mm Indi-Max	380.10	265.00
54-520-320-0	2"/50mm Indi-Ma	493.40	350.00
52-525-605-0	Lugback for 1" and 2" models	16.70	12.25
54-520-399-0	Data cable	152.90	140.00
54-115-100-0	NEW Wireless Transmitter Kit - See Page 20	99.50	89.50

54-520-305-0



Fowler

TOOL-A-THON Vol. 17.1



Find us on social media!



MAGNETIC BASES

HOLDXTEC® Magnetic Base



- Accepts 3/8" indicators
- Dovetail clamp for test indicators
- Features 2 fine adjusts making it a **6-Axis mag base**
- Mag base has 180 lb. pull with on/off switch
- Central locking system

Indicator not included



**Features
Double Fine Adjust**

Order No. 52-585-085-0

Sale \$95.00 List \$156.25

Magnetic Bases

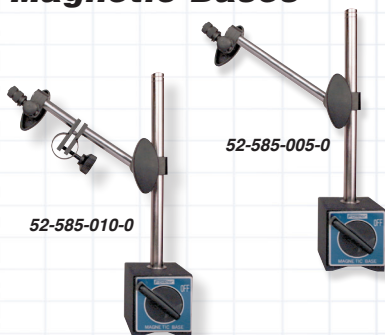

- 9.5" Height and 85 lb. pull
- No. 52-585-010-0 is supplied with fine adjustment clamp for indicators, electronic probes, etc.
- Base dimensions are 2" x 2-11/32" x 1-13/16" (50mm x 58.7mm x 46mm)
- Accepts all AGD dial indicators.
- V-base for placing on round surfaces.
- Mounts test indicators with 1/4" post mount

Order No.	List Price	Sale Price
52-585-005-0	\$47.48	\$35.00
52-585-010-0	55.83	40.00

Hydraulic Arm Magnetic Base

**Adjusts to Virtually
Any Position**



- All purpose magnetic base with 180 lbs. of pulling power.
- Fine adjustment
- Base can be mounted vertically as well as horizontally.
- V-bottom base allows mounting on cylindrical surfaces.

Order No. 52-585-095-0

Sale \$135.00 List \$197.51

Flex Arm Magnetic Bases

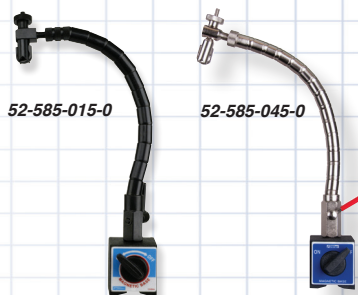

- All purpose magnetic base with 180 lbs. of pulling power
- Base can be mounted vertically as well as horizontally
- V-bottom base allows mounting on cylindrical surfaces
- Adjusts to virtually any position

Chrome Flex Arm Features:

- Corrosion resistant chrome plated flex arm
- 85 lb pull magnetic base

Order No.	List Price	Sale Price
52-585-015-0	\$73.65	\$58.00
52-585-045-0	92.70	73.00

MAGNETIC BASES

Deluxe Dial Gage Stand

- Quick positioning and adjustment
- Fine adjustment of 5/32"
- Holds indicators with stems of 3/8" and 8mm
- Range 5"/125mm
- Working surface of 3-1/2" x 3-1/2"
- Overall Height: 8.5"

Order No. 52-580-015-0

Sale \$255.00

List \$306.29

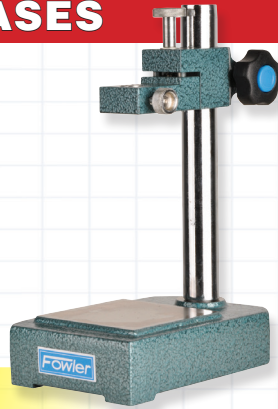

Granite Dial Gage Stand

- Sturdy and compact with extreme stability
- 6" x 6" x 2" granite base
- Positive lock screw
- Fine adjustment knob for zero setting
- Column height is 8"
- Accepts all lug-back indicators
- This stand is maintenance free
- Flatness: 0.00005"

Indicator not included with stand

Order No. 52-580-030-0

Sale \$79.00

List \$116.55



High Precision Dial Gage Stand

- Quick positioning and adjustment
- Features fine adjustment of 5/32"
- Total height of column 14"
- Can hold indicators with stems of 3/8" and 8mm
- Supplied with two 2-3/8" diameter anvils, flat and serrated

Order No. 52-580-014-0

Sale \$155.00

List \$177.94

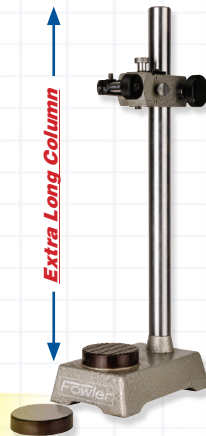

Fowler®

TOOL-A-THON Vol. 17.1



Find us on social media!
f
e
in
You Tube



MAG BASE & INDICATOR COMBOS

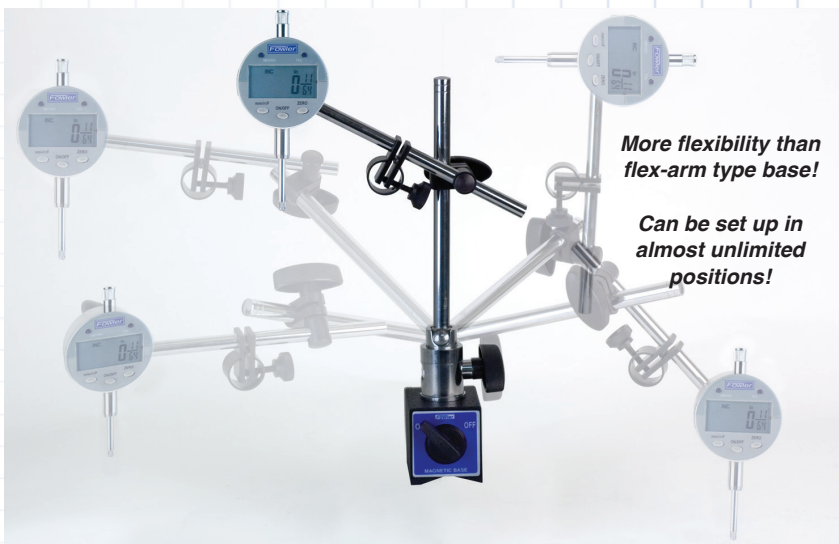

More flexibility than flex-arm type base!

Can be set up in almost unlimited positions!

INCH • METRIC • FRACTION

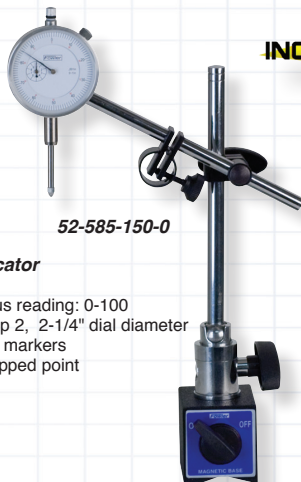

52-585-150-0

AGD Indicator

- 1" travel
- Continuous reading: 0-100
- AGD group 2, 2-1/4" dial diameter
- Tolerance markers
- Carbide tipped point

Artulating Mag Base:

- Fine adjust
- 85 lb. pull
- V-slot on base for mounting on rounded surfaces

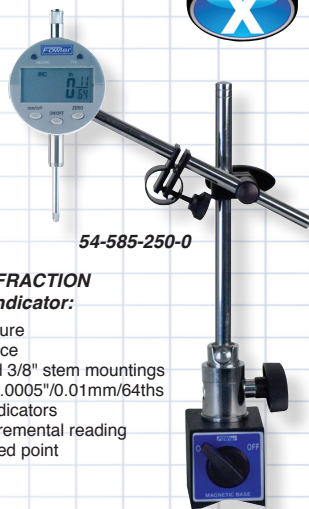

54-585-250-0



Indi-X blue FRACTION Electronic Indicator:

- Auto Off feature
- 2-1/4" dial face
- Lugback and 3/8" stem mountings
- Resolution 0.0005"/0.01mm/64ths
- Tolerance indicators
- Absolute/incremental reading
- Carbide tipped point

Order No.	Description	List Price	Sale Price
52-585-150-0	Artulating Mag Base & AGD Indicator Combo	\$175.00	\$140.00
54-585-250-0	Artulating Mag Base & Indi-X Blue Combo	192.51	155.00
52-520-110-0	AGD Indicator only	68.00	50.00
54-520-260-0	Indi-X Blue Indicator only	102.07	71.00
52-585-008-0	Artulating Mag Base only	94.97	85.00

MAGNETIC BASES

Fine Adjust Mag Base Set



with Indi-X Blue Electronic Indicator

INDI-X^{blue}



Indi-X Blue Indicator:

- 1"/25mm travel
- Auto Off feature
- 2-1/4" dial face
- Lugback and 3/8" stem mountings
- Resolution: 0.0005"/.01mm
- Tolerance indicators
- Absolute/incremental reading
- Carbide tipped point with 4-48 thread

Magnetic Indicator Back:

- Use for positioning the indicator on most metal surfaces.
- Protective coating

Magnetic Base:

- 85 lb. pull
- Fine adjustment
- V-bottom base

Order No. 54-585-075-0

Sale \$155.00
List \$208.27

Fine Adjust Mag Base Set



with AGD White Face Indicator



AGD 2 Indicator:

- Dial diameter: 2-1/4"
- Travel: 1"
- Reading: 0.001"
- Continuous reading: 0.100"
- Carbide tipped point

Magnetic Base:

- 85 lb. pull
- Fine adjustment
- V-bottom base

Magnetic Indicator Back:

- Use for positioning the indicator on most metal surfaces.
- Protective coating

Order No. 52-585-125-0

Sale \$119.00
List \$159.34

Water Resistant Indicator Set



X-PROOF[®]



X-Proof Indicator:

- Travel: 1"
- Reading: 0.001"
- Continuous reading: 0-100
- Tolerance markers
- AGD Group 2, 2-1/4" dia.
- Lugback and carbide point
- Rubber bellows on stem
- O-ring protection for bezel, safety cap, back plate and rotating dial

Magnetic Base:

- Fine adjustment
- Base dimensions: 2" x 2-11/32" x 1-13/16"
- 85 lb. pull
- V-base for placing on round surfaces



Order No. 52-585-155-0

Sale \$68.00
List \$81.78

Chrome FLEX MAG SET[®] with X-PROOF[®] Indicator



X-Proof Indicator:

- Travel: 1"
- Reading: 0.001"
- Continuous reading: 0-100
- Tolerance markers
- AGD Group 2, 2-1/4" dia.
- Lugback and carbide point
- Rubber bellows on stem
- O-ring protection for bezel, safety cap, back plate and rotating dial

Flex Arm Mag Base:

- Corrosion resistant chrome plated flex arm
- 85 lb. pull magnet
- Holds rigidly in almost any position.
- V-base for mounting on rounded surfaces

Magnetic Indicator Back:

- Use for positioning the indicator on most metal surfaces
- Protective coating



Order No.	Set	List Price	Sale Price
52-585-450-0	White Dial	\$190.96	\$150.00
52-585-455-0	Black Dial	196.93	150.00

Prices & Specifications are subject to change without notice.

47

Fowler[®]

TOOL-A-THON Vol. 17.1



Find us on social media!

PROTRACTORS

Mini-Mag Plus

The **NEW** Mini-Mag PLUS Protractor features a USB rechargeable battery, a backlit display, Tilt% function and IP54 protection against water, oil, and fluids.

- IP54 protected against debris and fluids
- USB rechargeable battery with status light (cable included)
- Backlit display
- Tilt % function
- Auto off after 5 minutes
- Embedded magnets
- Measuring range: 360° (4 x 90°)
- Display automatically inverts
- Resolution: 0.05°
- Accuracy: ± 0.2°
- Repeatability: 0.05°
- Hold feature
- Zero function
- Smaller size: 2.12" x 2.12" x .9"
- Light weight: 2.7 oz.



NEW!

Protected to:
IP54
DUST & FLUID
RESISTANT

Order No. 54-422-500-0

Sale \$85.00

List \$105.00

mini-MAG Protractor™

The mini-MAG Protractor provides instant 360° digital inclination display of any angle with the additional unique feature of embedded magnets on both sides and the bottom which make it ideal for a variety of measurements.

- Embedded magnets with 3.5lb. pull
- Uses standard 9V battery (250 hrs.)
- Measuring range: 360° (4 x 90°)
- Display automatically inverts
- Resolution: 0.05°
- Accuracy: ± 0.2°
- Repeatability: 0.05°
- Dimensions 2.375" x 1.375" x 2.375"
- Hold feature



Display inverts for easy reading!

Order No. 54-422-450-1

Sale \$49.99

List \$94.97



Magnetic Dial Protractor

NEW!

Magnets Hold at Any Angle!



- Both flat and "V" mounting with strong built-in magnet
- Punch located at center of "V"
- 1° graduations and accuracy
- Supplied with extra punch

Order No. 52-450-100-0

Sale \$125.00

List \$140.00



MARKING GAGES

Light Line Depth and Marking Gage



Made in GERMANY

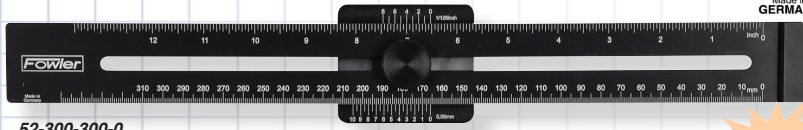

52-300-300-0

- Full aluminum construction, black anodized
- High contrast white numbering
- Positive lock for setting and holding readings
- Available in 8"/200mm and 12"/300mm
- Main body is offset for marking from an edge reference
- Etched in both inch and metric
- Light weight for easy handling

NEW!

Order No.	Range	List Price	Sale Price
52-300-200-0	NEW 8"/200mm	\$24.00	\$22.80
52-300-300-0	NEW 12"/300mm	27.00	25.65

Light Line Marking Protractors



Made in GERMANY

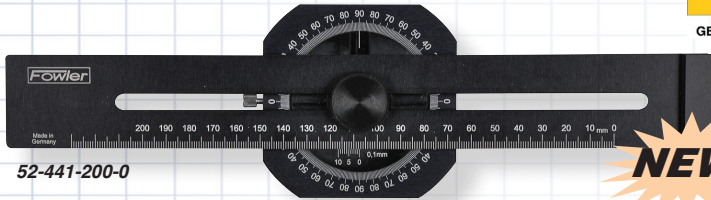

52-441-200-0

- Full aluminum construction, black anodized
- High contrast white numbering
- 2 positive locks for setting and holding readings and angles
- Main body is offset for marking from an edge reference
- Etched in inch graduations and 0-90° in four quadrants
- Graduated in 1° increments and 0.001"
- Light weight for easy handling

NEW!

Order No.	Range	List Price	Sale Price
52-441-200-0	NEW 8"/200mm	\$80.00	\$76.00
52-441-300-0	NEW 12"/300mm	88.00	83.50

Light Line Protractor



Made in GERMANY



52-440-200-0

52-440-300-0

- Light weight for easy handling
- 0-180° range
- Black anodized aluminum construction
- High contrast white numbering
- Positive lock knob for holding position
- Fine tip laser finish for easy reading

NEW!

Order No.	Base x Beam	List Price	Sale Price
52-440-120-0	NEW 5" x 6"	\$20.00	\$18.00
52-440-200-0	NEW 8" x 12"	34.00	31.00
52-440-300-0	NEW 12" x 20"	68.00	63.00

Fowler®

TOOL-A-THON Vol. 17.1



Find us on social media!



SHOP TOOLS

Electronic Edge Finders

- Six equally spaced light ports provide visibility at any angle
- Made in the USA
- Edge finder lights instantly when stylus touches work edge
- Repeatability: 0.0002"
- Works on any conductive metal



54-575-600-0

54-575-625-0

54-575-650-0

Along with light indication, model #54-575-650-0 emits an audible "beep" at time of contact.

Order No.	Stylus	Shank	Audible	Battery	List Price	Sale Price
54-575-600-0	0.200"	1/2"	NO	12 volt	\$33.11	\$25.00
54-575-625-0	0.200"	1/2"	NO	12 volt	116.75	91.00
54-575-650-0	0.400"	3/4"	YES	12 volt	116.75	91.00

Center Finders

Locates Center Easily!

- Easily locates the center of round parts for scribing
- Blade hardened to 48-52 HRC
- Accurate to 0.0012"/0.03mm

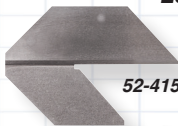

52-415-020-0

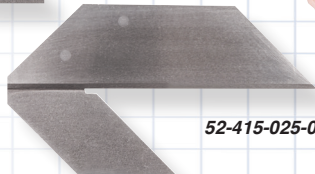

52-415-025-0



Order No.	Description	List Price	Sale Price
52-415-020-0	NEW 1.5" Center Finder	\$17.00	\$15.00
52-415-025-0	NEW 3" Center Finder	19.00	17.00

COAX-2D 2 Dimensional Coaxial Indicator Sets



Use the 2D Coaxial Set for accurate component centering and positioning in most machining applications. The dial remains stationary during the rotation of the machine spindle.

- Indicator assembly with 1.6" (42.5mm) diameter dial
- Graduations and revolution counter 0.0005" (.01mm)
- 3 Internal and 3 External feelers
- Center point feeler
- Restraining arm

Specifications:

- Length: 6-7/8" (175mm)
- Shank: 3/8" dia. x 7/8" (10mm x 20mm) long
- Feeler ball: 1/8" (3mm) dia.
- Dial readings: 0-50
- Measuring range: 0.250" (6mm) axis offset
- Speed—recommended not to exceed approx. 800 RPM
- Repeatability to within 0.0002" (0.005mm) of true center
- Capacity depends on feelers installed, but overall range is 5/32-12" (4-300mm) internal diameter; 0-12" (0-300mm) external diameter



52-710-025-0

Order No.	Description	List Price	Sale Price
52-710-025-0	2D Coaxial Set-Inch	\$238.99	\$160.50
52-710-030-0	2D Coaxial Set-Metric	243.67	173.80

SHOP TOOLS

RULES

EZ-Read Black Face Rules

- Hardened stainless steel
- White easy-to-read micro-fine graduations against a black, non-glare finish



52-297-006-0

52-330-006-0



Golden Rules

- Titanium coated for superior wear resistance
- Non-glare finish=RC80
- Scratch resistant microfine graduations with excellent clarity and contrast

Satin Chrome Rules

- Tempered steel
- Non-glare
- Sharp, easy-to-read microfine graduations

GRADUATIONS
4R: 8ths, 16ths, 32nds, 64ths
16R: 32nds, 64ths, 50ths, 100ths

52-299-006-0



RIGID STEEL RULES

Order No.	Finish	Size	Reading	List Price	Sale Price
52-330-006-0	Satin Chrome	6"	4R	\$11.72	\$10.00
52-337-006-0	Black	6"	4R	9.89	8.40
52-339-006-0	Golden	6"	4R	24.40	20.75
52-330-012-0	Satin Chrome	12"	4R	20.32	17.30
52-337-012-0	Black	12"	4R	20.32	17.30
52-339-012-0	Golden	12"	4R	46.76	39.75
52-350-006-0	Satin Chrome	6"	16R	10.97	9.00
52-338-006-0	Black	6"	16R	9.89	8.20
52-350-012-0	Satin Chrome	12"	16R	18.92	15.50
52-338-012-0	Black	12"	16R	14.84	12.50

FLEXIBLE STEEL RULES

Order No.	Finish	Size	Reading	List Price	Sale Price
52-295-006-0	Satin Chrome	6"	4R	\$11.29	\$9.60
52-297-006-0	Black	6"	4R	9.25	7.85
52-299-006-0	Golden	6"	4R	23.97	20.30
52-295-012-0	Satin Chrome	12"	4R	17.31	15.00
52-297-012-0	Black	12"	4R	14.19	12.50
52-299-012-0	Golden	12"	4R	43.00	36.55
52-308-006-0	Black	6"	16R	9.46	8.00
52-310-006-0	Satin Chrome	6"	16R	11.29	10.00
52-308-012-0	Black	12"	16R	14.19	12.00
52-310-012-0	Satin Chrome	12"	16R	16.56	14.00

Combination Square

- Blades are chrome plated, fully hardened and tempered
- Includes square, protractor and center head with 12" blade
- Square head has level and scribe point
- Double indexed protractor is graduated 180° in both directions
- Graduated in 8ths, 16ths, 32nds and 64ths



TOOL-A-THON
BEST SELLER!
 FOWLER HIGH PRECISION

Order No. 52-370-012-0

Sale \$150.00

List \$200.58

Prices & Specifications are subject to change without notice.

51

Fowler®

TOOL-A-THON Vol. 17.1



Find us on social media!
 f
 e
 in
 You Tube

SHOP TOOLS

Bell Punch

- Easily locates and allows center punching of ends on round stock
- Hardened to 48-52 HRC
- Accurate to 0.0016"/0.04mm

NEW!



Order No.	Description	List Price	Sale Price
52-500-150-0	NEW Bell Punch	\$21.00	\$18.00
52-500-155-0	NEW Replacement punch	4.50	4.00

Premium 1-2-3 Block Set

- Hardened (HRC 55–60)
- 23 holes for easy clamping, 5 tapped, 18 untapped
- Surface finish: 6-16 μ "
- Accuracy: 0.0001"/1"
- Includes hex wrench and 5 mounting bolts (3/8"-16)

Order No. 52-439-032-0

Sale \$72.00

List \$81.50



2-4-6 Blocks

- 23 holes for easy clamping
- Useful in layout & grinding work
- Accuracy: $\pm 0.0002"/1"$
- Matched accuracy: $\pm 0.0002"$

Order No. 52-439-246-0

Sale \$125.00

List \$211.67

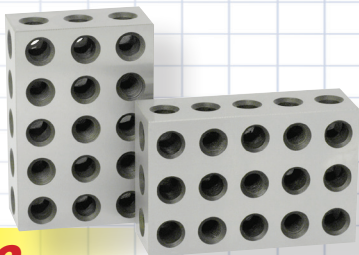

X-BLOX[®] V-Block Set

2 each @:

- Dimensions: 1-1/2" L x 1-1/4" W x 1-1/4" H
- Work capacity: Approximately 1"

2 each @:

- Dimensions: 2" L x 1-1/2" W x 1-1/2" H
- Work capacity: Approximately 1-1/2"
- Surfaces are square and parallel within .0005"
- V-grooves are square and parallel with all surfaces within 0.0005"
- Corresponding dimensions for each pair are alike within 0.0005"



Order No. 52-475-500-0

Sale \$104.00

List \$122.44



SHOP TOOLS

Carbide Super Scriber

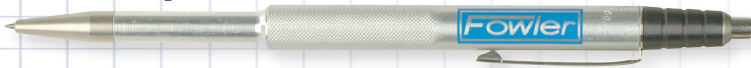

- Lightweight
- Retractable carbide tip
- Knurled grip
- Machined aluminum body
- Pocket clip

Order No.	Description	Overall Length	List Price	Sale Price
52-500-050-0	Carbide Super Scriber	6.5"	\$33.60	\$25.00
52-500-055-0	Carbide Refill		10.29	8.00

Etching Pen



A "must" for any tool room and machine shop for general marking purposes, Fowler's metal etching pen is used on copper, copper alloy, stainless steel, hardened steel tools and castings, etc. Use it to initial personal tools or to restore graduations on rules, height gages, calipers, micrometers, etc. Its low-cost, disposable design offers limitless applications.

Order No. 52-730-005-0

Sale \$14.50 List \$18.26

Thickness Gages

- Each leaf of the thickness gage made of fine tempered steel, hardened
- The exact thickness is marked on each leaf
- Steel case with lock nut
- Meets U.S. Federal Specifications

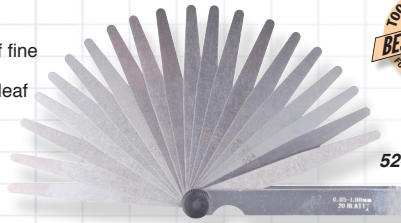

52-485-010-0

Order No.	Description	List Price	Sale Price
52-485-006-0	Tapered Thickness Gages-Inch 26 Leaf Set: 0.0015", 0.002", 0.0025", 0.003", 0.004", 0.005", 0.006", 0.007", 0.008", 0.009", 0.010", 0.011", 0.012", 0.013", 0.014", 0.015", 0.016", 0.017", 0.018", 0.019", 0.020", 0.021", 0.022", 0.023", 0.024" and 0.025". Length: 3"	\$16.56	\$14.25
52-485-010-0	Tapered Thickness Gages-Metric. 20 Leaf Set: 0.05mm, 0.10mm, 0.15mm, 0.20mm, 0.25mm, 0.30mm, 0.35mm, 0.40mm, 0.45mm, 0.50mm, 0.55mm, 0.60mm, 0.65mm, 0.70mm, 0.75mm, 0.80mm, 0.85mm, 0.90mm, 0.95mm and 1mm. Length: 100mm.	18.90	11.00

Screw Pitch Gages

- Narrow designed blades permit use for internal and external screw threads
- Locking device at each end to secure all blades for storage or position
- Correct pitch is determined by matching blade teeth with threads
- Precisely ground and finished
- Blades marked with thread size



52-485-015-0

Order No.	Description	List Price	Sale Price
Inch Series			
52-485-015-0	Screw Pitch Gage with 30 blades: 4 to 42 pitch standard V thread	\$11.34	\$9.50
Metric Series			
52-485-020-0	Screw Pitch Gage with 24 blades: 0.25mm to 6.0mm	11.34	9.50

Prices & Specifications are subject to change without notice.

53

Fowler®

TOOL-A-THON Vol. 17.1



Find us on social media!

f

e

in

YouTube

Find us on social media!

YouTube
LinkedIn
Twitter
Facebook



Fowler® TOOL-A-THON Vol. 17.1

LEVELS

Fowler-Wyler Clinotronic Plus

The Fowler-WYLER Clinotronic Plus is an electronic level with unsurpassed versatility. It is economically priced, uses a specially designed microprocessor and the well-proven WYLER inclination sensor.

Features:

- Range of $\pm 45^\circ$, capacity of 0-360°
- Resolution of 0.01° (selectable)
- Uses standard 1.5v AA batteries
- Absolute or relative measuring mode selectable by push button
- Seal-tec technology for excellent performance even in difficult environmental conditions
- Interface connection RS-232 is integrated. Special purpose cables available
- No loss of calibration data by power failure

Technical Specifications:

- Response time: value available within 5 seconds
- Repeatability: $<.01^\circ$
- Linearity: within 3 min. of arc
- Battery: Standard AA 1.5V alkaline/130hrs or AA 3.0V MnO₂-Lithium (for longer operation 300/hrs)
- Housing: aluminum hard anodized.
- Dimensions: 4 x 3 x 1"(100 x 75 x 30mm)
- Temp. range: operational 0 to 40°C



The following measuring units may be selected:

Deg/Arcmin	00° 00'
Arcmin / Arcsec	00' 00"
GON / Neugrad (2 Dec)	00.00 gon
GON / Neugrad (4 Dec)	.0000 gon
mm / rel.Basis (2 Dec)	00.00 mm/m
mm / rel.Basis (4 Dec)	.0000 mm/m
Inch / rel.Basis (4 Dec)	.0000"/10"
artillery per mille A‰	0000
mm / m (2 Dec)	00.00 mm/m
Inch / 10 Inches	.0000"/10"
Inch / 12 Inches	.0000"/12"
Milliradian	00.00 mrad (2Dec)
Milliradian	0000 mrad
Deg (2 Dec)	00.00 °
Deg (4 Dec)	.0000 °

Order No. 54-635-601-0

Sale \$1750.00 List \$1969.93

Fowler-Wyler Frame Spirit Levels

Sensitivity 0.0005" per 10". The level features two prismatic sides and also comes equipped with insulating handles.

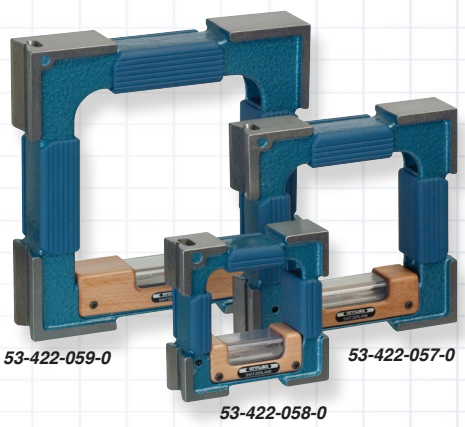

53-422-059-0

53-422-057-0

53-422-058-0

- Ultra high Swiss quality
- Hand scraped by Swiss craftsmen.
- A clear view of the main vial can be observed not only from above, but also from both sides



Order No.	Inch	Metric	Sensitivity Angular	Overall Dimensions	List Price	Sale Price
53-422-057-0	0.0005"/10"	0.05mm/m	10 sec.	6" x 1-3/8" x 6"	\$1622.00	\$1350.00
53-422-058-0	0.0005"/10"	0.05mm/m	10 sec.	4" x 1-3/8" x 4"	1443.50	1200.00
53-422-059-0	0.0005"/10"	0.05mm/m	10 sec.	7-7/8" x 1-9/16" x 7-7/8"	1996.14	1600.00

Scan 52

First horizontal SCAN machine specially designed for workshop measurement close to the machine-tool. The concept is to measure the parts in the same position as they are machined.

Suitable for first-off part, control in process (SPC), sampling or 100% inspection, our Sylvac SCAN 52 machines are set to revolutionize the control in workshop.

NEW!

Includes:

- Instrument according to technical specifications
- 2 male centers
- Computer
- Mouse
- Keyboard
- Windows multilingual operating system
- Screen
- Manual
- Sylvac Reflex-Scan Software
- Rotary headstock (on model 54-902-552-1)

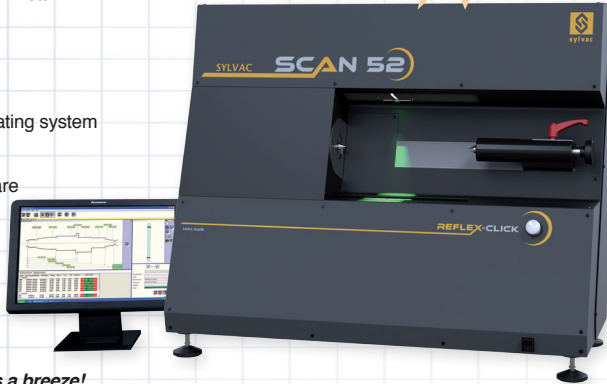

When measuring becomes a breeze!

Place the workpiece on the SCAN machine, click the button and get all the values automatically and without prior programming. Perfectly integrated in the workshop, our SCAN 52 machines replace conventional measuring systems including multi-gauging jigs.



*Reflex Click
The measuring system
that makes everyone
an expert!*

TECHNICAL SPECIFICATIONS

	54-902-552-0		54-902-552-1	
	Diameter	Length	Diameter	Length
Measuring range (mm)	0.5 ÷ 52	300	0.5 ÷ 52	300
Numerical interval (mm)	0.0001	0.0005	0.0001	0.0005
Accuracy μm	(1.5 + D/100)	(4 + L/100)	(1.5 + D/100)	(4 + L/100)
Repeatability μm	0.5	2.5	0.5	2.5
Rotary headstock				√
Weight kg		103		

Other styles, sizes and sensitivities are available upon request.

Order No.	Description	List Price
54-902-552-0	NEW Scan 52 without rotary headstock	\$34,136.34
54-902-552-1	NEW Scan 52 with rotary headstock	39,765.72





HIGH PRECISION
www.fowlerprecision.com