



HIGH PRECISION

TOOL-A-THON[®]



over
25 NEW
items!



Volume 20.2

Valid April 1st - June 30th

www.fowlerprecision.com

Coolant Proof Test Indicators

- IP65 rated for dust and coolant protection
- Includes a **FREE** single jointed holder
- Range: 0.030"
- Reading: 0 - 15 - 0
- Graduations: 0.0005"
- Auto reversing
- Jeweled movement
- 3 dovetail mountings
- Includes 3 contact points, 2 dovetail stems and fitted case



52-562-792-0



Included with Purchase!
Single jointed holder



Order No.	Range	Dial Face Color	List Price	Sale Price
52-562-790-0	1"	White	\$149.50	\$134.60
52-562-791-0	1"	Black	149.50	134.60
52-562-792-0	1-1/2"	White	149.50	134.60

HIGH Accuracy Z-Axis Detectors

Save those expensive carbide end mills!



54-188-140-0



For use in CNC machines and other applications where high accuracy is required!

- IP67 rated for dust and coolant protection
- High accuracy and repeatability, $\pm 0.000039"/0.001\text{mm}$
- Carbide touch surface (0.196"/5mm)
- High precision bearing guide system for long life
- Interchangeable magnetic base
- High visibility LED indicator
- Uses 2, 1.5V batteries (SR44 or LR44)
- Battery life approximately 250 hours (on time)

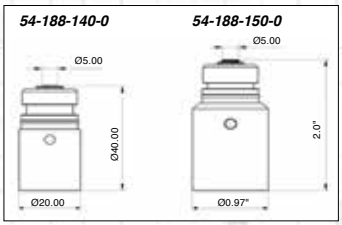

Order No.	Model	Dimensions	List Price	Sale Price
54-188-140-0	Metric	Height: 1.57"/40mm, Dia. 0.78"/20mm	\$267.70	\$240.00
54-188-150-0	Inch	Height: 2"/50.8mm, Dia. 0.97"/24.638mm	267.70	240.00

INDI-X^{blue}

Electronic Indicators

- Accuracy: 0.001"/0.03mm
- Resolution 0.0005"/0.01mm
- 2-1/4" dial face
- Tolerance function for setting specs.
- Absolute/incremental reading
- Lugback and 3/8" stem mountings



INCH • METRIC • FRACTION™



54-520-255-0



54-520-250-0

54-520-260-0



Carbide-tipped point!

Over 27,000 SOLD!

Order No.	Range		Sale Price
54-520-255-0	0.50"/12.5mm Indi-X Blue	Compare to Mitutoyo 543-783 @ \$143.57	\$83.40
54-520-250-0	1"/25mm Indi-X Blue		\$89.70
54-520-260-0	1"/25mm/64ths Indi-X Blue Inch-Metric-Fraction		102.50

INDI-MAX

Electronic Indicators

- IP54 coolant and fluid resistant
- Accuracy: 0.00016"/0.004mm (to 1")
- Resolution 0.00005"/0.001mm
- 2-1/4" dial face
- Tolerance indicators for setting specs.
- Absolute/incremental reading
- 3/8" stem - 4-48 thread
- Auto Off feature
- Lugback on 0.5" model included



54-520-305-0



54-520-310-0



Carbide-tipped points!

54-520-320-0

Order No.	Range		Sale Price
54-520-305-0	0.5"/12.5mm Indi-Max		\$304.90
54-520-310-0	1"/25mm Indi-Max	Compare to Mitutoyo 543-476B @ \$378.49	342.00
54-520-320-0	2"/50mm Indi-Max		499.40
Accessories			
52-525-605-0	Lugback for 1" and 2" models		\$15.00
54-520-399-0	SPC cable (USB)		137.60

Prices & Specifications are subject to change without notice.

Fowler

TOOL-A-THON®

2020



Find us on social media!

Indicator Base Attachments

for measuring depths, steps, recesses etc.

- Turn your dial or electronic indicator into a depth gage (may reduce range)
- 4" length
- Fits indicators with 3/8" and 8mm mounting stems
- Ground and lapped base
- 52-125-005-0 has 0.430" radius



52-125-004-0

Includes 4 extension points!

Order No.	Description	List Price	Sale Price
52-125-004-0	Flat depth base attachment	\$41.30	\$37.20
52-125-005-0	Radius style depth base attachment	41.30	37.20

Indicator Chucks for finer applications



52-526-020-0

- Low carbon steel, black oxide finished
- 0.0140" - 0.040" chucking capacity
- Can be used with small pin gages for special or restricted applications
- Available in both 4-48 and M2.5 threads



Indicator shown not included



Order No.	Description	List Price	Sale Price
52-526-020-0	Indicator Chuck with 4 - 48 thread	\$24.20	\$21.80
52-526-021-0	Indicator Chuck with M2.5 thread	24.20	21.80

Indicator Magnetic Base

with Fine Adjustment

- 85 lb pull magnetic base
- V-bottom base allows mounting on cylindrical surfaces
- On/off lever releases magnet
- Base dimensions 2-1/2" x 2-1/8" x 2" (63.5mm x 54mm x 50mm)
- Mounts test indicators with 1/4" post mount and AGD indicators
- Use with milling machines, lathes, etc.



Order No. 52-585-020-0

Sale \$58.²⁰

List \$72.70

Flex Arm Indicator Magnetic Base

- Corrosion resistant chrome plated flex arm
- 85 lb pull magnetic base
- On/off lever releases magnet
- Base can be mounted vertically as well as horizontally
- V-bottom base allows mounting on cylindrical surfaces
- Base dimensions 2-1/2" x 2-1/8" x 2" (63.5mm x 54mm x 50mm)
- Adjusts to virtually any position

Order No. 52-585-045-0

Sale \$83.⁵⁰

List \$104.30



High Precision Dial Gage Stand

Fowler's High Precision Dial Gage Stand is 10" in overall height with a precision serrated anvil

- Quick positioning and adjustment
- Zero settings with fine adjustment
- Fine adjustment range of 5/32"
- Total height of column 8"
- Dial gage stand holds indicators with stems of 3/8" and 8mm
- 2" Serrated anvil

Order No. 52-580-011-0

Sale \$185.⁷⁰

List \$232.10



Granite Dial Gage Stand

Fowler's Workshop Black Granite Stand is ideal for shop-floor use!

- Flatness: 0.00005"
- Sturdy and compact with extreme stability.
- 6" x 6" x 2" granite base
- Positive lock screw
- Fine adjustment knob for zero setting of gages
- Column height is 8"
- Accepts all lug-back indicators

Indicator not included with stand

Order No. 52-580-030-0

Sale \$100.⁰⁰

List \$125.00



Fowler

TOOL-A-THON®

2020



Find us on social media!

LIFETIME WARRANTY



We are so confident that these Fowler-Sylvac Mark VI electronic indicators are the most accurate, most dependable, best made products you can buy, we are extending the warranty to last a lifetime!

Mark VI Electronic Indicators

- Extremely accurate
- Robust construction
- Repeatability: 0.00008"/2µm
- Output: Proximity/Power - USB/RS232/digimatic/Wireless
- Menus customizable with free software
- Wide range of functions (MIN/MAX/DELTA, TOL, Factor, Preset, Auto Off, etc)
- Bezel rotates 270°
- Large display with LED tolerance indicators
- Includes lug back



Contact the Fowler Sales Department
1-800-788-2353



54-530-535-0



Order No.	Description	Maximum Error	Resolution	List Price	Sale Price
54-530-125-0	0 - 0.500"/12.5mm	0.0004"/0.01mm	0.0005"/0.01mm	\$452.70	\$407.50
54-530-135-0	0 - 0.500"/12.5mm	0.00012"/0.003mm	0.00005"/0.001mm	579.60	\$21.70
54-530-145-0	0 - 1"/25mm	0.0004"/0.01mm	0.0005"/0.01mm	516.70	\$65.10
54-530-155-0	0 - 1"/25mm	0.00016"/0.004mm	0.00005"/0.001mm	618.30	\$56.50
54-530-155-C	0 - 1"/25mm with ISO/A2LA Certification				\$57.60
54-530-175-0	0 - 2"/50mm	0.00019"/0.005mm	0.00005"/0.001mm	1170.30	\$1053.30
Bluetooth					
54-530-335-0	0 - 0.500"/12.5mm	0.00012"/0.003mm	0.00005"/0.001mm	\$717.60	\$645.90
54-530-355-0	0 - 1"/25mm	0.00016"/0.004mm	0.00005"/0.001mm	767.40	\$690.70
Analog Display					
54-530-535-0	0 - 0.500"/12.5mm	0.00012"/0.003mm	0.00005"/0.001mm	\$651.40	\$521.20
54-530-555-0	0 - 1.00"/25mm	0.00016"/0.004mm	0.00005"/0.001mm	712.20	\$69.80
Accessory					
54-115-246-BT	USB Bluetooth Receiver			\$50.80	\$45.80

Premium Dial Indicators

- Tolerance markers
- Solid steel housing
- Carbide contact point



52-520-135-0



52-520-110-1



52-520-110-2

"Great price for a great indicator" V.C.



3 Year Warranty

Includes NIST Certificate of Calibration

Order No.	Range	Graduation	Reading	Balanced Reading	Dial Color	Sale Price
52-520-110-1	1"	0.001"	0 - 100	—	Black	Compare to Mitutoyo 2904S @ \$113.60 \$75.20
52-520-110-2	1"	0.001"	0 - 100	—	White	Compare to Mitutoyo 2904S @ \$113.60 75.20
52-520-115-0	1"	0.001"	—	0 - 50 - 0	White	89.90
52-520-125-0	0.250"	0.0005"	0 - 50	0 - 25 - 0	White	99.20
52-520-129-0	1"	0.0005"	0 - 50	0 - 25 - 0	White	90.80
52-520-135-0	0.05"	0.0001"	0 - 10	0 - 5 - 0	White	130.20
52-520-300-0	10mm	0.01mm	0 - 100	0 - 50 - 0	White	85.80
52-520-500-0	25mm	0.01mm	0 - 100	0 - 50 - 0	White	114.40

DUAL PLUS+ Dial Indicator

- Two dial indicators in one
- Inch on one side and metric on the opposite side
- Range: 0.5"/12.5mm
- Graduation: 0.001"/0.01mm
- 8mm mounting stem with 3/8" adapter bushing included
- Jeweled movements
- Carbide contact point
- 1" spline contact point included for fine applications
- Includes NIST certificate for both inch and metric readings



Order No. 52-530-115-0

Sale \$82.00

List \$110.40

Fowler TOOL-A-THON® 2020

Find us on social media!



QuadraTest™

Multimode Electronic Test Indicators

The QuadraTest is the perfect solution to test indicating applications

- Meets or exceeds DIN/ISO Standards (Maximum error on 0.00005" scale at full range: 0.0004")
- 4 measuring modes: Min, Max, TIR and Direct
- 4 measuring resolutions - 0.00005"/0.001mm or 0.0005"/0.01mm
- Water, oil and coolant resistant to IP65
- 1-1/2" diameter dial face rotates a full 360°
- Bar graph and numeric digital display
- Available with 1/2" or extra-long 1-7/16" contact point



54-562-777-0

Order No.	Range	Contact Point Length	List Price	Sale Price
54-562-777-0	0.040"/1mm	1/2"	\$358.60	\$330.00
54-562-888-0	0.020"/0.5mm	1-7/16"	388.90	360.00
Accessory				
54-115-528-0	Output Cable USB		\$242.90	\$218.70

Height Transfer and Squareness Gage

A perfect match for **QuadraTest™** Indicators!

- Used for a variety of surface plate applications
- Large fine adjustment knob for precise control
- Swivel clamp anchors swivel and indicator for added accuracy
- Rear surface of the gage has a reference surface to place against a master for checking squareness
- Includes a 7.5" post, indicator rod and clamp



Indicator and standard shown not included

Order No. 53-620-010-0

Sale \$272.70

List \$340.80

Any Indicator on this page \$110.00

Test Indicators

All Fowler Test Indicators include bi-directional constant clockwise rotation, automatic reversal, three dovetail mountings, jeweled movement, two dovetail clamps and a molded case.



Extra Points

.040" .120"



52-562-775-0



52-562-778-0

0.001"
0.0005"
Reading

Order No.	Face Color	Total Range	Dial Reading	Graduation	Dial Diameter	Point Length	List Price	Sale Price
52-562-774-0	white	0.030"	0-15-0	0.001"	1"	1/2"	\$125.70	\$110.00
52-562-778-0	black	0.030"	0-15-0	0.0005"	1"	1/2"	133.60	110.00
52-562-775-0	white	0.030"	0-15-0	0.0005"	1"	1/2"	133.60	110.00
52-562-776-0	white	0.030"	0-15-0	0.0005"	1-1/2"	1/2"	139.70	110.00
52-562-780-0	black	0.030"	0-15-0	0.0005"	1-1/2"	1/2"	139.70	110.00

Extra Points

.040" .120"



52-563-770-0



52-563-771-0

0.0001"
Reading

Order No.	Face Color	Total Range	Dial Reading	Graduation	Dial Diameter	Point Length	List Price	Sale Price
52-563-770-0	white	0.008"	0-4-0	0.0001"	1"	1/2"	\$133.60	\$110.00
52-563-771-0	black	0.008"	0-4-0	0.0001"	1"	1/2"	133.60	110.00
52-563-772-0	black	0.008"	0-4-0	0.0001"	1-1/2"	1/2"	133.60	110.00
52-563-777-0	white	0.008"	0-4-0	0.0001"	1-1/2"	1/2"	133.60	110.00

Extra Points

.040" .120"



52-562-782-0

Extra Long Contact

Order No.	Face Color	Total Range	Dial Reading	Graduation	Dial Diameter	Point Length	List Price	Sale Price
52-562-782-0	black	0.020"	0-10-0	0.0005"	1"	1-7/16"	\$137.60	\$110.00
52-562-783-0	white	0.020"	0-10-0	0.0005"	1-1/2"	1-7/16"	137.60	110.00

Extra Points

.040" .120"



0.01mm
Reading

Order No.	Face Color	Total Range	Dial Reading	Graduation	Dial Diameter	Point Length	List Price	Sale Price
52-563-677-0	white	0.08mm	0-40-0	0.01mm	1-1/4"	1/2"	\$137.60	\$110.00

Prices & Specifications are subject to change without notice.

X-TEST® Horizontal Indicators

NOW available with High Contrast Black Dial Face!

- Solid brass anti-magnetic housing
- Super smooth jeweled movement
- Smooth bezel adjustment for easy zero setting
- 0.080" and 0.120" carbide ball contact points (0.040" steel ball)
- 0.060" range with auto reverse and rev. counter
- Easy to read tilted dial
- 5/32" pivotable stem



52-562-002-BF

Includes NIST Certificate of Calibration

Order No.	Graduation	Dial Size	Dial Reading		Sale Price
52-562-001-BF	0.0005"	1-1/2"	0 - 15 - 0	Compare to Brown & Sharpe 74.111370 @ \$229.01	\$120.40
52-562-002-BF	0.0005"	1"	0 - 15 - 0		120.40

XTEST Horizontal Indicators

- Solid brass anti-magnetic housing
- Super smooth jeweled movement
- Smooth bezel adjustment for easy zero setting
- 0.080" and 0.120" carbide ball contact points (0.040" steel ball)
- 0.060" range with auto reverse and rev. counter
- Easy to read tilted dial
- 5/32" pivotable stem



52-562-001-0

52-562-002-0

Includes NIST Certificate of Calibration

Order No.	Graduations	Dial Diameter	Dial Reading		Sale Price
52-562-001-0	0.0005"	1-1/2"	0-15-0	Compare to Brown & Sharpe 74.111370 @ \$229.01	\$120.40
52-562-002-0	0.0005"	1"	0-15-0	Compare to Brown & Sharpe 74.111370 @ \$229.01	120.40
52-562-007-0	0.01mm	25mm	0-40-0		120.40
52-562-008-0	0.01mm	38mm	0-40-0		120.40

XTEST Vertical Indicators

TWICE the range of most indicators!

- Solid brass anti-magnetic housing
- Smooth bezel adjustment for easy zero setting
- 0.080" and 0.120" carbide ball contact points (0.040" steel ball)
- 0.060" range with auto reverse and rev. counter
- 5/32" pivotable stem



52-562-005-0

Includes NIST Certificate of Calibration



Order No.	Graduations	Dial Diameter	Dial Reading	List Price	Sale Price
52-562-004-0	0.0005"	1-1/2"	0-15-0	\$146.40	\$131.80
52-562-005-0	0.0005"	1"	0-15-0	146.40	131.80
52-562-006-0	0.001"	1"	0-15-0	146.40	131.80

X-TEST X-Test Indicator & Accessory Combo Kits

52-562-110-0

Each Combo Kit Includes:

- X-Test Dial Test Indicator (page 9)
- Axial support
- Height gage bar with clamp
- Adaptor sleeve: 5/32" to 3/8"
- Contact point case
- Contact point wrench
- Complete in "Shop Hardened" case



Order No.	Description	Graduations	List Price	Sale Price
52-562-100-0	52-562-001-0 w/accessories	0.0005"	\$196.30	\$170.00
52-562-110-0	52-562-002-0 w/accessories	0.0005"	196.30	170.00
52-562-120-0	52-562-003-0 w/accessories	0.001"	196.30	170.00

Test Indicator Set with Certificate of Calibration

Test Indicator:

- Auto-reverse
- Jeweled movement
- Range: 0.030"
- Graduation: 0.0005"
- Dial Reading: 0-15-0
- Dial Diameter: 1.125"
- Point length: 0.400"
- Carbide contact points, 0.080" and 0.040"

Set Also Includes:

- Universal clamp
- Height gage attachment
- 3/8" & 1/4" dovetail clamps

- Manufacturer's test certificate
- Meets ANSI Specs for accuracy
- All in a fitted molded case



Order No. 52-562-999-0

Sale \$131.00

List \$146.60

Indi-All Test Holder

Fowler's Indi-all indicator holder finds the center position without removing the tool from the machine. It mounts with a single set screw directly on the machine quill, bypassing the working tool. Use for milling machines, jigborers and Bridgeport mills (J-head).

- Clamping dia. 1-7/8"; 3 point adjustment
- Accepts all indicators with 5/32" shank or dovetail. Reach from 0-12" diameter
- Provides readings accurately and quickly without disturbing the workpiece
- Arm length from clamp 4-1/2"



Order No. 52-566-853-0

Sale \$58.80

List \$73.50

Fowler

TOOL-A-THON®

2020



Find us on social media!

TOOL-A-THON® Check us out! For Instructional and Training videos, subscribe to FowlerVid



Bluetooth Ultra-Cal VI Electronic Calipers



54-100-167-0

- IP67 rated
- Available with or without Bluetooth
- Heavy duty frame
- Extra large display
- NOW available with ISO Cert
- 12"/300mm is supplied without depth rod



Order No.	Description	Accuracy	Resolution	Sale Price
Without Data Output				
54-100-177-0	6"/150mm	0.0008"/20µm	0.0005"/0.01mm	<i>Compare to Mitutoyo 500-196-30 @ \$115.00</i> \$108.90
54-100-178-0	8"/200mm	0.0012"/30µm	0.0005"/0.01mm	220.10
54-100-179-0	12"/300mm	0.0012"/30µm	0.0005"/0.01mm	298.00
Bluetooth				
54-100-167-0	6"/150mm	0.0008"/20µm	0.0005"/0.01mm	\$313.20
54-100-167-C	6"/150mm <i>with ISO/A2LA Certification</i>			327.30
54-100-168-0	8"/200mm	0.0012"/30µm	0.0005"/0.01mm	581.40
54-100-169-0	12"/300mm	0.0012"/30µm	0.0005"/0.01mm	774.60
Accessory				
54-115-246-BT	USB bluetooth receiver			\$45.80

Ultra-Cal VI Proximity Electronic Calipers



54-100-444-1

- IP67 rated
- Ultra-Cal VI technology with proximity cable data output
- Heavy duty frame
- Extra large display
- 12"/300mm is supplied without depth rod



Order No.	Description	Accuracy	Resolution	Sale Price
54-100-444-1	6"/150mm	0.0008"/20µm	0.0005"/0.01mm	<i>Compare to Mitutoyo 500-171-30 @ \$159.95</i> \$146.70
54-100-448-1	8"/200mm	0.0012"/30µm	0.0005"/0.01mm	264.90
54-100-412-1	12"/300mm	0.0012"/30µm	0.0005"/0.01mm	354.70
Connectivity Cables				
54-115-526-0	Proximity cable with USB connection			\$135.00
54-155-527-0	Proximity cable with serial connection			135.00

IP67

PLUS+

Electronic Calipers

with Smart Wireless Communication



54-100-556-BT

IP67

IP67 & Smart Wireless All in one!



- **NEW** HID Interface allows connection to most bluetooth enabled devices
- Includes an extra battery tray and a 1" setting standard
- Supplied with NIST certification
- Resolution: 0.0005"/0.01mm
- Absolute/Incremental measurement
- Heavy duty frame with 4 way measuring
- Super large display

Order No.	Range	Accuracy		Sale Price
54-100-554-BT	0 - 4"/100mm	0.001"/0.02mm	Compare to Mitutoyo 500-762-20 @ \$233.01	\$145.50
54-100-556-BT	0 - 6"/150mm	0.001"/0.02mm		149.60
54-100-558-BT	0 - 8"/200mm	0.0015"/0.04mm		181.90

EURO-CAL IV[®] Electronic Calipers



54-100-330-1



INCH • METRIC • FRACTION[™]



54-100-332-0

- Resolution: 0.0005"/0.01mm (Fractions in 1/64" increments)
- Absolute/Incremental measurement
- Stainless steel frame
- 4-way measuring

Order No.	Range	Accuracy	List Price	Sale Price
54-100-330-1	6"/150mm	± 0.001"/0.02mm	\$133.60	\$120.00
54-100-331-0	8"/200mm	± 0.001"/0.02mm	158.10	126.50
54-100-332-0	12"/300mm	± 0.0015"/0.03mm	202.80	182.60

Prices & Specifications are subject to change without notice.

13

Fowler

TOOL-A-THON[®]

2020



Find us on social media!

Digital Calipers

Absolute Reading!



54-100-004-2



54-100-000-2



- Resolution: 0.0005"/0.01mm
- Absolute/Incremental Measurement
- Stainless steel frame
- Direct Inch/Metric conversion
- Large easy-to-read LCD display
- Absolute referencing
- Includes case

Order No.	Range	Accuracy		Sale Price
54-100-004-2	0 - 4"/100mm	0.001"/0.02mm		\$101.10
54-100-000-2	0 - 6"/150mm	0.001"/0.02mm	Compare to Mitutoyo 500-196-30 @ \$141.40	117.90
54-100-008-2	0 - 8"/200mm	0.0015"/0.04mm		138.40
54-100-112-2	0 - 12"/300mm	0.0015"/0.04mm		180.40
Accessory				
54-115-100-0	Wireless transmitter			100.00
54-520-399-0	SPC cable (USB)			137.60

Water Resistant IP54 Electronic Calipers

Absolute Reading!

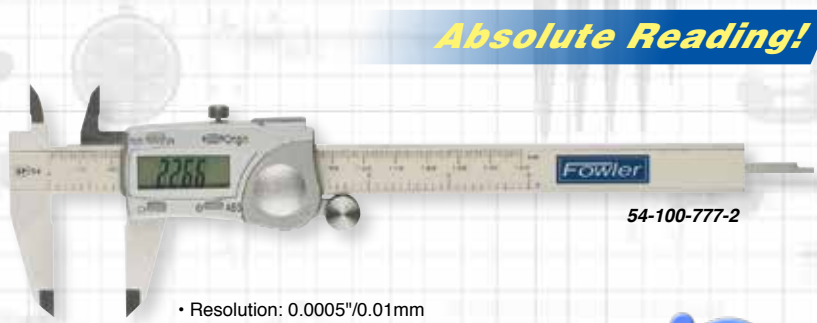

54-100-777-2

- Resolution: 0.0005"/0.01mm
- Absolute/Incremental Measurement
- Stainless steel frame
- Direct Inch/Metric conversion
- Large easy-to-read LCD display
- Absolute referencing
- Includes case



Order No.	Range	Accuracy	List Price	Sale Price
54-100-777-2	0 - 6"/150mm	0.0015"/0.04mm	\$147.00	\$132.30
54-100-712-2	0 - 12"/300mm	0.0015"/0.04mm	213.80	171.10
Accessory				
54-115-100-0	Wireless Transmitter		\$111.90	\$100.00
54-520-399-0	SPC cable (USB)		172.00	137.60

XTRA-VALUE *Plus*

6"/150mm Electronic Caliper

INCH • METRIC • FRACTION™

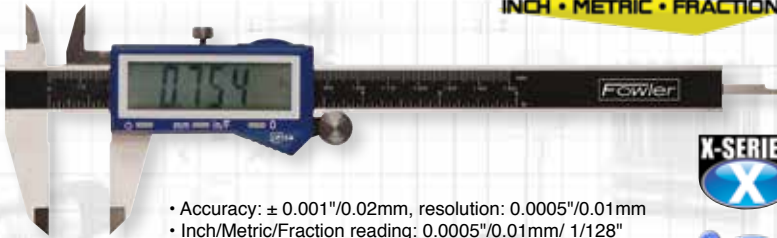

- Accuracy: $\pm 0.001"/0.02\text{mm}$, resolution: $0.0005"/0.01\text{mm}$
- Inch/Metric/Fraction reading: $0.0005"/0.01\text{mm}/ 1/128"$
- Dust, water and oil resistant to IP54 standards making it **great for shop environments**
- Heavy Duty frame for extra rigidity and wear resistance
- Super large, easy to read 14 x 52mm display
- Combined thumbrest and thumbroll for fine adjustment



Order No. 54-103-006-0

Sale \$72.00

List \$80.00

XTRA-VALUE CAL

Electronic Calipers



54-101-300-1

"Great price,
good quality, prompt
processing"

Terri F.

54-101-150-2

- Accuracy: $0.001"/0.02\text{mm}$ (6" models)
- Resolution: $0.0005"/0.01\text{mm}$
- Stainless steel frame
- Easy-to-read display available in super large
- Absolute/Incremental Measurement
- 4-way measuring



Order No.	Range	Display Type	List Price	Sale Price
54-101-150-2	6"/150mm	Regular Display - includes FREE NIST Cert.	\$51.30	\$46.20
54-101-600-1	6"/150mm	Super Large Display with hold feature	66.90	60.30
54-101-200-1	8"/200mm	Regular Display	80.20	72.20
54-101-800-1	8"/200mm	Super Large Display with hold feature	100.20	90.20
54-101-300-1	12"/300mm	Regular Display - includes FREE NIST Cert.	102.40	92.20
54-101-900-1	12"/300mm	Super Large Display with hold feature	133.80	120.50

Prices & Specifications are subject to change without notice.

15

Fowler

TOOL-A-THON®

2020

Find us on social media!

Facebook, Twitter, LinkedIn, YouTube icons.

Machinist Grade Dial Calipers



52-008-706-0



- 0.001"/0.02mm reading dial face
- 0.100"/2mm range per revolution
- Solid stainless steel construction
- Tough shockproof gearing
- 4-way measuring

"Very precise with consistent readings. I would never change this analog for a digital one."
 Erick T.



52-008-707-0



Order No.	Range	Dial Face Color	Accuracy	Sale Price
52-008-714-0	0 - 4"	Black	± 0.001"	\$55.30
52-008-706-0	0 - 6"	White	± 0.001"	\$3.00
52-008-707-0	0 - 6"	Black	± 0.001"	\$3.00
52-008-708-0	0 - 8"	White	± 0.0015"	\$0.50
52-008-712-0	0 - 12"	White	± 0.002"	\$119.90
52-008-709-0	0 - 150mm	Yellow	± 0.02mm	\$3.00

Compare to Mitutoyo 505-746 @ \$191.29

0 - 6" Dial Calipers



52-008-005-0



52-008-007-0

- 0.001" reading dial face
- 0.100" per revolution
- Solid stainless steel construction
- 4-way measuring

over 50,000 SOLD!

Order No.	Range	Dial Face Color	Accuracy	List Price	Sale Price
52-008-005-0	0 - 6"/150mm	Black	± 0.001"	\$87.60	\$78.90
52-008-007-0	0 - 6"/150mm	White	± 0.001"	87.60	78.90

0 - 6"/150mm Vernier Caliper with Fine Adjustment

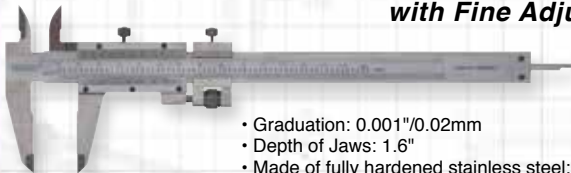

- Graduation: 0.001"/0.02mm
- Depth of Jaws: 1.6"
- Made of fully hardened stainless steel; microfine black graduations on a satin chrome finish for easy, precise reading
- Depth rod can be read directly from verniers
- Measuring faces are ground and lapped for extreme accuracy
- 4-way jaws for outside, inside, depth and step measurements
- All sliding surfaces are raised to prevent defacement and wear of graduations

Order No. 52-058-016-0

Sale \$47.10

List \$52.30

18" & 24" Extended Range Dial Calipers with Depth Rod



52-008-018-0

- Depth rod for full range measurements
- Graduations: 0.001"
- Stainless steel construction
- Satin chrome finish
- 0.500" internal measuring nibs



Order No.	Range	Accuracy	Jaw Depth	List Price	Sale Price
52-008-018-0	18"	± 0.003"	3.125"	\$264.90	\$238.50
52-008-024-0	24"	± 0.003"	3.375"	321.00	288.90

XTRA-RANGE[®] Electronic Calipers

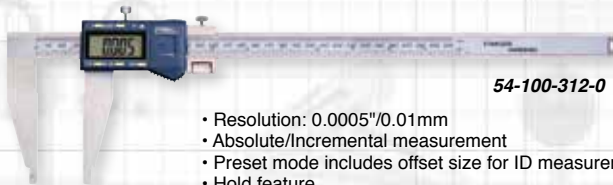

54-100-312-0

- Resolution: 0.0005"/0.01mm
- Absolute/Incremental measurement
- Preset mode includes offset size for ID measurements
- Hold feature
- All sizes feature fine adjustment screw
- Includes shop hardened case



Order No.	Range	Accuracy	Jaw Depth		Sale Price
54-100-312-0	12"/300mm	± 0.002"	3.5"		\$183.10
54-100-024-1	24"/600mm	± 0.003"	4"	Compare to Mitutoyo 550-225-10 @ \$1,018.99	303.10
54-100-042-1	40"/1000mm	± 0.004"	4.9"		902.50

Master Vernier Calipers



52-085-012-0

- Satin chrome finish on all models
- Hardened stainless steel throughout; ground and lapped for accuracy
- Machine divided and engraved from master for exceptional accuracy
- Verniers are adjustable for wear
- Open face design permits both vernier scales to be located on one side of the gage for both inside and outside measurements
- All sizes permit inside and outside measurements
- For larger workpieces, the long jaws permit greater accessibility and easier measurements
- Includes case

Order No.	Range	Graduation	Jaw Depth	List Price	Sale Price
52-085-012-0	12"/300mm	0.001"/0.02mm	3"	\$110.40	\$88.40
52-085-024-0	24"/600mm	0.001"/0.02mm	4"	189.20	151.40
52-085-040-0	40"/1000mm	0.001"/0.02mm	5-1/2"	629.50	503.60

Prices & Specifications are subject to change without notice.

TOOL-A-THON® Check us out! For Instructional and Training videos, subscribe to FowlerVid

Rapid-Mic Quick-Displacement Electronic Micrometers



54-815-030-C

**WORLD'S FINEST
Micrometer!**



Contact the Fowler Sales Department
1-800-788-2353

“I have been in the machining business for over 30 years this is by far the best mic I have ever had. One little thing or should I rephrase that, one huge thing, this mic comes with a lifetime warranty... no other company can provide that!”
John T.

NEW Bluetooth Ranges NOW Available!

- Non-rotating spindle with 10mm spindle travel per thimble rotation
- Adjustable measuring force, 5N/10N (54-815-030-0 only)
- USB output or bluetooth available
- Menu customizable with free software
- Position recall
- Automatic switch off



54-815-111-0



Order No.	Description	Max Error	Sale Price
54-815-030-0	0 - 1.18"/0 - 30mm	0.00012"/0.003mm	Compare to Mitutoyo 293-676-20 @ \$549.00 \$486.90
54-815-030-C	1.18"/30mm with ISO/A2LA Certification		490.70
54-815-060-0	1.18" - 2.6"/30 - 66mm	0.00016"/0.004mm	720.50
54-815-100-0	2.6" - 4.0"/66 - 102mm	0.00020"/0.005mm	1007.60
Set			
54-815-111-0	0 - 4"/0 - 102mm		2197.00
Bluetooth Model			
54-815-130-0	0 - 1.18"/0 - 30mm	0.00012"/0.003mm	720.50
54-815-160-0	1.18" - 2.6"/30 - 66mm	0.00016"/0.004mm - special order	953.40
54-815-110-0	2.6" - 4.0"/66 - 102mm	0.00020"/0.005mm - special order	1240.90
Bluetooth Set			
54-815-112-0	0 - 4"/0 - 102mm		2724.70
Connectivity Cables/Accessory			
54-115-526-0	Proximity cable with USB connection		135.00
54-115-527-0	Proximity cable with serial connection		135.00
54-115-246-BT	USB Bluetooth receiver		45.80



Bluetooth 0 - 1" Micrometer Kit

- Transmitter acts as a keyboard wedge
- Rechargeable battery (transmitter) with automatic switch off
- Accuracy: $\pm 0.00016"/0.004\text{mm}$
- Resolution: $0.00005"/0.001\text{mm}$
- Carbide measuring faces
- Absolute & incremental modes



Order No. 54-860-001-BT

Sale \$153.00

List \$170.00

XTRA-MIC PLUS+ Electronic Micrometers



54-880-001-0

Great for Shop Environments!

- Corrosive resistant ratchet thimble (anodized aluminum)
- Super large LCD display, 14mm height
- Resolution: $0.00005"/0.001\text{mm}$
- IP54 protected against fluid and dust
- Carbide tipped anvil and spindle
- SPC output
- Automatic switch off
- Sizes over 1"/25mm include a calibration standard
- Includes fitted case



FREE!



Order No.	Range	Accuracy	List Price	Sale Price
54-880-001-0	NEW 0 - 1"/0 - 25mm	0.00016"/0.004mm	\$142.20	\$113.80
54-880-002-0	NEW 1 - 2"/25 - 50mm	0.00016"/0.004mm	163.90	131.20
54-880-003-0	NEW 2 - 3"/50 - 75mm	0.0002"/0.005mm	175.20	140.20
54-880-004-0	NEW 3 - 4"/75 - 100mm	0.0002"/0.005mm	200.90	160.80
Set				
54-880-103-0	NEW 0 - 3"/0 - 75mm		\$452.30	\$361.90
Accessory				
54-115-100-0	Wireless transmitter		\$111.90	\$100.00
54-520-399-0	SPC cable (USB)		172.00	137.60

Prices & Specifications are subject to change without notice.

19

Fowler

TOOL-A-THON®

2020

Find us on social media!
Facebook, Twitter, LinkedIn, YouTube

Electronic Coolant Resistant Micrometers



54-860-001-1



- Resolution: 0.00005"/0.001mm
- Absolute & incremental modes
- Carbide measuring faces
- Ratchet thimble
- Automatic switch off
- Sizes over 1"/25mm include a calibration standard

Order No.	Range	Accuracy	Sale Price
54-860-001-1	0 - 1"/0 - 25mm	± 0.00016"/0.004mm	<i>Compare to INSIZE 310-25E @ \$139.00</i> \$114.30
54-860-002-1	1 - 2"/25 - 50mm	± 0.00016"/0.004mm	117.60
54-860-003-1	2 - 3"/50 - 75mm	± 0.0002"/0.005mm	128.30
54-860-004-1	3 - 4"/75 - 100mm	± 0.0002"/0.005mm	148.90
Set			
54-860-103-1	0 - 3"/0 - 75mm Set		\$334.10

XTRA-VALUE II Electronic Micrometers



54-870-001-0



- Resolution: 0.00005"/0.001mm
- Absolute & incremental modes
- Carbide measuring faces
- Ratchet thimble
- Automatic switch off
- Sizes over 1"/25mm include a calibration standard

Order No.	Range	Accuracy	List Price	Sale Price
54-870-001-0	0 - 1"/0 - 25mm	± 0.00016"/0.004mm	\$100.20	\$80.20
54-870-002-0	1 - 2"/25 - 50mm	± 0.00016"/0.004mm	108.20	86.60
54-870-003-0	2 - 3"/50 - 75mm	± 0.0002"/0.005mm	122.60	98.10
54-870-004-0	3 - 4"/75 - 100mm	± 0.0002"/0.005mm	137.10	109.70
Set				
54-870-103-0	0 - 3"/0 - 75mm		\$295.20	\$236.20

Digit Counter Micrometers



52-224-001-0



Over 24,000 SOLD!



52-224-103-0

- Graduation: 0.0001" (using vernier)
- Digital counter reads to 0.001"
- Microfine graduations on satin chrome
- Carbide tipped measuring faces and ratchet thimble
- Positive locking nut on spindle
- Sizes over 1"/25mm include a calibration standard
- Includes case

Order No.	Range		Sale Price
52-224-001-0	0 - 1"	Compare to Mitutoyo 193-211 @ \$121.17	\$105.50
52-224-002-0	1 - 2"		98.50
52-224-003-0	2 - 3"		112.20
52-224-004-0	3 - 4"		123.50
52-224-005-0	4 - 5"		130.70
52-224-006-0	5 - 6"		136.60
Sets			
52-224-103-0	0 - 3" set		\$296.00
52-224-104-0	0 - 4" set		419.70
52-224-220-0	0 - 75mm set		311.60

Outside Inch Micrometers

with Decimal Equivalents on Frame



52-235-001-1



- Graduations: 0.0001"
- Black decimal equivalents on satin chrome finished forged steel frame
- Carbide tipped measuring faces, ratchet thimble and locking nut
- Sizes over 1"/25mm include a calibration standard

Order No.	Range	Accuracy	Thimble		Sale Price
52-235-001-1	0 - 1"	± 0.0001"	Ratchet	Compare to Starrett T230RL @ \$223.00	\$54.70
52-235-002-2	1 - 2"	± 0.0001"	Ratchet		63.20
52-235-003-2	2 - 3"	± 0.0001"	Ratchet		79.10
Set					
52-235-100-0	0 - 3"				\$190.00

Fowler

TOOL-A-THON®

2020

Find us on social media!



0.0001" Outside Micrometers



52-240-001-1



52-215-003-1

- Graduation: 0.0001"
- Anvil & spindle hardened and precision ground with microlap finish on **carbide** tips (0.00003" flatness)
- Spindle thread hardened, ground and lapped for ultimate accuracy
- Microfine graduations on satin chrome finish
- Positive locking lever
- Includes a wrench and case
- Sizes over 1"/25mm include a calibration standard

Order No.	Range	Accuracy	Thimble	Sale Price
52-240-001-1	0 - 1"	± 0.00015"	Friction	<i>Compare to Brown & Sharpe 00180070 @ \$119.98</i> \$38.70
52-240-101-1	0 - 1"	± 0.00015"	Ratchet	38.70
52-240-002-1	1 - 2"	± 0.00015"	Friction	45.00
52-240-102-1	1 - 2"	± 0.00015"	Ratchet	45.00
52-240-003-1	2 - 3"	± 0.0002"	Ratchet	52.50
52-240-004-1	3 - 4"	± 0.0002"	Ratchet	58.60
52-240-005-1	4 - 5"	± 0.00025"	Ratchet	64.90
52-240-006-1	5 - 6"	± 0.00025"	Ratchet	71.10
52-240-007-1	6 - 7"	± 0.0003"	Ratchet	77.40
52-240-008-1	7 - 8"	± 0.0003"	Ratchet	91.00
52-240-009-1	8 - 9"	± 0.0003"	Ratchet	103.50
52-240-010-1	9 - 10"	± 0.0003"	Ratchet	117.30
52-240-011-1	10 - 11"	± 0.00035"	Ratchet	129.70
52-240-012-1	11 - 12"	± 0.00035"	Ratchet	142.20
Sets				
52-215-003-1	0 - 3" with standards and fitted shop hardened case			\$134.60
52-215-004-1	0 - 4" with standards and fitted shop hardened case			192.80
52-215-006-1	0 - 6" with standards and fitted wooden case			327.30
52-215-012-1	0 - 12" with standards and fitted wooden case			992.10
52-215-612-1	6 - 12" with standards and fitted wooden case			654.50

0.001" Outside Micrometers



52-253-001-1

- Graduation: 0.001"
- Anvil & spindle hardened and precision ground with microlap finish on **carbide** tips (0.00003" flatness)
- Positive locking lever
- Sizes over 1"/25mm include a calibration standard

Order No.	Range	Accuracy	Thimble		Sale Price
52-253-001-1	0 - 1"	± 0.001"	Friction	<i>Compare to Brown & Sharpe 599-1-44 @ \$117.90</i>	\$32.50
52-253-101-1	0 - 1"	± 0.001"	Ratchet		32.50
52-253-002-1	1 - 2"	± 0.001"	Friction		38.70
52-253-102-1	1 - 2"	± 0.001"	Ratchet		38.70
52-253-003-1	2 - 3"	± 0.001"	Ratchet		45.00
52-253-004-1	3 - 4"	± 0.001"	Ratchet		52.50
52-253-005-1	4 - 5"	± 0.001"	Ratchet		58.60
52-253-006-1	5 - 6"	± 0.001"	Ratchet		64.90

0.001" Outside Micrometer Set

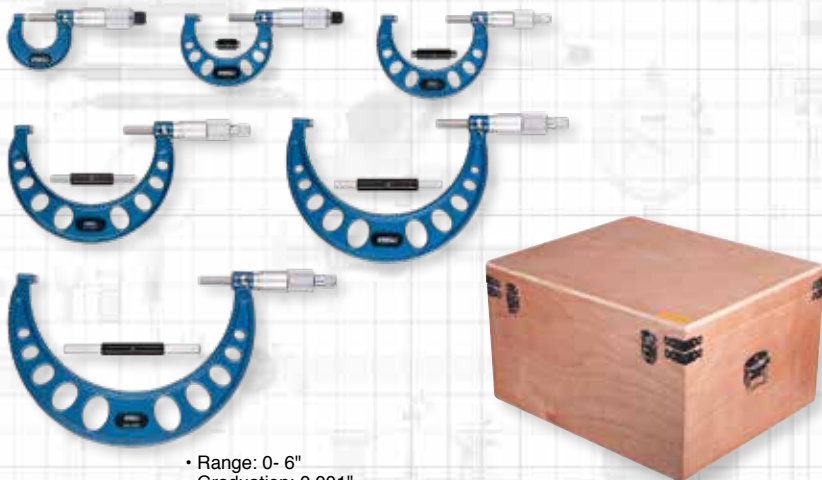

- Range: 0- 6"
- Graduation: 0.001"
- Anvil & spindle hardened and precision ground with microlap finish on **carbide** tips (0.00003" flatness)
- Positive locking lever
- Sizes over 1"/25mm include a calibration standard

Order No. 52-253-600-1

Sale \$297.⁹⁰

List \$331.00

Prices & Specifications are subject to change without notice.

Fowler

TOOL-A-THON®

2020



Find us on social media!

Vernier Thread Micrometers for measuring O.D. threads



52-219-001-1

- Graduation: 0.001"
- 60° measuring anvils
- Painted enamel and heat insulated frame
- Positive spindle lock
- Ratchet thimble
- Sizes over 1"/25mm include a calibration standard

Order No.	Range	Thread Range	Accuracy		Sale Price
52-219-001-1	0 - 1"	64 - 5 TPI/0.4 - 5mm	0.00016"	Compare to Mitutoyo 126-137 @ \$410.94	\$81.00
52-219-002-1	1 - 2"	44 - 3.5 TPI/0.6 - 7mm	0.00016"		89.00
52-219-003-1	2 - 3"	24 - 3.5 TPI/1 - 7mm	0.0002"		99.40
52-219-004-1	3 - 4"	24 - 3.5 TPI/1 - 7mm	0.0002"		108.90

Electronic IP65 Thread Micrometers



54-219-001-0

- Resolution: 0.00005"/0.001mm
- True inch/metric conversion
- 60° measuring anvils
- ABS/INC measuring mode
- Positive spindle lock
- Painted enamel and heat insulated frame
- Friction thimble
- IP65 rated for dust and coolant protection
- Sizes over 1"/25mm include a calibration standard



Order No.	Range	Thread Range	Accuracy	List Price	Sale Price
54-219-001-0	0 - 1"	64 - 5 TPI/0.4 - 5mm	± 0.00008"/0.002mm	\$240.00	\$216.00
54-219-002-0	1 - 2"	44 - 3.5 TPI/0.6 - 7mm	± 0.00008"/0.002mm	249.00	224.10
54-219-003-0	2 - 3"	24 - 3.5 TPI/1 - 7mm	± 0.00008"/0.002mm	265.00	238.50
54-219-004-0	3 - 4"	24 - 3.5 TPI/1 - 7mm	± 0.00012"/0.003mm	285.00	256.50

Thread Measuring Wire Set

- **NOW includes wire holders**
- 48 wires in 16 different, 3 wire sets
- Accuracy for sizes 0.018" through 0.108" is within +0/-0.0004"; sizes 0.120" through 0.185" is within +0/-0.0005"
- Measures all U.S. 60° threads from 3 - 48 threads per inch



Order No. 52-485-048-0

Sale \$28.70

List \$31.80

Vernier Inch Blade Micrometers



52-246-001-1

- Use blade micrometers to measure the outside diameter of workpieces which have narrow grooves, "T" slots and other dimensions
- Anvil & spindle hardened & precision ground with microlap finish on ends
- Non-rotating spindle
- Ratchet thimble
- Blade thickness = 0.030"; blade width = 0.256"; blade penetration = 0.315"
- Sizes over 1" include a calibration standard

Order No.	Range	Graduation	Accuracy	List Price	Sale Price
52-246-001-1	0 - 1"	0.0001"	0.00016"	\$220.90	\$176.80
52-246-002-1	1 - 2"	0.0001"	0.00016"	240.50	192.40
52-246-003-1	2 - 3"	0.0001"	0.0002"	251.10	200.90
52-246-004-1	3 - 4"	0.0001"	0.0002"	255.90	204.80

Electronic IP54 Blade Micrometers



54-860-241-0

- Accuracy: 0.00016"
- Resolution: 0.00005"/0.001mm
- True inch/metric conversion
- Friction thimble
- IP54 rated for dust and coolant protection
- Sizes over 1" include calibration standard



Order No.	Range	List Price	Sale Price
54-860-241-0	0 - 1" Blade Anvil	\$272.60	\$218.10
54-860-242-0	1 - 2" Blade Anvil with standard	296.10	236.90
54-860-243-0	2 - 3" Blade Anvil with standard	309.30	247.50
54-860-244-0	3 - 4" Blade Anvil with standard	323.70	259.00

Inside Micrometers

For measuring tubes, countersinks, bearings, slots and more!



52-275-001-1



52-275-005-0

- Measuring faces are fully hardened, precision ground and microlapped finished to assure exceptionally accurate readings
- Spindle threads are hardened and ground
- Microfine graduations 0.001" on a satin chrome finish permit easy reading
- Ratchet stop thimble assures exact and repetitive readings
- Includes a setting ring

Order No.	Range	Graduation	Accuracy	List Price	Sale Price
52-275-001-1	0.2" - 1.2"	0.001"	0.0002"	\$117.20	\$93.80
52-275-002-1	1" - 2"	0.001"	0.00024"	126.20	101.00
52-275-005-0	0.2" - 2.2"	0.001"	0.0002"	198.10	158.50

Inside Micrometers

for measuring large internal dimensions



52-243-212-1

- Graduation: 0.001"
- Accuracy: 0.00005" x (3 + L"/2)
- Each set consists of an inside micrometer head and a series of fully hardened and lapped extension rods of different lengths all with carbide measuring faces
- Anvil and spindle are hardened and precision ground with microlap finish on ends
- Microfine graduations on satin chrome
- Positive locking nut on spindle
- Quick, easy zero adjustment on the sleeve
- Includes a wrench, case and reference standard

Order No.	Range	List Price	Sale Price
52-243-026-1	2 - 6"	\$144.10	\$115.30
52-243-212-1	2 - 12"	178.00	142.40
52-243-220-1	2 - 20"	230.70	184.60
52-243-240-1	2 - 40"	610.00	549.00
52-243-480-1	4 - 80"	1820.00	1638.00
52-243-512-1	4 - 120"	3120.00	2808.00

Micrometer Inspection Set

Fowler's setting master is quick, easy and extremely accurate. It comes with a certificate of calibration and a fitted aluminum case. Save time and money by calibrating your own measuring tools quickly and easily.

Set Includes:

- Stand height: 12.5"
- 9 pc. Grade AS-0 gage block set (sizes: 0.625", 0.100", 0.125", 0.200", 0.250", 0.300", 0.500", 1.000" & 2.000"
- Certificate of calibration is traceable to NIST standards & provides the individual deviation of each block
- Optical flat (flatness: .000004" ; Parallelism: 0.00002")
- 4.0mm ball end T-handle hex wrench



Use blocks you already have, get the holder alone!

Order No.	Description	List Price	Sale Price
53-813-001-2	Complete Checking Set	\$351.50	\$281.20
53-813-002-0	Mic Checker <i>without</i> blocks	176.20	141.00

Micrometer Stands

3 styles to suit your space!



52-247-005-0

- Unique locking nut adjusts micrometer stand to any position for perfect use and viewing
- Stand folds for storage



52-247-000-0

- Provides a measuring position and angle for outside micrometers and other instruments

XTRA MAG

52-247-010-0

- Holds standard 0-12" micrometers firmly to metal surfaces
- Use at machine centers, work, assembly and inspection stations, steel tables and shelves
- V-bottom for mounting on cylindrical surfaces
- On/Off magnet switch
- Base is 2.30" L x 1.20" W x 3.50" H



Micrometer not included

Order No.	Description	List Price	Sale Price
52-247-000-0	Adjustable Micrometer Stand	\$61.00	\$48.80
52-247-005-0	Folding Micrometer Stand	40.90	32.80
52-247-010-0	Magnetic Micrometer Stand	70.00	63.00

Prices & Specifications are subject to change without notice.

TOOL-A-THON® Check us out! For Instructional and Training videos, subscribe to FowlerVid



Fowler-Bowers **BLUETOOTH** XTH3 Holematic Pistol Grip Sets



TABLET!

with Complete Set Purchase!



BOWERS GROUP



"Fowler-Bowers makes an awesome product!"

T.T.

NOW
available with
ISO Cert.

54-567-050-BT

Contact the Fowler Sales Department
1-800-788-2353

- Pistol grip design significantly increases measuring time
- To reduce hand fatigue, the travel of the Holematic trigger is adjustable for minimum over travel
- Self centering 3 point heads above 0.250"
- USB and Bluetooth connectivity
- Resolution: 0.00005"/0.001mm
- Protected to IP67 specifications
- Tungsten carbide measuring faces on all 3-point heads from 0.5" (12.5mm) and up
- Sizes over 0.500" (12.5mm) feature blind bore capability
- Includes UKAS certificates for all pistol grip, heads and rings



Contact the **Fowler Technical Department** for special measuring applications

Order No.	Range	Includes	List Price	Sale Price
54-567-009-BT	0.080" - 0.250"/2 - 6mm (2-point heads)	5 heads, 1 handle, 3 rings	\$6322.70	\$5374.30
54-567-010-BT	0.250" - 0.375"/6- 10mm	2 heads, 1 handle, 1 ring	2479.20	2107.40
54-567-020-BT	0.375" - 0.750"/10 - 20mm	3 heads, 1 handle, 2 rings	2900.40	2465.40
54-567-050-BT	0.750" - 2" /20 - 50mm	3 heads, 1 handle, 2 rings	3745.00	3183.30
54-567-100-BT	2 - 4"/50 - 100mm	3 heads, 1 handle, 2 rings	4168.40	3543.20
54-567-105-BT	4 - 6"/100 - 150mm	2 heads, 1 handle, 1 ring	3745.00	3183.30
54-567-110-BT	6 - 8"/150 - 200mm	2 heads, 1 handle, 1 ring	4943.30	4201.90
54-567-200-BT	4 - 8" /100 - 200mm	4 heads, 1 handle, 2 rings	7824.30	6650.70
54-567-210-BT	0.750" - 4"/20 - 100mm	6 heads, 1 handle, 4 rings	6094.40	5180.30
54-567-620-BT	0.250" - 0.750"/76 - 20mm	5 heads, 1 handle, 3 rings	3456.70	2938.20
Connectivity Cables/Accessory				
54-115-526-0	Proximity cable with USB connection		\$143.00	\$135.00
54-115-527-0	Proximity cable with serial connection		143.00	135.00
54-115-246-BT	USB bluetooth receiver		50.80	45.80



Fowler-Bowers **BLUETOOTH** XTD3 Electronic Holemike Sets



BOWERS GROUP

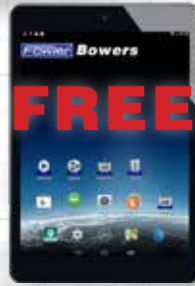

FREE

TABLET!

with Complete Set Purchase!



NOW
available with
ISO Cert.

Contact the Fowler Sales Department
1-800-788-2353



- Features traditional style ratchet stop thimble
- Self centering 3 point heads above 0.250"
- USB and Bluetooth connectivity
- Resolution: 0.00005"/0.001mm
- Protected to IP67 specifications
- Sizes over 1"/25mm offer extended travel
- Includes UKAS certificates for micrometer, heads and settings rings



54-367-110-BT

Contact the Fowler Technical Department for special measuring applications

Order No.	Range	Includes	List Price	Sale Price
54-367-000-BT	0.080" - 0.250"/2 - 6mm (2-point heads)	5 heads, 1 handle, 3 rings	\$5762.20	\$4897.90
54-367-010-BT	0.250" - 0.375"/6 - 10mm	2 heads, 1 handle, 1 ring	2400.90	2040.80
54-367-020-BT	0.375" - 0.750"/10 - 20mm	3 heads, 1 handle, 2 rings	2865.00	2435.30
54-367-050-BT	0.750" - 2" /20 - 50mm	3 heads, 1 handle, 2 rings	3890.80	3307.20
54-367-100-BT	2 - 4"/50 - 100mm	3 heads, 1 handle, 2 rings	4307.70	3661.60
54-367-105-BT	4 - 6"/100 - 150mm	2 heads, 1 handle, 1 ring	3636.70	3091.20
54-367-110-BT	6 - 8" /150 - 200mm	2 heads, 1 handle, 1 ring	4803.90	4083.40
54-367-200-BT	4 - 8" /100 - 200mm	4 heads, 1 handle, 2 rings	7590.70	6452.10
Connectivity Cables/Accessory				
54-115-526-0	Proximity cable with USB connection		\$143.00	\$135.00
54-115-527-0	Proximity cable with serial connection		143.00	135.00
54-115-246-BT	USB bluetooth receiver		50.80	45.80

Prices & Specifications are subject to change without notice.

MicroGage

2-Point Small Bore Gaging System

Replaces 100's of pin gages!



The Fowler-Bowers MicroGage 2-point bore gaging system has been designed specifically for the measurement of small bores between 1.0 - 6.0 mm. The measuring heads are equipped with spherical, split-ball, hard-chromed contact points.

- System range : 0.040" - 0.250"/1 - 6mm
- Switchable resolution 0.0005", 0.00005"/0.01, 0.001, 0.0005mm
- Repeatability : 0.00005"/0.001mm
- Sets include setting rings
- UKAS-certificates as standard with all setting rings
- Depth stops available, *call our technical department 1-800-788-2353*

Order No.	Description	List Price	Sale Price
54-551-010-0	0.037" - 0.096"/0.95 - 2.45mm	\$3281.10	\$2953.00
54-551-011-0	0.060" - 0.167"/1.5 - 4.25mm	3211.20	2890.10
54-551-012-0	0.089" - 0.250"/2.25 - 6.35mm	3385.50	3047.00
54-551-013-0	0.242" - 0.405"/6.15 - 10.35mm	2979.50	2681.60
Connectivity Cables			
54-115-526-0	Proximity cable with USB connection	\$143.00	\$135.00
54-115-527-0	Proximity cable with serial connection	143.00	135.00

Bore Gage Setting Master Kits - Inch & Metric

Fowler's Bore Gage Setting Master Kit is used for accurately setting any 2-point bore gage up to 6"/150mm in diameter to an accuracy of 0.0001"/0.003mm

Each Set includes:

Setting Device (53-646-000-1 - Inch Model)

- Base anvil: 3.950" x 1.050"
- Adjustable anvil 2.375" x .375" (two each)
- Internal capacity: 6"/150mm
- Depth capacity: 1"/25mm
- Centralizer capacity width: 2.750"
- Quick-release holder for fast adjustment
- **Can also be used for external setting, depending on application (external mics, snap gages, caliper gages)**

Economy Gage Block Sets

- Inch model:*
- 36 piece
 - Tolerances to .00005"
 - Certificate of Calibration to NIST

- Metric model:*
- 33 piece
 - AS-2 grade
 - Certificate of Calibration to NIST



Instructional video available at youtube.com/FowlerVid

53-646-000-1 Bore gage shown not included

Includes:
Bore gage setting master and gage block set.
All in a custom-fitted case!

Order No.	Description	List Price	Sale Price
53-646-000-1	Inch Bore Gage Setting Master Kit	\$350.00	\$315.00
53-646-010-0	Metric Bore Gage Setting Master Kit	332.30	265.90

Dial Bore Gage Sets with Carbide Anvils

- Easy to set and read
- Graduation: 0.0005", 0.0001" or 0.01mm
- 2-point measuring system
- Insulated grip
- 9.5" measuring depth
- Chrome plated handle
- Economical
- Includes fitted case



52-646-100-0

XTENDER



52-646-400-0



Order No.	Range	Graduation	Sale Price
52-646-100-0	0.7 - 1.5"	0.0005"	\$142.40
52-646-300-0	2 - 6"	0.0005"	117.80
52-646-400-0	1.4 - 6"	0.0005"	Compare to Mitutoyo 511-753 @ \$304.68 179.00
52-646-500-0	1.4 - 6"	0.0001"	224.20
52-646-220-0	35 - 160mm	0.01mm	197.70

XTENDER

Electronic Bore Gage Set

with Carbide Anvils

Industry's two most popular bore gage ranges combined in one easy-to-use electronic set!

Preset size of master for absolute reading and use minimum hold feature to lock on the bore size as the gage is rocked in the part to be measured.

Bore Gage features:

- Range: 1.4 - 6"/35 - 150mm
- Resolution: 0.00005"/0.001mm
- Self-centering
- Bar graph and numeric digital display
- Preset with recall
- ABS/INC measurement
- Min/Max/TIR

*"Excellent quality,
well built."*

Lee C.



Learn more at
YouTube
FowlerVid



Order No. 54-646-401-0

Sale \$309.¹⁰

List \$343.40

Fowler

TOOL-A-THON®

2020

Find us on social media!
f E in You

Fowler - Sylvac Hi_Cal Electronic Height Gages

- Extra low measuring force, from 0.2N
- Measure internal and external diameters, centerlines, heights, widths, depths and MIN/MAX/TIR capability
- Excellent repeatability thanks to the motorized carriage
- High reliability
- Data output USB and RS232
- Battery life: 40 hours rechargeable during operation
- Touch sensitive probe speed for easy operation
- Base with small footprint
- Includes: protective cover, charging set, ruby ball probe Ø3mm, setting gage and calibration certificate

NOW
 available with
ISO Cert.

Contact the Fowler Sales Department
 1-800-788-2353



54-931-150-0

Accessory Probe Sets



54-930-215-0

Watch the Demo!

FowlerVid



54-930-217-0

FREE 1mm Ball Probe with

Order No.	Range
54-931-150-0	6"/150mm
54-931-150-C	6"/150mm <i>with ISO/A2LA Certification</i>
54-931-300-0	12"/300mm
54-931-300-C	12"/300mm <i>with ISO/A2LA Certification</i>
54-931-450-0	17.5"/450mm
54-931-450-C	17.5"/450mm <i>with ISO/A2LA Certification</i>
Accessories	
54-930-215-0	Full Probe Accessory Set
54-930-217-0	Basic Probe Accessory Set



Fowler

TOOL-A-THON®

2020

FREE Basic Probe Set
with 54-931-450-0 Hi_Cal Purchase
\$623.80 Value!

6"/150mm & 12"/300mm Hi_Cal Purchase

Accuracy	List Price	Sale Price
0.00013"/0.0034mm	\$4898.40	\$4408.60
0.00016"/0.0042mm	5629.20	4633.60
0.00020"/0.005mm	6354.00	5381.30
		5718.60
		6033.60
	\$1350.00	\$1215.00
	750.00	675.00

Prices & Specifications are subject to change without notice.

33

Find us on social media!

f E in You

V-Series Special Pricing!

Fowler - Trimos V3, V4 & V5 Electronic Height Gages

The Fowler-Trimos V3, V4 and V5 vertical measuring instruments have been developed for the most difficult workshop environments. Manufactured entirely in Switzerland, they guarantee a robust, precise and reliable product in the long run.

- "Black mask" display with user friendly functions
 - Electronically adjustable measuring force 0.75/1.5 (N)
 - Lithium-ion rechargeable batteries
 - All adjustments possible without tools
 - Cast iron base for optimal stability
 - RS232 and USB interfaces requires 54-192-112-0 cable
 - Dual probe holders (V4 and V5 Only)
 - Carriage displacement: Manual
(V5 includes selectable manual or motorized carriage displacement)
 - Measures heights, diameters, perpendicularity, centerlines, Min/Max/Delta
 - Resolution: 0.00005"/0.001mm
 - Repeatability (2s): 0.00008"/0.002mm (Ø 0.00016"/0.004mm)
- All V Models Include:**
- Charging unit
 - Measuring insert with ruby ball Ø4mm
 - Probe holder elbow Ø 8mm
 - Setting gage
 - User's manual and test certificate



Free Swiss Knife & Fowler Hat with Any V3, V4 & V5 purchase!



V3	54-192-340-0	54-192-370-0
Measuring Range	16"/407mm	28"/711mm
Range with Probe inverted	20"/508mm	31.9"/812mm
Max. Permissible Errors	0.00028"/0.007mm	0.00032"/0.008mm
Frontal Squareness Deviation	0.0004"/0.010mm	0.0006"/0.015mm
Air Cushion		NO

V4	54-191-440-0	54-191-470-0
Measuring Range	16"/407mm	28"/711mm
Range with Probe inverted	28.3"/719mm	40.2"/1023mm
Max. Permissible Errors	0.0002"/0.005mm	0.00028"/0.007mm
Frontal Squareness Deviation	0.0004"/0.010mm	0.0006"/0.015mm
Air Cushion		YES

V5	54-199-540-0	54-199-570-0
Measuring Range	16"/407mm	28"/711mm
Range with Probe inverted	28.3"/719mm	40.2"/1023mm
Max. Permissible Errors (µm)	2.5 + L(mm)/300	
Frontal Squareness Deviation	0.0002"/0.005mm/0.00032"/.008mm	
Air Cushion	YES	



Order No.	Description	Range	List Price	Sale Price
54-192-340-0	V3 Height Gage	16"/407mm	\$4588.50	\$4129.70
54-192-370-0	V3 Height Gage	28"/711mm	5059.00	4553.10
54-191-440-0	V4 Height Gage	16"/407mm	6044.10	5439.70
54-191-470-0	V4 Height Gage	28"/711mm	7031.20	6328.10
54-199-540-0	V5 Height Gage	16"/407mm	6661.40	5995.30
54-199-570-0	V5 Height Gage	28"/711mm	7894.00	7104.60
Probe Sets				
54-199-105-0	4mm Probe Set, 21 piece		\$1765.30	\$1588.80
54-199-106-0	8mm Probe Set, 16 piece		1317.30	1200.00
54-199-107-0	Economy Probe Set, 7 piece		467.70	450.00
Accessories				
54-199-400-0	12"/300mm Holder - for 8mm probes		\$988.20	\$889.40
54-777-120-0	Vmux software - for connecting multiple units to one PC		465.50	395.00
54-199-022-BT	Bluetooth module (V4 and V5 only)		509.70	458.80



16"/407mm
\$4,129.⁷⁰
Order No: 54-192-340-0

16"/407mm
\$5,439.⁷⁰
Order No: 54-191-440-0



28"/711mm
\$7,104.⁶⁰
Order No: 54-199-570-0



EXTREMELY
Easy to Use!

Z-HEIGHT Electronic Height Gages

New Design!

- **NEW** base design with painted enamel finish has a more comfortable grip and is finely ground and lapped for smooth movement on surface plates
- **NEW** fine adjust feature allows precise adjustment to required settings
- **NEW** preset feature allows setting pre-determined or reference measurements
- **NEW** 2 indicator holding bars included (3/8" and 8mm)
- Direct inch/metric conversion
- Resolution 0.0005"/0.01mm
- Floating zero
- Large, high contrast LCD display
- Coarse adjustment hand wheel
- Carriage locking lever
- Carbide tipped scriber



Order No.	Range	Accuracy	Sale Price
54-175-012-0	12"/300mm	± 0.0015"/0.04mm	\$477.00
54-175-018-0	18"/500mm	± 0.002"/0.05mm	556.00
54-175-024-0	24"/600mm	± 0.002"/0.05mm	625.80

Compare to Mitutoyo 570-314 @ \$882.53



54-175-024-0

Z-HEIGHT ABS

Electronic Height Gages with Wireless Capability

- **NEW Design** ABS measuring system
- Supplied with a NIST certified test block (1" x 2" x 3")
- Includes indicator holding bar (3/8" and 8mm)
- Supplied with mini USB data cable
- Heavy duty single column design
- Carbide scriber
- Ground and lapped base for smooth movement
- Steel rack with large hand wheel for coarse and fine adjustment
- Positive locking level for scribing
- Can be used with wireless transmitter (54-115-100-0)

Order No.	Range	Accuracy	List Price	Sale Price
54-175-012-1	12"/300mm	± 0.002"/0.05mm	\$607.80	\$547.10
54-175-024-1	24"/600mm	± 0.002"/0.05mm	822.10	739.90
Accessory				
54-115-100-0	Wireless transmitter		\$111.90	\$100.00



54-175-012-1

Twin Beam Dial Height Gages

A must for every shop!

- Separate digit counters register both upward & downward travel
- Zero setting can be obtained throughout the gage's range
- Coarse readings in 0.100" graduations: fine readings taken on indicator are 0.001"
- Dual chrome plated beams
- Carbide-tipped scriber.
- Base is hardened, ground & lapped for maximum flatness

52-174-212-0



Order No.	Range	Accuracy		Sale Price
52-174-212-0	12"/300mm	± 0.0015"/0.04mm		\$269.60
52-174-224-0	24"/600mm	± 0.002"/0.05mm	Compare to Mitutoyo 192-152 @ \$1,329.99	449.30

Twin Beam Electronic Height Gages with Offset Scriber

- Updated electronic and mechanical design with offset scriber offers better accuracy and movement of carriage
- Base is ground and lapped for flatness
- Handwheel provides course and fine movement
- Carbide tipped scriber
- Functions include preset, in/mm conversion and ABS/INC for direct or comparative measuring

54-174-212-3



Order No.	Range	Accuracy	List Price	Sale Price
54-174-212-3	12"/300mm	± 0.0016"/0.04mm	\$499.20	\$399.40
54-174-224-3	24"/600mm	± 0.002"/0.05mm	698.80	629.00
Accessory				
54-174-226-0	Contact sensor		\$25.00	\$22.50

Fowler

TOOL-A-THON®

2020



Find us on social media!

Tool Presetter

For checking of heights and diameters (radii) of various tools by using a fixed, precise, steel column (Z axis) and a constant measuring force measuring arm (X axis).

Tool Holding Spindle

Tool presetter is supplied with high precision ball cage bearing (Grade 0).

High precision spindle has:

- Less than 2 μm concentricity error



Display

- Resolution: 0.00005"/0.001mm
- MIN/MAX functions for TIR readings
- 2 reference indications for measurement comparison
- Function for PRESET value and TOLERANCE value inputs
- Tolerance mode indication for upper and lower values
- Radius or diameter indication on X-axis display
- Display hold to retain readings
- Output - OPTO RS232 for each axis available
- Floating zero function anywhere within axis range
- Carbide measuring insert for durability
- Accepts measuring probes with 8mm shank for unique applications



Additional Features

- Counter balanced measuring carriage
- Constant measuring force of horizontal measuring arm ensures high accuracy
- **High precision Sylvac measuring system**

Applications



Height Measurement



Diameter/Radius Measurements



Checking of a Runout

Order No.	Description	List Price	Sale Price
54-188-300-0	Tool Presetter	\$10,049.50	\$9350.00
54-121-000-0	ISO 50/45 Tool Pot Adaptor	1131.20	
54-121-005-0	ISO 50/40 Tool Pot Adaptor	772.40	
54-121-010-0	ISO 50/35 Tool Pot Adaptor	1131.20	
54-121-015-0	ISO 50/30 Tool Pot Adaptor	878.70	
54-188-333-0	ISO 50 Setting Gage	568.00	
54-188-335-0	ISO 40 Setting Gage	1136.10	

X-PRO™

Surface Roughness Tester

- 2 selectable parameters: Ra and Rz
- Small, compact size
- Large LCD display
- Meets ISO and DIN standards
- N.I.S.T. traceable specimen included
- Uses 9 volt battery (approx. 3000 measurements)
- Includes fitted case



54-410-500-0

The X-Pro Portable Roughness Tester II can be used for many applications by selecting from a variety of accessories, including:

- Stand with swivel
- A variety of probes

RS232 is available on certain models (contact the Fowler Technical Department for more information 1-800-788-2353)



(X-Pro shown with optional stand with swivel)

X-Pro Portable Roughness Tester II

Order No.	Description	Sale Price
54-410-500-0	Portable Surface Roughness Tester 0.0004" probe (NIST specifications) <i>Compare to MAHR EMD-1500-311 @ \$2113.74</i>	\$1666.70
54-410-600-0	Portable Surface Roughness Tester 0.0002" probe (DIN specifications) <i>Compare to MAHR EMD-1500-311 @ \$2113.74</i>	1666.70

X-Pro Portable Roughness Tester II Stand with Swivel

Order No.	Description	Sale Price
54-400-896-0	Stand with Swivel Attachment	\$441.00

X-Pro Portable Roughness Tester II Probes and Accessories

Order No.	Description	Resolution	Sale Price
54-400-319-0	General Purpose Probe	0.0004"	\$720.00
54-400-326-0	General Purpose Probe	0.0002"	720.00
54-420-321-0	Small Bore Probe	0.0004"	778.50
54-420-327-0	Small Bore Probe	0.0002"	778.50
54-420-301-0	Traverse Chisel Probe	0.0004"	778.50
54-420-302-0	Parallel Chisel Probe	0.0004"	778.50
54-420-328-0	Groove Bottom Probe	0.0004"	778.50
54-420-120-0	AC Adapter Kit		61.40

Prices & Specifications are subject to change without notice.

X-PROOF® Water Resistant Indicator Set



Magnetic Base (52-585-010-0):

- Fine adjustment
- Base dimensions: 2" x 2-11/32" x 1-13/16"
- Also mounts test indicators with 1/4" post
- 85 lb. pull
- On-Off lever release magnet
- V-base for placing on round surfaces



X-Proof Indicator (52-520-450-0):

- Travel: 1"
- Reading: 0.001"
- Continuous reading: 0 - 100
- Tolerance markers
- AGD Group 2, 2-1/4" dia.
- Lugback and carbide point
- Robust, shockproof design
- Rubber bellows on stem
- O-ring seal on safety cap
- O-ring protection for bezel and rotating dial
- Sealed back plate



Over 20,000 SOLD!

Order No. 52-585-155-0

Sale \$77.00

List \$92.00

CHROME FLEX MAG SET™ with X-PROOF™ Indicator

Flex Arm Mag Base:

- Corrosion resistant chrome plated flex arm
- 85 lb. pull magnet
- Holds rigidly in almost any position
- V-base for mounting on rounded surfaces

Magnetic Indicator Back:

- Use for positioning the indicator on most metal surfaces
- Protective coating

X-Proof IP54 Indicator:

- Robust, shockproof design
- Travel: 1"
- Reading: 0.001"
- Continuous reading: 0 - 100
- Tolerance markers
- AGD Group 2, 2-1/4" dia.
- Lugback and carbide point

Included Magnetic Indicator Back for mounting to most metal surfaces!



Protection Includes:

- Rubber bellows on stem
- O-ring seal on safety cap
- O-ring protection for bezel and rotating dial
- Sealed back plate

Order No.	Description	Dial Color	List Price	Sale Price
52-585-450-0	Chrome Flex Mag and X-Proof Indicator Set	White	\$200.70	\$160.60
52-585-455-0	Chrome Flex Mag and X-Proof Indicator Set	Black	207.00	160.60

Magnetic Base and Dial Indicator Combo

- Includes 1" indicator and mag base, rods, swivel clamps and case
- The 2-1/4" diameter 0.001" indicator features: satin chrome finish, tolerance hands, lug back and revolution counter
- The 6" high mag base features a 1.5" x 1.5" x 1.75" 50 lb. pull base and a 4.5" long sidearm. All exposed metal is finished in anodized black for corrosion resistance.
- Includes shop-hardened case



Order No. 52-522-101-0

Sale \$95.00

List \$116.40

Articulating Magnetic Base and Indicator Sets



52-585-150-0

AGD Indicator:

- 1" travel
- Continuous reading: 0-100
- AGD group 2, 2-1/4" dial diameter
- Tolerance markers
- Carbide tipped point

Articulating Mag Base:

- Fine adjust
- 85 lb. pull
- V-slot on base for mounting on rounded surfaces



54-585-250-0

INCH • METRIC • FRACTION

Indi-X blue FRACTION Electronic Indicator

- Auto Off feature
- 2-1/4" dial face
- Lugback and 3/8" stem mountings
- Resolution 0.0005"/0.01mm/64ths
- Tolerance indicators
- Absolute/incremental reading
- Carbide tipped point



Order No.	Description	List Price	Sale Price
52-585-150-0	Articulating Mag Base and AGD Indicator Set	\$183.90	\$147.20
54-585-250-0	Articulating Mag Base and Indi-X Blue Set	206.50	165.20
52-520-110-0	AGD Indicator ONLY	72.90	60.00
54-520-260-0	Indi-X Blue Indicator ONLY	113.80	102.50
52-585-008-0	Articulating Mag Base ONLY	106.80	85.50

Prices & Specifications are subject to change without notice.

Fowler

TOOL-A-THON®

2020



Find us on social media!

X-DEPTH 22-0 - 22" Electronic Depth Gauge



- 0 - 1" travel electronic indicator
- Resolution 0.0005"/0.01mm
- Zero reset at any position
- Relative/absolute measuring
- Bottom surface of the base is hardened, ground and lapped
- Full 22" range
- Hold feature
- 4" Base
- Includes 2 extra points for small hole applications; one 0.078" dia. x 1" long and one needle point x 1" long

Order No. 54-125-777-0



Sale \$246.50

List \$273.80

X-DEPTH 22 0 - 22" Dial Depth Gages

Twice the range of competitive products!

- 0 - 1" travel dial indicator
- 0.001" Graduations
- Rods connect together for full 22" capacity
- Satin chrome finish
- Base size: 4"
- Includes 2 extra points for small hole applications; one 0.078" dia. x 1" long and one needle point x 1" long



52-125-006-1



inch/metric model

52-125-008-0



Order No.	Range	Graduation	Accuracy	List Price	Sale Price
52-125-006-1	0 - 22"	0.001"	± 0.001"	\$203.20	\$182.90
52-125-008-0	0 - 22"/558mm	0.001"/0.01mm	± 0.001"/0.03mm	221.50	150.00

X-PROOF® 0 - 22" Dial Depth Gauge with IP54 protection!



- 0-1" AGD Group 2 IP54 Indicator
- Sealed bezel, top cap and dial with bellows on stem
- Sealed back plate
- .001" graduations
- 4" base ground and lapped for flatness
- Rods connect for 22" capacity
- Includes 2 extra points (spline & needle)
- Tolerance markers

Order No. 52-125-007-0



Sale \$150.00

List \$220.80

Premium Depth Micrometers

- Clear microfine graduations on satin chrome finish
- Base constructed of hardened tool steel and is precision ground and microlapped
- Quick and easy zero adjustment
- Rods hardened, ground and lapped on measuring surfaces and adjustable in either direction
- Interchangeable rods are fitted to the micrometer spindle against a positive stop and locked
- Ratchet thimble
- Threads hardened, ground and lapped for accuracy
- Includes spanner wrench and fitted case

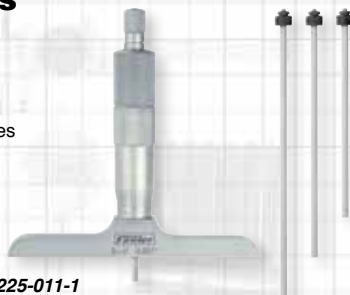

52-225-011-1

Order No.	Range	Graduation	Accuracy	Base Size	List Price	Sale Price
52-225-006-1	0 - 4"	0.001"	0.0002"	2.5"	\$199.40	\$159.60
52-225-011-1	0 - 4"	0.001"	0.0002"	4"	199.40	159.60
52-225-015-1	0 - 6"	0.001"	0.0002"	4"	227.20	181.80
52-225-020-1	0 - 6"	0.001"	0.0002"	2.5"	218.90	175.20
52-225-030-1	0 - 12"	0.001"	0.00028"	2.5"	339.30	271.50
52-225-035-1	0 - 12"	0.001"	0.00028"	4"	354.50	283.60

Digit Counter Depth Micrometers

- Easy-to-read digit counter
- 4" base constructed of tool steel, hardened and ground
- Satin chrome finish
- Ratchet thimble
- Locking clamp
- Rod diameter: 0.176"
- Includes wrench and fitted case

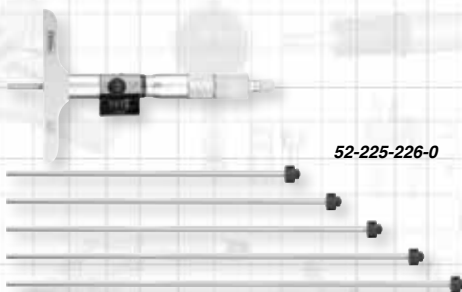

52-225-226-0

Order No.	Range	Accuracy	Graduation	Base	List Price	Sale Price
52-225-176-0	0 - 6"	0.0002"	0.001"	2.5"	\$199.70	\$159.80
52-225-226-0	0 - 6"	0.0002"	0.001"	4"	206.50	165.20

IP54 Electronic Depth Micrometer



- Range: 0 - 6"/150 mm
- Accuracy: 0.00016"/0.004mm
- Resolution: 0.00005"/0.001mm
- Hardened tool steel, precision ground and microlapped 4" base
- Rod diameter: 0.176"
- Protected to IP54 standards
- Automatic switch off
- Large LCD display
- Includes fitted case

Order No. 54-225-456-0

Sale \$210.⁶⁰

List \$234.00

Prices & Specifications are subject to change without notice.

0 - 12"/300mm Light-Line Digital Depth Gage

- Accuracy: 0.0015"/0.04mm
- Beam made of oxide coated aluminum with double inner prismatic guide ways
- Bases made of hard anodized aluminum
- Includes three base attachments: 150/300/450mm length
- Includes two contact points (ball and offset)
- Electronics feature on/off, floating zero and direct in/mm conversion
- 0.0005"/0.01mm resolution and repeatability
- Includes a fitted case, instructions, 2 spare base screws, 2 hex wrenches and test certificate



Measures Internal Grooves

Lightweight!

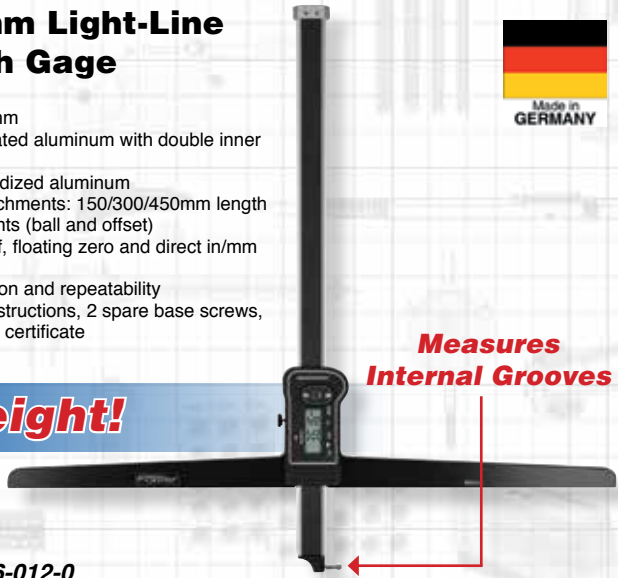

Order No. 54-136-012-0

Sale \$443.⁸⁰

List \$493.10

Light-Line Digital Depth Gages with adjustable base

- Adjustable base can be mounted in 3 different locations for offset applications
- Light weight beam made of oxide coated aluminum
- Bases made of hard anodized aluminum
- Includes 1 base attachment 350mm (14")
- Includes two contact points (1 ball and 1 disk)
- Electronics feature on/off, floating zero and direct in/mm conversion
- 0.0005"/0.01mm resolution and repeatability
- Includes fitted case, instructions, 2 base screws, hex wrench and test certificate



54-136-512-0

Measures depths, counter bores, steps, grooves and more!

Order No.	Range	Accuracy	List Price	Sale Price
54-136-512-0	0 - 12"/300mm	0.0015"/0.04mm	\$686.00	\$617.40
54-136-535-0	0 - 31"/800mm	0.0024"/0.06mm	1500.60	1200.50

Internal & External Electronic Caliper Gages



54-554-611-0



54-554-711-0

- Accuracy: $\pm 0.0008''/\pm 0.02\text{mm}$
- Resolution: $0.0002''/0.005\text{mm}$
- Rugged housing
- Large, LCD display
- Preset capability
- Absolute/Incremental measurements
- High-impact, aircraft aluminum case



Dimensions for Internal Calipers

Metric	Inch	L	S	H	Tip Radius
5-15mm	0.2-0.6"	20mm	1.0mm	1.5mm	0.3mm
5-25mm	0.2-1.0"	35mm	1mm	1.5mm	0.3mm
10-30mm	0.4-1.2"	55mm	2mm	3.5mm	0.5mm
20-40mm	0.8-1.6"	80mm	3mm	6.5mm	0.5mm
30-50mm	1.2-2.0"	80mm	3mm	8.5mm	0.5mm

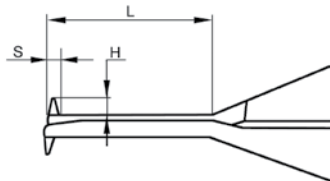

Dimensions for External Calipers

Metric	Inch	L	S	H	Tip Radius
0-10mm	0-0.4"	40mm	3mm	8mm	0.5mm
0-20mm	0-0.8"	80mm	6.5mm	25mm	0.75mm
10-30mm	0.4-1.2"	80mm	6.5mm	25mm	0.75mm
20-40mm	0.8-1.6"	80mm	6.5mm	25mm	0.75mm
30-50mm	1.2-2.0"	80mm	6.5mm	25mm	0.75mm

Internal Caliper Gages

Order No.	Range	List Price	Sale Price
54-554-611-0	0.200" - 0.590"/5 - 15mm	\$193.80	\$174.50
54-554-622-0	0.200" - 1"/5 - 25mm	207.80	187.10
54-554-623-0	0.400" - 1.2"/10 - 30mm	217.50	195.80
54-554-624-0	0.790" - 1.6"/20 - 40mm	217.50	195.80
54-554-625-0	1.2" - 2"/30 - 50mm	217.50	195.80

External Caliper Gages

Order No.	Range	List Price	Sale Price
54-554-711-0	0 - 0.400"/0 - 10mm	\$193.80	\$174.50
54-554-722-0	0 - 0.790"/0 - 20mm	207.80	187.10
54-554-723-0	0.4" - 1.2"/10 - 30mm	217.50	195.80
54-554-724-0	0.790" - 1.6"/20 - 40mm	217.50	195.80
54-554-725-0	1.2" - 2"/30 - 50mm	217.50	195.80

XTRA-VALUE

Internal & External Electronic Caliper Gages



54-554-630-0

Check us out!
YouTube
FowlerVid

INCH • METRIC • FRACTION™

- Accuracy: $0.01''/0.3\text{mm}/1/64\text{ths}$
- Reading: $0.01''/0.1\text{mm}/1/64\text{ths}$
- Robust housing
- Large LCD display
- Battery: CR2032
- Spring loaded with locking nut

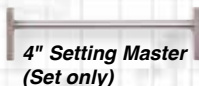

Order No.	Description	Range	List Price	Sale Price
54-554-630-0	Outside Caliper Gage	0 - 6"/0 - 150mm	\$52.90	\$47.70
54-554-730-0	Inside Caliper Gage	0.5 - 6"/12.7 - 150mm	52.29	47.70
54-554-650-0	Inside/Outside Caliper Gage Set includes 4" internal setting master		\$92.80	\$83.60

Prices & Specifications are subject to change without notice.

mini-MAG Protractor™

The mini-MAG Protractor provides instant 360° digital inclination display of any angle with the additional unique feature of embedded magnets on both sides and the bottom which make it ideal for a variety of measurements.



- Accuracy: $\pm 0.2^\circ$
- Resolution: 0.05°
- Repeatability: 0.05°
- Measuring range: 360° (4 x 90°)
- Embedded magnets with 3.5lb. pull
- Display automatically inverts
- Dimensions: 2.375" x 1.375" x 2.375"
- Hold feature
- Battery Life: up to 250 hrs. (9V)



Display inverts for easy reading!



Over 26,000 SOLD!

Order No. 54-422-450-1

Sale \$95.00

List \$106.80

mini-MAG PLUS

The Mini-Mag PLUS Protractor features a USB rechargeable battery, a backlit display, Tilt% function and IP54 protection against water, oil, and fluids.

- Accuracy: $\pm 0.2^\circ$
- Resolution: 0.05°
- Repeatability: 0.05°
- Measuring range: 360° (4 x 90°)
- Embedded magnets
- Display automatically inverts
- Smaller size: 2.12" x 2.12" x .9"
- Hold feature
- Auto off after 5 minutes

Order No. 54-422-500-0

Sale \$106.00

List \$118.10



XTRA-VALUE Digi-Level

The Xtra-Value Digi-Level provides instant 360° digital inclination display of any angle. Features aluminum housing, with large LCD, reading hold, absolute 0° at sea level.

- Measuring Range: 360° (4 x 90°)
- Resolution: 0.05°
- Accuracy: $\pm 0.2^\circ$ maximum error
- Repeatability: $\pm 0.05^\circ$
- Dimension: 4" L x 1" W x 3" H
- Battery Life: up to 250 hrs. (9V)

Larger measuring surfaces!

Order No. 54-422-444-0

Sale \$120.30

List \$133.60



Block not included

Digi Level PLUS+



- Super large 18mm backlit display
- Includes a 6" straight edge with beveled edge and 1/64th graduations
- Smart wireless model available
- Accuracy: $\pm 0.2^\circ$
- Resolution: 0.050°
- V's on top and bottom for measuring on cylindrical surfaces
- Embedded magnets on bottom base for vertical and horizontal hold
- IP65 protection
- USB Rechargeable battery
- USB charging cable supplied
- Auto inverting display

Vertical Positioning



Horizontal Positioning



Order No. 54-422-550-0

Sale \$114.²⁰

List 126.80

Fowler Digi-Pro Electronic Protractors

The Digi-Pro electronic protractor includes embedded magnets for unique measurement areas. On/Off, Zero, Hold and Reverse feature to invert the display for easier reading in certain situations.

- Accuracy: $\pm 0.2^\circ$
- Resolution: 0.05°
- Repeatability: $\pm 0.05^\circ$
- Embedded 25 lb. pull magnets
- Full, 360° measuring range
- Invertible display feature
- Uses standard 3V lithium battery

54-440-775-1



54-440-740-1



Check us out!
YouTube
FowlerVid

Use the Digi-Pro to make fast and accurate angular measurements!

Order No.	Description	List Price	Sale Price
54-440-740-1	4" Digi-Pro Electronic Protractor	\$93.00	\$83.00
54-440-775-1	12" Digi-Pro Electronic Protractor	111.50	99.00

Universal Electronic Protractor

- Accuracy: ± 5 minutes
- Resolution: 30 seconds
- Hardened stainless steel
- Range selection: 1 x 360°, 2 x 180°, 4 x 90°
- Dual reading LCD display arc minutes/decimal degrees
- Preset function
- 6" and 12" blades and acute angle attachment included
- Fine adjustment
- Measuring range: 0 - 360°

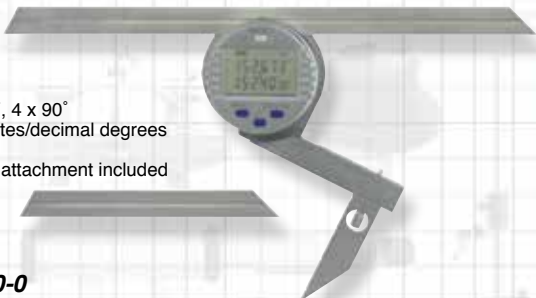

Order No. 54-440-750-0

Sale \$273.⁰⁰

List \$341.40

Prices & Specifications are subject to change without notice.

For Instructional and Training videos, subscribe to FowlerVid

Check us out!

TOOL-A-THON®



SHOP-BLOX® Rectangular Gage Block Set



- Tolerances to $\pm 0.00005"$
- 36 pieces
- Manufactured to meet N.I.S.T. Federal Specification ASME B89. 1.9 - 2002 tolerances on length for inch gage blocks
- Certificate of Calibration traceable to N.I.S.T.
- In high-quality fitted wood case

Order No. 53-672-036-1

Sale \$255.00

List \$324.90

Grade Ø Rectangular Steel Gage Block Sets

- Grade Ø
- Certificate of Calibration traceable to N.I.S.T.
- Each block is individually serialized
- Sizes clearly marked on each block
- Complete with fitted wooden case



A better grade for finer work!

53-670-038-0

Order No.	Description	List Price	Sale Price
53-670-038-0	36 piece Grade Ø Rectangular Gage Block Set	\$494.20	\$395.00
53-670-080-0	81 piece Grade Ø Rectangular Gage Block Set	909.40	725.00

8 Piece Gage Block Set



- Fowler's long gage blocks are rectangular in shape, Grade Ø and supplied with an NIST certificate
- Stackable using holding clamps

53-670-008-0

Order No.	Description	List Price	Sale Price
53-670-008-0	8 piece Gage Block Set	\$2595.00	\$2335.00
53-670-777-0	Holding Clamp for two or more large blocks	104.70	82.00

QUICK CHECK

Multi-Function Check Standard



Check

- ✓ Height Gages
- ✓ Micrometers
- ✓ Depth Gages
- ✓ Bore Gages
- ✓ Test & Dial Indicators
- ✓ Caliper Gages
- ✓ Protractors & more



- Accuracy of indicated values $\pm 0.003\text{mm}$
- All sizes marked are actual
- One compact, multi-function, precise standard
- Can be used to check and verify a multitude of measuring instruments
- Supplied with a manufacturer's test certificate and fitted wood case

Order No. 53-813-015-0

Sale \$1440.²⁰

List \$1694.30

Large Square Gage Blocks

- Grade 0
- NIST Traceable
- Vertically more stable than rectangular blocks
- Large sizes help eliminate block stacks
- Meets or exceeds Federal Specification ASME B89.1.9-2002



Order No.	Description	List Price	Sale Price
53-676-216-0	5" Large Square Gage Block	\$285.00	\$256.50
53-676-218-0	6" Large Square Gage Block	355.00	319.50
53-676-220-0	7" Large Square Gage Block	420.00	378.00
53-676-222-0	8" Large Square Gage Block	470.00	423.00
53-676-224-0	10" Large Square Gage Block	645.00	580.50
53-676-226-0	12" Large Square Gage Block	745.00	670.50
53-676-228-0	16" Large Square Gage Block	1030.00	927.00
53-676-230-0	20" Large Square Gage Block	1650.00	1485.00

Prices & Specifications are subject to change without notice.

COAX-2D

2 Dimensional Coaxial Indicator Set - Inch

Use the 2D Coaxial Set for accurate component centering and positioning in most machining applications. The dial remains stationary during the rotation of the machine spindle.

- 1.6"/42.5mm diameter dial
- Graduations 0.0005"/0.01mm
- Repeatability to within 0.0002" (0.005mm) of true center
- 3 Internal and 3 External feelers
- Center point feeler
- Restraining arm

Specifications:

- Length: 6-7/8" (175mm)
- Shank: 3/8" dia. x 7/8" (10mm x 20mm) long
- Feeler ball: 1/8" (3mm) dia.
- Dial readings: 0-50
- Measuring range: 0.250" (6mm) axis offset
- Speed—recommended not to exceed approx. 800 RPM
- Capacity depends on feelers installed, but overall range is 5/32-12" (4-300mm) internal diameter; 0-12" (0-300mm) external diameter



Order No. 52-710-025-0

Compare to Blake COA-850 @ \$399.95

Sale \$230.⁶⁰

2", 3", 4" and 6" Steel Square Set



- Made of the finest carbon tool steel, these squares have true right angles both inside and outside
- Beams and blades ground and lapped for straightness and parallelism
- Hardened blade
- Beam grooved at inner corner for clearance of burrs and dirt
- Squareness of blade edge to the working face: 2" & 3" = ± 0.0006", 4" & 6" = ± 0.0008"

Order No. 52-432-246-0

Sale \$81.³⁰

List \$90.30

Cylindrical Squares

- Used for checking squares, height gages and other instruments
- Hardened and the ends are lapped to 90° angular accuracy
- 6" cylindrical squares: ± 0.0001"
- 12" cylindrical square: ± 0.00015"

52-750-006-0

52-750-012-0



Solid and Stable!

Order No.	Description	List Price	Sale Price
52-750-006-0	6" cylindrical square	\$203.00	\$182.70
52-750-012-0	12" cylindrical square	289.90	261.00

Straight Edges **PLUS+**



52-480-070-0

- Beveled edge with 1/64th graduations
- Satin chrome finish on scale
- Hardened steel
- 0.21" thick, 1.59" wide
- Storage sleeve included

Order No.	Description	Straightness	List Price	Sale Price
52-480-065-0	6"	0.0015"	\$26.00	\$20.80
52-480-070-0	8"	0.0015"	31.00	24.80
52-480-075-0	12"	0.0015"	44.00	35.20
52-480-080-0	24"	0.0025"	67.00	53.60

Combination Square

- Blades are chrome plated, fully hardened and tempered
- Includes square, protractor and center head with 12" blade
- Square head has level and scribe point
- Double indexed protractor is graduated 180° in both directions
- Graduated in 8ths, 16ths, 32nds and 64ths



Order No. 52-370-012-0

Compare to Starrett 434-12-4R @ \$297.69

Sale \$172.00

Carbide Super Scriber



- Lightweight
- Retractable carbide tip
- Knurled grip
- Machined aluminum body
- Pocket clip

Order No.	Description	Overall Length	List Price	Sale Price
52-500-050-0	Carbide Super Scriber	6.5"	\$36.10	\$32.50
52-500-055-0	Carbide Refill		11.10	10.00

Screwdriver Kit

- This precision Screwdriver and Tool Set is ideal for miniature work
- Features knurled and chromed swiveling handles
- Screwdriver and Tool Set contains **9 screwdrivers**, **1 tapered point scratch awl** and **1 magnetic pick-up tool**
- Screwdriver size range: #00, #0, #1, 1/32", 3/64", 1/16", 5/64", 3/32" and 1/8"



Order No. 52-490-003-0

Sale \$27.00

List \$30.00

Prices & Specifications are subject to change without notice.

Fowler

TOOL-A-THON®

2020



Find us on social media!

1/8" Parallel Set

- Made from high-grade alloy steel, hardened and ground from 1/8" stock with 2 holes in each parallel
- 10 pairs, 6" length, 1/8" width
- 1/2", 5/8", 3/4", 7/8", 1", 1-1/8", 1-1/4", 1-3/8", 1-1/2" & 1-5/8"
- Height specifications relate to consistency within each pair.
- Absolute heights are nominal.
- Parallelism: $\pm 0.0002"$
- Hardness 58 - 63 HRC
- Paired in height: $\pm 0.001"$



Order No. 52-437-000-0

Sale \$196.40

List \$245.50

1-2-3 & 2-3-4 Blocks

- 23 holes for easy clamping
- Sold in pairs
- Hardened 56 - 60 HRC
- Useful in layout, machine setup, grinding work and inspection
- Features 5 threaded holes for joining and setup



52-439-234-0

Order No.	Description	Accuracy	List Price	Sale Price
52-439-031-0	1-2-3 Blocks	$\pm 0.0001"/1"$	\$96.20	\$77.00
52-439-234-0	2-3-4 Blocks	$\pm 0.0001"/1"$	110.00	92.00

Planer and Shaper Gage adjustable setup tool



- 1/4" to 6-1/4" range
- Base size 3/4" x 5"
- Extensions 1" and 3"
- Base and slide are beveled to provide accurate alignment and parallelism
- Base and slide are hardened
- Supplied with 1" and 3" extension posts, maximum height 6-1/4"
- Precision level ensures accuracy
- Platform has extra tapped holes to accommodate post for dial indicators and other accessories
- Fitted wood case

Order No. 52-460-005-0

Sale \$167.40

List \$209.20

X-BLOX V-Block Set



2 each @:

- Dimensions: 1-1/2" L x 1-1/4" W x 1-1/4" H
- Work capacity: Approximately 1"

2 each @:

- Dimensions: 2" L x 1-1/2" W x 1-1/2" H
- Work capacity: 1-1/2"

All feature:

- Surfaces are square and parallel within 0.0005"
- V-grooves are square and parallel with all surfaces within 0.0005"
- Corresponding dimensions for each pair are alike within 0.0005"



"You will not go wrong buying this product"

J.B

Order No. 52-475-500-0

Sale \$124.¹⁰

List \$137.80

V-Block Set



• Accuracy: 0.0004"

- Height: 2", Length: 2-3/4", Width: 2"
- Two clamps, with screw hole at 90 degrees for positive clamping of work, are included.
- Clamping capacity= 2" (50mm)
- V-Blocks are constructed with stepped grooves which allow the clamps to be inserted without protrusion, thus allowing V-Blocks to be used on base, ends or sides.
- Hardened steel. All sides of V-Blocks precision ground parallel and square within .0004".
- Matched pair of V-Blocks are perfectly aligned with 90 degree V-grooves ground central and parallel to the sides and base

Order No. 52-475-555-0

Sale \$201.¹⁰

List \$251.30

All-Angle V-Block

- For grinding, milling, drilling and inspection
- Made of hardened and precision ground tool steel
- Sides are parallel and vee is central and ground to 0.0003"
- Central hole is provided for drilling or removing pins.
- V-Block has four 3/8" - 16 tapped holes, two in the bottom and one on each side for angle non-clamping
- Dimensions: 3-5/8" long x 1-7/8" wide x 1-7/8" high (including clamp)
- Holding capacity: 1-5/16"



Order No. 52-475-050-0

Sale \$85.⁵⁰

List \$95.00

Fowler

TOOL-A-THON®

2020



Find us on social media!

American Made Tools!



52-330-012-1

America Rules

- Made in the USA
- Available in 4R, 5R and IN/MM graduations

GRADUATIONS	
4R:	8ths, 16ths, 32nds, 64ths
5R:	32nds, 64ths, 10ths, 100ths
IN/MM:	32nds, 64ths, 0.5mm, 1mm

EZ-Read High Contrast Rules

- Hardened stainless steel
- White, microfine graduations against a black background provide a non-glare finish which is extremely easy-to-read

Satin Chrome Rules

- Tempered steel
- Non-glare satin chrome finish
- Sharp easy-to-read graduations

Golden Rules

- Titanium finish = RC80 for superior wear resistance on flat surfaces
- 30% harder finish than standard chrome rules

RIGID STEEL RULES

Order No.	Finish	Size	Reading	Sale Price
52-307-006-1	Black	6"	5R	\$22.80
52-307-012-1	Black	12"	5R	36.40
52-330-006-1	Satin Chrome	6"	4R	22.80
52-330-012-1	Satin Chrome	12"	4R	<i>Compare to Starrett C304SRE-12 @ \$53.87</i> 36.40
52-380-005-1	Satin Chrome	6"	IN/MM	23.70

FLEXIBLE STEEL RULES

Order No.	Finish	Size	Reading	Sale Price
52-297-006-1	Black	6"	4R	\$22.80
52-297-012-1	Black	12"	4R	36.40
52-300-006-2	Satin Chrome	6"	5R	<i>Compare to Starrett C305R-6 @ \$25.50</i> 22.80
52-300-012-1	Satin Chrome	12"	5R	36.40
52-309-006-1	Golden	6"	5R	50.10
52-309-012-1	Golden	12"	5R	100.00
52-380-006-1	Satin Chrome	6"	IN/MM	22.80

Screw Pitch Gages



52-485-051-0

- Narrow designed blades permit use for internal and external screw threads
- Locking device at each end to secure all blades for storage or position
- Correct pitch is determined by matching blade teeth with threads
- Precisely ground and finished
- Blades marked with thread size



Order No.	Description	List Price	Sale Price
52-485-051-0	Inch Screw Pitch Gage with 51 blades: 4 to 84 pitch standard V thread	\$55.00	\$44.00
52-485-018-0	Metric Screw Pitch Gage with 18 blades: 0.50 to 7.0mm center gage with coarse and fine notch included	22.00	17.60
52-485-027-0	In/mm Screw Pitch Gage with 28 blades Inch: 4 to 56 pitch, Metric: 0.50 to 6.00mm	22.00	17.60

American Made Tools!

Electronic Edge Finders

- Six equally spaced light ports provide visibility at any angle
- Edge finder lights instantly when stylus touches work edge
- Repeatability: 0.0002"
- Works on any conductive metal



Along with light indication, model #54-575-650-0 emits an audible "beep" at time of contact.

Order No.	Stylus	Shank	Audible	Battery	List Price	Sale Price
54-575-600-0	0.200"	1/2"	NO	12 volt	\$42.00	\$37.80
54-575-625-0	0.200"	1/2"	NO	12 volt	145.00	130.50
54-575-650-0	0.400"	3/4"	YES	12 volt	145.00	130.50

M5 Edge Finder

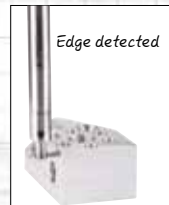

- With this tool edges can be detected with doors open and spindles off
- Solves safety door lock issues
- High repeatability and accuracy at 0.0005"
- Indicates centerline of spindle at 0.20" from edge
- Made from 4140 pre-hardened steel
- Easy viewing without obstruction of coolant covered windows

Order No. 52-575-150-0

Sale \$100.00

List \$116.20

Audible Edge Finders

Audible edge finders assist in assuring accuracy by releasing an audible click when the tip jumps. This allows the operator to listen as well as watch the tool.



52-575-040-0

- Available in three sizes
- Hardened and ground on all working surfaces



52-575-060-0

Order No.	Description	List Price	Sale Price
52-575-040-0	3/8" x 0.200"	\$23.00	\$18.40
52-575-045-0	1/2" x 0.200"	22.00	17.60
52-575-060-0	1/2" x 0.500"	22.00	17.60

Prices & Specifications are subject to change without notice.



Headquarters

66 Rowe Street • Newton • Massachusetts 02466
(800) 788-2353 • (617) 332-4137 fax
sales@fowlerprecision.com

Distribution Center & Showroom

28010 Industry Drive
Valencia, California 91355
(415) 633-5354