

MeasurLink ENABLED
Data Management Software by Mitutoyo



SUMMER PROMO 2020

PRECISION TOOLS & INSTRUMENTS

Effective June 1 through August 31, 2020

SUMMER PROMO 2020

BULK BUY

Stock-up and SAVE



Buy in Bulk and SAVE on the world's most popular precision measuring tools!



Dear Valued Customers,

I want to take a moment to express my sincere appreciation for your continued support and commitment to Mitutoyo products and services.

Inside the pages of the 2020 Summer promotion, you will find a lot of great deals on a variety of Mitutoyo tools and instruments including data management solutions, calipers, micrometers, linear encoders, indicators, height gages, microscopes, hardness testers and profile projectors. Be sure to take advantage of our new BULK BUY, stock-up and SAVE offer! Prices are Effective June 1 through August 31, 2020.

You can find all of the latest promotions, products and events on our website, www.mitutoyo.com.

Thank you for trusting us with your metrology needs.

Sincerely,

Matthew B. Dye

Matt Dye
President, Mitutoyo America Corporation

BULK BUY

Buy in Bulk and save by purchasing in factory package quantities. Purchasing the factory package quantity* reduces our labor and shipping costs, and we pass that savings directly to you. Purchase the factory package and **Save up to 15%.**

*Qualifying quantities must be in increments of the Bulk Quantity.



500-171-30



500-196-30

Digimatic Calipers

10% OFF

PART NO.	DESCRIPTION	LIST	BULK BUY EACH	BULK QTY
B500-171-30	DIGIMATIC CALIPER, 6"/150MM, W/OUTPUT	\$188.00	\$169.20	25*
B500-196-30	DIGIMATIC CALIPER, 6"/150MM, NO OUTPUT	\$161.00	\$144.90	25*



293-185-30



293-344-30

Digimatic Micrometers

15% OFF

PART NO.	DESCRIPTION	LIST	BULK BUY EACH	BULK QTY
B293-180-30	QUANUMIKE MICROMETER, DIGIMATIC, 0-1", IP65, .00005", W/OUTPUT	\$270.00	\$229.50	40*
B293-185-30	QUANTUMIKE MICROMETER, DIGIMATIC, 0-1", IP65, .00005", NO OUTPUT	\$233.00	\$198.05	40*
B293-340-30	1" RATCHET STOP MICROMETER, IP65, NO OUTPUT	\$193.00	\$164.05	40*
B293-344-30	1" RATCHET THIMBLE MICROMETER, IP65, NO OUTPUT	\$193.00	\$164.05	40*



513-402-10E



513-403-10E



24165

Dial Test Indicators

15% OFF

PART NO.	DESCRIPTION	LIST	BULK BUY EACH	BULK QTY
B513-402-10E	DIAL TEST INDICATOR, BASIC SET, STANDARD, .03 IN, .0005 IN GRAD	\$134.00	\$113.90	50*
B513-403-10E	DIAL TEST INDICATOR, BASIC SET, STANDARD, .008 IN, .0001 IN GRAD	\$174.00	\$147.90	50*

Dial Indicator

15% OFF

PART NO.	DESCRIPTION	LIST	BULK BUY EACH	BULK QTY
B24165	DIAL INDICATOR, 1" RANGE, .001" GRADUATIONS	\$123.00	\$104.55	40*

BULK BUY



505-742



505-742-56

Dial Calipers

15% OFF

PART NO.	DESCRIPTION	LIST	BULK BUY EACH	BULK QTY
B505-742	CALIPER, DIAL, .1"/REV, 0-6", .001"	\$125.00	\$106.25	25*
B505-742-56	CALIPER, DIAL, BLACK DIAL, .1"/REV, 0-6", .001"	\$125.00	\$106.25	25*



543-783B

Digimatic Indicators

15% OFF

PART NO.	DESCRIPTION	LIST	BULK BUY EACH	BULK QTY
B543-783	DIGIMATIC INDICATOR, ID-S1012EX, .5" RANGE, .0005 RESOLUTION	\$182.00	\$154.70	20*
B543-783B	DIGIMATIC INDICATOR, ID-S1012EXB, .5" RANGE, .0005 RESOLUTION, FLAT BACK	\$182.00	\$154.70	20*

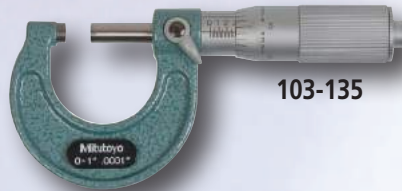

103-135

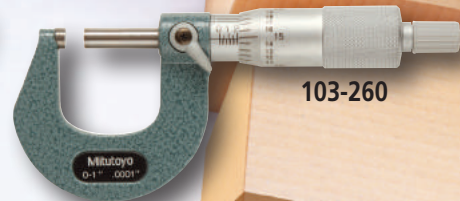

103-260

Mechanical Micrometers

15% OFF

PART NO.	DESCRIPTION	LIST	BULK BUY EACH	BULK QTY
B103-135	MECHANICAL MICROMETER, 0-1", 0.0001" GRADUATIONS, FRICTION THIMBLE	\$123.00	\$104.55	60*
B103-260	MECHANICAL MICROMETER, 0-1/0.0001" GRADUATIONS, RATCHET STOP	\$122.00	\$103.70	60*



178-561-02A

Surface Roughness Testers

10% OFF

PART NO.	DESCRIPTION	LIST	BULK BUY EACH	BULK QTY
B178-561-02A	SJ-210 IN 4MN (STANDARD DRIVE UNIT)	\$2,430.00	\$2,187.00	5*
B178-563-02A	SJ-210 IN 4MN (R-DRIVE UNIT). RETRACTABLE DRIVE UNIT	\$2,740.00	\$2,466.00	5*



U-WAVE^{fit}

MeasurLink^{ENABLED}
Data Management Software by Mitutoyo



Mitutoyo's new U-Wave Fit wireless data transmitter fits to the back of popular Mitutoyo hand-held measuring instruments. This new design allows for a snug fit behind the display resulting in a more ergonomic feel. U-Wave Fit is the same technology as the U-Wave T, just a smaller version.



U-WAVE-TM for micrometers and U-WAVE-TC for calipers are available both as, the buzzer and water/dust-proof IP67 types. The buzzer type notifies the normal reception of data by LED and buzzer sound. The water/dust-proof IP67 type is designed for harsh environments and therefore, is only equipped with LED notification of data reception.

10% OFF

U-WAVE-T (Transmitter)

Order No.	Model	Measuring Instrument*	Remarks	List	Promo
264-620	U-WAVE-TC	4", 6", 8", 12" IP67 caliper/standard caliper	IP67/LED	\$190.00	\$171.00
264-621	U-WAVE-TC	4", 6", 8", 12" IP67 caliper/standard caliper	Buzzer/LED	\$190.00	\$171.00
264-622	U-WAVE-TM	COOLANT-PROOF (IP65) micrometer	IP67/LED	\$190.00	\$171.00
264-623	U-WAVE-TM	COOLANT-PROOF (IP65) micrometer	Buzzer/LED	\$190.00	\$171.00
02AZF310	Connection unit	IP67 caliper/COOLANT-PROOF (IP65) micrometer	Waterproof	\$70.00	\$63.00
02AZF300	Connection unit	Standard caliper	Standard	\$70.00	\$63.00

* Please contact Mitutoyo or distributor for further details

U-WAVE-R (Receiver)

Order No.	Remarks	Software	Number of U-WAVE-R units that can be connected to PC	Number of U-WAVE-T units that can be connected	List	Promo
02AZD810D	U-WAVE-R + software	U-WAVE PAK	Up to 15	Up to 100	\$499.00	\$449.10

- The transmitter is designed to fit in the space behind the display, and the connecting cable has been replaced by a rigid connector
- Approx. 20 m transmission range (within visible range)
- 2.4GHz wireless system for reliable and secure data transmission
- Easy data export to Microsoft® Excel® or SPC software applications
- Transmitter confirms data transfer by an LED signal and optional buzzer
- An IP67 transmitter is available to ensure a coolant-proof gaging system
- Low power consumption: 400,000 data transmissions with a single battery

Standard U-Wave Wireless System

MeasurLink^{ENABLED}
Data Management Software by Mitutoyo

U-WAVE is a wireless system that connects to a gage with SPC output. The data is sent to a receiver that is connected to a PC through a USB connection.

- > 2.4 GHz ZigBee wireless with a 60ft range.
- > HID compatible (Keyboard Entry) and Serial (VCP).
- > Supports Mitutoyo Digimatic or Digimatic 2 Type A, B, C, D, E, F, G.
- > Includes U-WAVEPAK Setup Software.

Order No.	Description	List	Promo
02AZD730G	U-WAVE-T/IP67 TYPE	\$220.00	\$198.00
02AZD880G	U-WAVE-T/BUZZER TYPE	\$220.00	\$198.00
02AZD810D	U-WAVE-R	\$499.00	\$449.10
02AZD790A	U-WAVE CONNECTING CABLE A	\$110.00	\$99.00
02AZD790B	U-WAVE CONNECTING CABLE B	\$110.00	\$99.00
02AZD790C	U-WAVE CONNECTING CABLE C	\$110.00	\$99.00
02AZD790D	U-WAVE CONNECTING CABLE D	\$110.00	\$99.00
02AZD790E	U-WAVE CONNECTING CABLE E	\$110.00	\$99.00
02AZD790F	U-WAVE CONNECTING CABLE F	\$110.00	\$99.00
02AZD790G	U-WAVE CONNECTING CABLE G	\$110.00	\$99.00



Prices effective June 1 through August 31, 2020

Data Collection – Store. Send. Print.

DP-1VA LOGGER

The DP-1VA collects data from a Digimatic gage which can be stored, exported to software or printed.



Data Logger:

- Data can be stored internally, printed and/or sent to a PC as it is measured or after all data has been collected.
- Up to 1,000 measurements can be stored.

Timer:

- Data collection can be triggered by a timer function.
- The DP-1VA can collect data unattended to measure changes over time.

Tolerance and SPC:

- Tolerances can be set in the unit, and statistics can be calculated and printed directly from the DP-1VA.
- No additional software is required.

Features:

- d2 compatible
- A gage with SPC output is connected to the DP-1VA with an SPC cable.
- The data for each part measured is printed, saved or sent directly to a PC through a USB cable.
- This data can be triggered by the button on the gage, cable or the DP-1VA. An optional footswitch can also be used.



264-505A



USB connection allows collected data to be easily transferred from the DP-1VA to the PC. The output is HID or VCP so data can be sent directly to Excel® or data collection software such as IT-Pak or MeasurLink®.

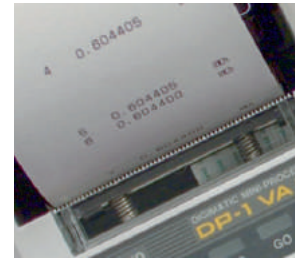

Digimatic 2 function allows the high resolution of the gage to be output in its entirety in metric or inch.



"d2" is the name for Mitutoyo Digimatic output compatible with up to 8 digits of I/O data.

Order No.	Model	List	Promo
264-505A	DP-1VA	\$514.00	\$488.30

Purchase the world's first 5μinch /0.1μm resolution micrometer and receive a USB input tool and cable (\$280 value)

Using precision digital measuring tools together with a USB input tool improves both measurement results and data reliability. The latest version of Digimatic output, d2, allows output to a resolution of 1 millionths of an inch. The high-accuracy MDH with 5 millionths resolution can output in its entirety in both inch and metric. Resulting data can input directly to Excel®, MeasurLink® or other SPC programs.

To receive this special offer, use promo code: **PROMO026**.

> Range: 0-1", Resolution: .000005", Accuracy: +/- .000020

Part #	Description	List Price
PROMO026	Package: MDH Mic, SPC Cable, USB Input Tool	\$1,680.00
293-130-10	MDH Micrometer with high accuracy, high resolution output	\$1,680.00
05CZA662	SPC CONNECTING CABLE (1M)	\$83.80
264-016-10	USB INPUT TOOL	\$197.00



293-130-10



264-016-10



05CZA662

Package



www.mitutoyo.com

Quickmikes

The new Quickmike series still boasts the super-fast spindle feed rate that's **20x faster** than standard micrometers.

IP65 protection – can be used around cutting fluids

- > MIN Hold – the minimum measurement can be held on the display for more repeatable and accurate measurements
- > Larger LCD – 33% larger, 10mm character height
- > Function lock – prevents accidental changes
- > 5 year battery life – more operating time, less downtime looking for and replacing batteries
- > Non-rotating spindle



293-676-20



293-677-20



MeasurLink ENABLED
Data Management Software by Mitutoyo

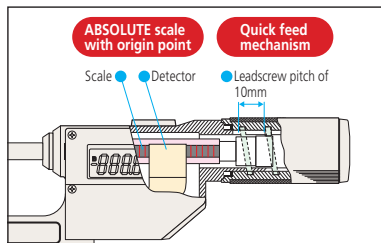

ABSOLUTE™

The ABS (ABSOLUTE) linear scale eliminates the need for origin point setting at every power-on and achieves high reliability while being free from overspeed error.

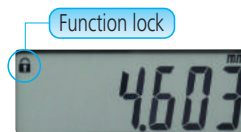

Minimum-value hold function ensures measurement value is retained

COOLANT PROOF™ IP65

Order No.	Range	Resolution	Accuracy	Flatness	Parallelism	List	Promo
293-676-20	0 - 1.2"	.00005"/0.001mm	±0.0001"	0.000012"	0.00008"	\$611.00	\$580.45
293-677-20	1 - 2.2"	.00005"/0.001mm	±0.0001"	0.000012"	0.00008"	\$667.00	\$633.65

SPC cable with data switch – 1m: 05CZA662 2m: 05CZA663

Caliper and QuantuMike Tool Kit

Tool Kit includes:

- QuantuMike **293-185-30**
- Digimatic Caliper **500-196-30**
- Mahogany Case **64PPP932**



\$378.90 Promo

\$421.00 List Price

Order No. **64PKA152**

10% OFF

QuantuMike Micrometer

4X Faster Spindle Travel

- > Faster measurement with 2mm travel per revolution instead of the standard 0.5mm.
- > A patented ratchet thimble mechanism helps ensure repeatability.
- > Function-lock system prevents inadvertent setting changes.
- > Long battery life – 2.4 years under normal operation.
- > Certificate of inspection provided.



293-180-30



MeasurLink ENABLED
Data Management Software by Mitutoyo

COOLANT PROOF™

Order No.	Range	Resolution	List	Promo
fit 293-180-30*	0-1"/0 - 25.4mm	.00005"/0.001mm	\$270.00	\$256.50
293-185-30	0-1"/0 - 25.4mm	.00005"/0.001mm	\$233.00	\$221.35
fit 293-181-30*	1-2"/25.4 - 50.8mm	.00005"/0.001mm	\$309.00	\$293.55
293-186-30	1-2"/25.4 - 50.8mm	.00005"/0.001mm	\$266.00	\$252.70
fit 293-182-30*	2-3"/50.8 - 76.2mm	.00005"/0.001mm	\$369.00	\$350.55
293-187-30	2-3"/50.8 - 76.2mm	.00005"/0.001mm	\$319.00	\$303.05
fit 293-183-30*	3-4"/76.2 - 101.6mm	.00005"/0.001mm	\$397.00	\$377.15
293-188-30	3-4"/76.2 - 101.6mm	.00005"/0.001mm	\$383.00	\$363.85

*with SPC Output

fit U-Wave Fit compatible

SPC cable with data switch – 1m: 05CZA662 2m: 05CZA663

COMPATIBLE WITH **U-WAVE fit**



www.mitutoyo.com/qm4x
VIDEO DEMO

Digimatic Micrometer

- > New electromagnetic ABSOLUTE sensor - Improved resistance to environmental conditions such as dirt, oil and water, which can cause false readings.
- > New ratchet thimble on select models improves one-hand operability.
- > New anti-slip finish for improved grip while taking measurements.
- > Long battery life – 2.4 years under normal operation.
- > Fully compatible with existing Mitutoyo Digimatic peripherals (SPC Cables, U-Wave wireless transmitters, DP1-VA, etc.) – SPC output-enabled IP65 models.
- > Function-lock system prevents inadvertent setting changes.
- > Certificate of inspection provided.



www.mitutoyo.com/MDC
VIDEO DEMO

COOLANT PROOF™



MeasurLink™ ENABLED
Data Management Software by Mitutoyo

Order No.	Range	Resolution	Remarks	List	Promo
fit 293-330-30*	0-1" / 0-25.4mm	.00005" / 0.001mm	Ratchet Stop	\$247.00	\$234.65
293-340-30	0-1" / 0-25.4mm	.00005" / 0.001mm	Ratchet Stop	\$193.00	\$183.35
293-344-30	0-1" / 0-25.4mm	.00005" / 0.001mm	Ratchet Thimble	\$193.00	\$183.35
293-349-30	0-1" / 0-25.4mm	.0001" / 0.001mm	Ratchet Thimble, tenths reading	\$193.00	\$183.35
fit 293-331-30*	1-2" / 25.4-50.8mm	.00005" / 0.001mm	Ratchet Stop w/Standard	\$291.00	\$276.45
293-341-30	1-2" / 25.4-50.8mm	.00005" / 0.001mm	Ratchet Stop w/Standard	\$250.00	\$237.50
293-345-30	1-2" / 25.4-50.8mm	.00005" / 0.001mm	Ratchet Thimble w/Standard	\$250.00	\$237.50
293-334-30	0-1" / -25.4mm	.00005" / 0.001mm	Ratchet Thimble	\$265.00	\$251.75
293-335-30	0-1" / -25.4mm	.00005" / 0.001mm	Friction Thimble	\$247.00	\$234.65

*with SPC Output

fit U-Wave Fit compatible

SPC cable with data switch – 1m: **05CZA662** 2m: **05CZA663**



MDC-Lite Micrometer

- > Provided only with zero set and in/mm (inch/metric models only) keys.
- > A ratchet stop or friction thimble for a constant measuring force.
- > Measurement readout with large characters on the LCD.
- > No spindle clamp. No data output.

Order No.	Range	Resolution	Remarks	List	Promo
293-831-30	0 - 1" / 0 - 25.4mm	.00005" / 0.001mm	Ratchet Stop	\$155.00	\$147.25
293-832-30	0 - 1" / 0 - 25.4mm	.00005" / 0.001mm	Friction Thimble	\$165.00	\$156.75



Spline Micrometer

- > The anvil and spindle have a small diameter for measuring splined shafts, slots and keyways.
- > With SPC output
- > Resolution: .00005" / 0.001mm
- > Large sizes available

MeasurLink™ ENABLED
Data Management Software by Mitutoyo



Order No.	Range	Accuracy	Contacts	List	Promo
fit 331-351-30	0 - 1" / 0 - 25.4mm	±.0001"	Ø.118"	\$484.00	\$459.80
fit 331-361-30		±.0001"	Ø.079"	\$484.00	\$459.80

fit U-Wave Fit compatible

SPC cable with data switch – 1m: **05CZA662** 2m: **05CZA663**

Spherical Face Micrometer

- > Designed to measure the wall thickness of various tubing.
- > Resolution: .00005" / 0.001mm
- > With SPC output.
- > Includes a standard bar except for 0 - 1" model
- > Large sizes available



MeasurLink™ ENABLED
Data Management Software by Mitutoyo

Order No.	Range	Accuracy	Min ID	List	Promo
fit 395-371-30 ^S	0 - 1" / 0 - 25.4mm	±.0001"	D: .59"	\$422.00	\$400.90
fit 395-372-30 ^S	1" - 2" / 25.4 - 50.8mm	±.0001"	D: .59"	\$448.00	\$425.60
fit 395-351-30 ^{SF}	0 - 1" / 0 - 25.4mm	±.0001"	D: .59"	\$409.00	\$388.55
fit 395-352-30 ^{SF}	1" - 2" / 25.4 - 50.8mm	±.0001"	D: .59"	\$438.00	\$416.10

S-F: Spherical anvil and flat spindle
S-S: Spherical anvil and spherical spindle

SPC cable with data switch – 1m: **05CZA662** 2m: **05CZA663**

fit U-Wave Fit compatible

www.mitutoyo.com

Point Micrometer

- > Pointed spindle and anvil for measuring the web thickness of drills, small grooves, keyways and other hard-to-reach dimensions.
- > The measuring points have approximately 0.3mm / .012" radius.
- > Includes a standard bar except for 0-1" model
- > Resolution: .00005"/0.001mm (digital models)
- > With SPC output.
- > With carbide tips.

MeasurLink ENABLED
Data Management Software by Mitutoyo

IP65 SPC



342-351-30



Digital

Order No.	Range	Accuracy	Point	List	Promo
fit 342-351-30	0 - 1" / 0 - 25.4mm	±.0001"	15°	\$476.00	\$452.20
fit 342-361-30	0 - 25.4mm	±.0001"	30°	\$476.00	\$452.20
fit 342-352-30	1" - 2" / 25.4 - 50.8mm	±.0001"	15°	\$530.00	\$503.50
fit 342-362-30	25.4 - 50.8mm	±.0001"	30°	\$519.00	\$493.05

fit U-Wave Fit compatible

SPC cable with data switch - 1m: **05CZA662** 2m: **05CZA663**

Outside Micrometer with Interchangeable Anvils

- > Large-range micrometers have an oversize frame and multiple anvils to allow a single micrometer to be used over a 6" range. This reduces tool cost for infrequently measured ranges.
- > Wide measuring range with interchangeable anvils.
- > Supplied with zero-setting standards bar for each range.

MeasurLink ENABLED
Data Management Software by Mitutoyo

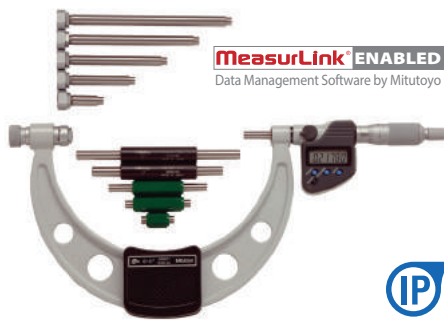

IP65 SPC

Order No.	Range	Resolution	List	Promo
340-351-30	0-6" / 0-152.4mm	.00005" / 0.001mm	\$754.00	\$716.30
340-352-30	6-12" / 152.4 - 304.8mm	.0001" / 0.001mm	\$927.00	\$880.65
340-720*	12-18" / 304.8 - 457.2mm	.0001" / 0.001mm	\$1,160.00	\$1,102.00
340-721*	18-24" / 457.2 - 609.6mm	.0001" / 0.001mm	\$1,320.00	\$1,254.00
340-722*	24-30" / 609.6 - 762.0mm	.0001" / 0.001mm	\$1,460.00	\$1,387.00
340-723*	30-36" / 762.0 - 914.4mm	.0001" / 0.001mm	\$1,550.00	\$1,472.50

SPC cable with data switch - 1m: **05CZA662** 2m: **05CZA663**

* 1m: **959149** 2m: **959150**

Tube Micrometer

- > Used to measure the wall thickness on tubing, pipe and other hard-to-reach places. Spherical or cylindrical anvils are available.
- > IP65 water/dust protection
- > With SPC output.



Type B



Type C

Type D

MeasurLink ENABLED
Data Management Software by Mitutoyo



395-363-30

Anvil Type C



IP65 SPC

Digital

Order No.	Range	Resolution	Accuracy	Type	List	Promo
fit 395-362-30	0 - 1" / 0 - 25.4mm	.00005" / 0.001mm	±.00015"	B	\$451.00	\$428.45
fit 395-363-30	0 - 25.4mm	0.001mm	±.00015"	C	\$465.00	\$441.75
fit 395-364-30				D	\$465.00	\$441.75

fit U-Wave Fit compatible

SPC cable with data switch - 1m: **05CZA662** 2m: **05CZA663**

Bore Gages

- > Carbide-tipped contact points for durability.
- > The dial indicator is fully protected by a rugged cover.
- > Optional extension rods can be attached for measuring deep holes.



See Digimatic indicators made specifically for bore gages (page 13)

10% OFF



511-751

Order No.	Range	Anvils	Spacers	List	Promo
511-751	.7 - 1.4"	9	2	\$423.00	\$380.70
511-752	1.4 - 2.5"	6	4	\$413.00	\$371.70
511-753	2.0 - 6.0"	11 (2" sub anvil)	4	\$451.00	\$405.90
511-754	4.0 - 6.5"	13	4	\$596.00	\$536.40
511-755	6.5 - 10"	6	7	\$672.00	\$604.80
511-756	10 - 16"	5 (3" sub anvil)	7	\$799.00	\$719.10

Coolant-Proof Calipers

- > Sealed housing is IP-67 rated, meaning it's immune to the coolants, dirt, grit and chips found in many manufacturing environments.
- > Easy to use - no need to wipe or clean the scale.
- > .0005"/0.01mm resolution with ± 0.001 " accuracy.
- > Automatic power-on/off.
- > Certificate of inspection provided.



COMPATIBLE WITH
U-WAVE fit

MeasurLink ENABLED
Data Management Software by Mitutoyo

Order No.	Range	List	Promo
Non-Output Style			
500-752-20	0-6"/0-150mm	\$215.00	\$204.25
500-753-20	0-8"/0-200mm	\$288.00	\$273.60
500-754-20*	0-12"/0-300mm	\$499.00	\$474.05
SPC Output Style			
fit 500-762-20	0-6"/0-150mm	\$255.00	\$242.25
fit 500-763-20	0-8"/0-200mm	\$321.00	\$304.95
fit 500-764-20*	0-12"/0-300mm	\$553.00	\$525.35

* ± 0.0015 " accuracy **fit** U-Wave Fit compatible SPC cable - 1m: **05CZA624** 2m: **05CZA625**



COOLANT PROOF™ IP67

COOLANTPROOF is the universal term of Mitutoyo Digimatic Small Tool Instruments that are free from measurement error and physical deterioration due to routine exposure to water, cutting oil or coolant. This high performance is achieved by using encoders that are inherently immune to contamination, where exposure is inevitable, combined with comprehensive sealing techniques and extremely oil-resistant materials to guarantee a long working life under normal operating conditions.

Digimatic Carbon Fiber Caliper



552-314-10



MeasurLink ENABLED
Data Management Software by Mitutoyo

Order No.	Range	Accuracy	Resolution	List	Promo
552-312-10	0(.5")-18"	± 0.002 "	.0005"/0.01mm	\$975.00	\$926.25
552-313-10	0(.5")-24"	± 0.002 "	.0005"/0.01mm	\$1,090.00	\$1,035.50
552-314-10	0(1")-40"	± 0.002 "	.0005"/0.01mm	\$1,950.00	\$1,852.50
552-315-10	0(1")-60"	± 0.004 "	.0005"/0.01mm	\$2,330.00	\$2,213.50
552-316-10	0(1")-80"	± 0.005 "	.0005"/0.01mm	\$3,650.00	\$3,467.50

SPC cable - 1m: **05CZA624** 2m: **05CZA625**

- > Lightweight Digimatic Calipers that employ CFRP (Carbon Fiber Reinforced Plastics) in the beam and jaws.
- > Highly durable and easy to handle.
- > Direct readout of ID measurements from the LCD. (Offset value can be set easily by pressing the Offset key.)
- > Preset function for setting a desired starting point.
- > With SPC data output.
- > Special models available with ceramic jaws which are suitable for measuring abrasive and magnetic products.
- > Can be used in workshop conditions exposed to coolant, water, dust or oil.
- > Incorporates ABSOLUTE measurement system.
- > Automatic power-on/off.

CERA Caliper Checker

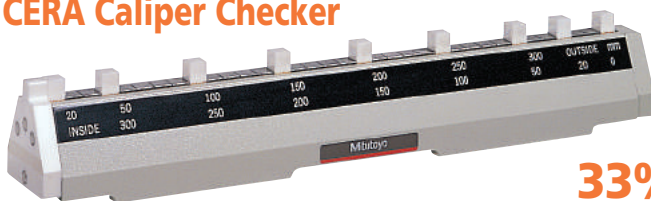

33% OFF

Order No.	Range	Remarks (length to check)	List	Promo
515-565	0 - 12"	Outside measurement: 1", 2", 4", 6", 8", 10", 12" Inside measurement: 1", 2", 4", 6", 8", 10", 12"	\$4,520.00	\$2,999.00

CERA Caliper Checker

- > Permanently wrung, high grade CERA gage blocks in a protective metal casing.
- > Stands perpendicular for height gage inspection.
- * Also includes same features as CERA Gage Blocks

CERA (Zirconia Ceramic) Gage Blocks*

- > Extremely high wear resistance, 3x better than carbide.
- > Corrosion proof - no oil needed.
- > Closest expansion coefficient to steel.
- > Anti-magnetic - keeps away steel dust.
- > High wringing force due to high density.
- > Crack and burr resistant.
- > Low thermal conductivity - excellent dimensional stability under brief temperature changes (from handling, etc.).

Digimatic Calipers

- > AOS Electromagnetic inductive sensor improves environmental resistance against dirt, water and oil.
- > A battery life of approximately 3.5 years has been achieved under normal use through the adoption of Mitutoyo's ABSOLUTE scale.
- > The slider configuration features an ergonomic, thumb-friendly shape.
- > Step-measurement capable.
- > The data output function allows integration into Statistical Process Control and measurement systems.
- > Display character height: 9mm
- > AOS applies to 4", 6" and 8" models
- > Resolution: .0005"/0.01mm

MeasurLink ENABLED
Data Management Software by Mitutoyo



www.mitutoyo.com/aoscd
VIDEO DEMO

COMPATIBLE WITH
U-WAVE fit



500-171-30



ABSOLUTE
Absolute System Powered by MITUTOYO

ABSOLUTE AOS DIGIMATIC

AOS: Advanced Onsite Sensor

Order No.	Range	Remarks	List	Promo
No SPC Output Style				
500-195-30	0-4"/0-100mm	.075" round depth bar	\$148.00	\$140.60
500-196-30	0-6"/0-150mm		\$161.00	\$152.95
500-197-30	0-8"/0-200mm		\$231.00	\$219.45
500-193-30	0-12"/0-300mm		\$464.00	\$440.80
With SPC Output Style				
fit 500-170-30	0-4"/0-100mm	.075" round depth bar	\$177.00	\$168.15
fit 500-171-30	0-6"/0-150mm		\$188.00	\$178.60
fit 500-172-30	0-8"/0-200mm		\$248.00	\$235.60
fit 500-173-30	0-12"/0-300mm		\$541.00	\$513.95
500-505-10	0-18"/0-450mm	without thumb roller	\$844.00	\$801.80
500-506-10	0-24"/0-600mm	without thumb roller	\$927.00	\$880.65
500-507-10	0-40"/0-1000mm	without thumb roller	\$1,790.00	\$1,700.50

fit U-Wave Fit compatible

SPC cable with data switch - 1m: 959149 2m: 959150

Dial Caliper

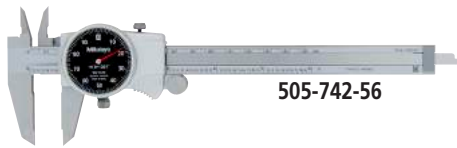

505-742-56

- > Smooth sliding with high shock protection.
- > Lock screw for dial bezel and for holding the sliding jaw position.
- > Can measure OD, ID, depth and steps.
- > Models available with carbide-tipped OD and ID jaws.

Order No.	Range	Remarks	List	Promo
505-742	0 - 6" .100"/rev		\$125.00	\$118.75
505-738	0 - 6" .100"/rev	carbide-tipped jaws	\$213.00	\$202.35
505-740	0 - 6" .200"/rev		\$114.00	\$108.30
505-743	0 - 8" .100"/rev		\$182.00	\$172.90
505-746	0 - 12" .100/rev		\$289.00	\$274.55
505-749	0 - 12" .200/rev		\$269.00	\$255.55
505-742-56	0 - 6" .100"/rev	black dial face	\$125.00	\$118.75

Prices effective June 1 through August 31, 2020

Offset Caliper

- > Main scale jaw can slide up and down to facilitate measurement of stepped sections. (Hard-to-reach dimensions such as A, B, C can be accurately measured.)
- > With depth bar.
- > With SPC data output.

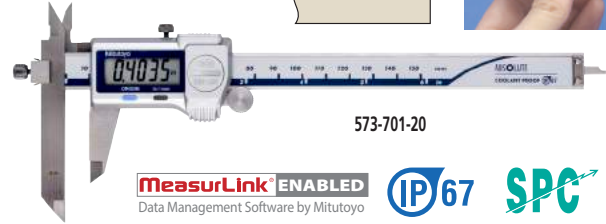
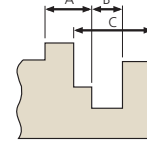

573-701-20

MeasurLink ENABLED
Data Management Software by Mitutoyo



ABSOLUTE
Absolute System Powered by MITUTOYO

Order No.	Range	Accuracy	Resolution	List	Promo
fit 573-701-20	0 - 6" / 0 - 150mm	±.001"	.0005" / 0.01mm	\$478.00	\$454.10
fit 573-702-20	0 - 8" / 0 - 200mm	±.001"	.0005" / 0.01mm	\$548.00	\$520.60
fit 573-704	0 - 12" / 0 - 300mm	±.0015"	.0005" / 0.01mm	\$735.00	\$698.25

fit U-Wave Fit compatible SPC cable with data switch - 1m: 05CZA624 2m: 05CZA625

Point Caliper

- > Narrow tip jaws fit into very small grooves and tracks, making many previously difficult outside measurements easier to obtain.
- > With depth bar.
- > With SPC data output.

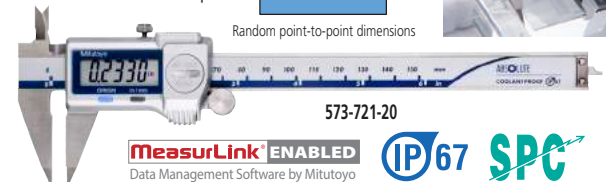
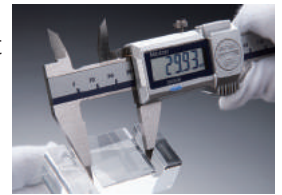
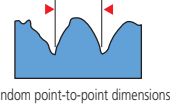

573-721-20

MeasurLink ENABLED
Data Management Software by Mitutoyo



ABSOLUTE
Absolute System Powered by MITUTOYO

Order No.	Range	Accuracy	Resolution	List	Promo
fit 573-721-20	0 - 6" / 0 - 150mm	±.001"	.0005" / 0.01mm	\$419.00	\$398.05
fit 573-725-20*	0 - 6" / 0 - 150mm	±.001"	.0005" / 0.01mm	\$520.00	\$494.00

* Extended tips **fit** U-Wave Fit compatible SPC cable with data switch - 1m: 05CZA624 2m: 05CZA625

Low-Force Caliper

- > Due to the low measuring force, these calipers are ideal for elastic or resilient workpieces such as plastic parts and rubber parts that standard calipers can't measure consistently.
- > With SPC data output.



573-291-30

MeasurLink ENABLED
Data Management Software by Mitutoyo



Order No.	Range	Accuracy	Resolution	List	Promo
fit 573-291-30	0 - 7" / 0 - 180mm	±.002"	.0005" / 0.01mm	\$845.00	\$802.75

fit U-Wave Fit compatible

Digimatic Caliper with Nib-Style Jaws

- > The rounded faces of the jaws are ideal for accurate ID (inside diameter) measurement.
- > With SPC output.

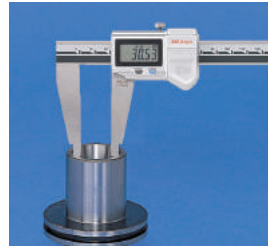

MeasurLink ENABLED
Data Management Software by Mitutoyo

IP67 **SPC** **ABSOLUTE**
Absolute System Powered by MITUTOYO

SPC cable with data switch – 1m: **05CZA624** 2m: **05CZA625**

Order No.	Range*	Accuracy	Resolution	List	Promo
fit 550-311-20	0 (.4") - 8" / 0 (10) - 200mm	±.001"	.0005" / 0.01mm	\$541.00	\$513.95
fit 550-341-10	0 (.4") - 12" / 0 (10) - 300mm	±.0015"	.0005" / 0.01mm	\$786.00	\$746.70
550-223-10**	0 (.5") - 18" / 0 (20) - 450mm	±.002"	.0005" / 0.01mm	\$985.00	\$935.75
550-225-10**	0 (.5") - 24" / 0 (20) - 600mm	±.002"	.0005" / 0.01mm	\$1,100.00	\$1,045.00
550-227-10**	0 (1") - 40" / 0 (20) - 1000mm	±.003"	.0005" / 0.01mm	\$1,970.00	\$1,871.50

* (): Minimum dimension in ID measurement **Models are not IP67 rated **fit** U-Wave Fit compatible

Digimatic Caliper with Nib and Standard Jaws

- > The rounded faces of the jaws are ideal for accurate ID (inside diameter) measurement.
- > With SPC output.

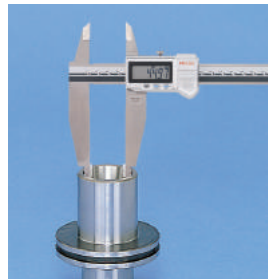

MeasurLink ENABLED
Data Management Software by Mitutoyo

IP67 **SPC**

SPC cable with data switch – 1m: **05CZA624** 2m: **05CZA625**

Order No.	Range*	Accuracy	Resolution	List	Promo
fit 551-311-20	0 (.4") - 8" / 0 (10) - 200mm	±.001"	.0005" / 0.01mm	\$596.00	\$566.20
fit 551-341-10	0 (.4") - 12" / 0 (10) - 300mm	±.002"	.0005" / 0.01mm	\$854.00	\$811.30
551-224-10**	0 (.5") - 20" / 0 (20) - 500mm	±.0025"	.0005" / 0.01mm	\$1,260.00	\$1,197.00
551-226-10**	0 (.5") - 30" / 0 (20) - 750mm	±.0025"	.0005" / 0.01mm	\$2,040.00	\$1,938.00

* (): Minimum dimension in ID measurement **fit** U-Wave Fit compatible
** Models are not IP67 rated

Inside Calipers Knife-Edge/Inside Groove/Point Jaw

- > Special ID jaw calipers are designed for difficult-to-measure areas, such as ID grooves or recessed areas.
- > With SPC data output.

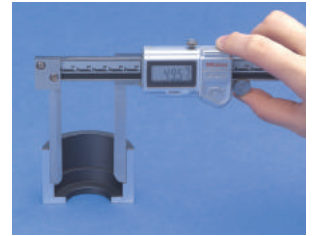

IP67 **SPC** **ABSOLUTE**
Absolute System Powered by MITUTOYO

MeasurLink ENABLED
Data Management Software by Mitutoyo

Knife edge



Measurable min. hole diameter: ϕ .4"

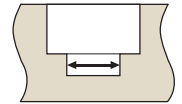

Inside groove



Measurable min. hole diameter: ϕ .4"

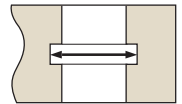

Point jaw



Measurable min. hole diameter: ϕ .8"

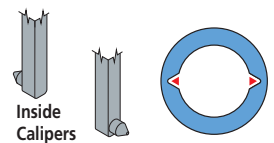
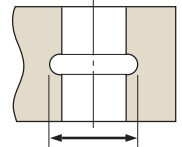

Order No.	Range	Accuracy	List	Promo
573-742-20	.4" - 8" / 10-200mm	±.002"	\$937.00	\$890.15
fit 573-745-20	.4" - 6" / 10-150mm	±.002"	\$749.00	\$711.55
fit 573-746-20	.8" - 6" / 20-150mm	±.0015"	\$909.00	\$863.55

fit U-Wave Fit compatible

SPC cable with data switch – 1m: **05CZA624** 2m: **05CZA625**

www.mitutoyo.com

Dial Test Indicators



Standard

NEW .000050" / 50µinch model now available!

- > One-piece movement assembly for improved durability & impact resistance.
- > Contact point length shown on dial face.
- > Certificate of Inspection included.
- > shows results from both measuring directions.
- > Resilient crystal with high resistance to glare, scratches and impact.



Contact point length is printed on dial face to avoid accuracy issues

Part #	Range	Graduations	Set Type	Face Color	List	Promo	Remarks
Standard							
513-407-10E	.008"	.00005"	Basic	White	\$192.00	\$172.80	NEW
513-407-10T	.008"	.00005"	Full	White	\$225.00	\$202.50	NEW
513-401-10E	.14"	0.001mm	Basic	Yellow	\$228.00	\$205.20	
513-402-10E	.03"	.0005"	Basic	White	\$134.00	\$120.60	
513-402-10T	.03"	.0005"	Full	White	\$159.00	\$143.10	
513-403-10E	.008"	.0001"	Basic	White	\$174.00	\$156.60	
513-403-10T	.008"	.0001"	Full	White	\$204.00	\$183.60	
513-404-10E	0.8mm	0.01mm	Basic	Yellow	\$136.00	\$122.40	
513-404-10A	0.8mm	0.01mm	Plus	Yellow	\$149.00	\$134.10	
513-404-10T	0.8mm	0.01mm	Full	Yellow	\$160.00	\$144.00	
513-405-10E	0.2mm	0.002mm	Basic	Yellow	\$150.00	\$135.00	
513-405-10T	0.2mm	0.002mm	Full	Yellow	\$197.00	\$177.30	
513-406-10E	.03"/0.7mm	.0005"/0.01mm	Basic	White/Yellow	\$157.00	\$141.30	Dual dial
513-406-10T	.03"/0.7mm	.0005"/0.01mm	Full	White/Yellow	\$174.00	\$156.60	Dual dial
513-409-10E	0.2mm/.0076"	0.002mm/.0001"	Basic	Yellow/White	\$202.00	\$181.80	Dual dial
513-409-10T	0.2mm/.0076"	0.002mm/.0001"	Full	Yellow/White	\$205.00	\$184.50	Dual dial
513-412-10E	.03"	.0005"	Basic	White	\$192.00	\$172.80	
513-412-10T	.03"	.0005"	Full	White	\$221.00	\$198.90	
513-415-10E	1.0mm	0.01mm	Basic	Yellow	\$144.00	\$129.60	Long stylus
513-415-10H	1.0mm	0.01mm	Basic	Yellow	\$158.00	\$142.20	Long stylus
Ruby Tip							
513-472-10E	.03"	.0005"	Basic	White	\$149.00	\$134.10	
513-479-10E	.03"	.0005"	Basic	White	\$158.00	\$142.20	Long stylus
Standard (20° tilted face)							
513-442-10A	.06"	.0005"	Basic	White	\$181.00	\$162.90	
513-442-10T	.06"	.0005"	Full	White	\$205.00	\$184.50	
513-442-16A	.06"	.0005"	Basic	Black	\$181.00	\$162.90	
513-442-16T	.06"	.0005"	Full	Black	\$205.00	\$184.50	
513-446-16A	.06"	.0005"	Basic	Black	\$242.00	\$217.80	Long stylus
513-446-16T	.06"	.0005"	Full	Black	\$273.00	\$245.70	Long stylus
513-446-10A	.06"	.0005"	Basic	White	\$242.00	\$217.80	Long stylus
513-446-10T	.06"	.0005"	Full	White	\$273.00	\$245.70	Long stylus
513-443-10A	.016"	.0001"	Basic	White	\$228.00	\$205.20	
513-443-10T	.016"	.0001"	Full	White	\$259.00	\$233.10	
Vertical: dial is on the top of the frame							
513-452-10E	.03"	.0005"	Basic	White	\$174.00	\$156.60	
513-452-10T	.03"	.0005"	Full	White	\$192.00	\$172.80	
513-453-10E	.008"	.0001"	Basic	White	\$207.00	\$186.30	
Parallel: dial is on the side of the frame							
513-485-10E	0.2mm	0.002mm	Basic	Yellow	\$221.00	\$198.90	

Set Configuration

Inch

Full set

Contact point, .039" DIA. carbide
 Contact point, .118" DIA. carbide
 Stem, .157" DIA. (21CAB106)
 Swivel clamp (900322, for .157" DIA., 3/8" DIA., dovetail)
 Inch holding bar (L: 4") (900306)

Basic set

Contact point, .079" DIA. (Carbide)
 Indicator
 Knurled clamp ring
 Stem, .157" DIA. (21CAB106)
 Stem, 3/8" DIA.

T set

E, A set

Metric

Full set

Swivel clamp (900321, for ø4mm, ø8mm, dovetail)
 Metric holding bar (L: 100mm) (900209)

Plus set

Contact point, ø1mm carbide
 Contact point, ø3mm carbide
 Stem, ø4mm (21CAB106)

Basic set

Contact point, ø2mm (Carbide)
 Indicator
 Knurled clamp ring
 Stem, ø8mm (Set No. 902804)

T set

A set

C set (ø 6 Stem)

E set

H set (ø 6 Stem)

Prices effective June 1 through August 31, 2020

Calculation-Type Digimatic Indicator ID-C

- > The ABSOLUTE Digimatic indicator performs internal calculations using the formula $Ax+B+Cx-1$ (assuming spindle displacement as x), while the specified coefficients A, B and C can be set with respect to the purpose of measurement or dimensions of the fixtures. This unique feature allows for reading measurements directly, without searching for conversions.
- > Calculation-Type Digimatic Indicator features both a key lock and parameter lock.
- > Fast measurement frequency up to 50 per second.
- > An analog bar provides easy-to-read values when scanning for Max, Min and TIR Values.

- > Improved parameter setting software makes it even easier to set all of the available parameters and determine and upload the proper coefficients for calculation. (optional) **21EZA313**



MeasurLink ENABLED
Data Management Software by Mitutoyo



www.mitutoyo.com/idccal
VIDEO DEMO

10% OFF



ABSOLUTE

Stem dia. 3/8" #4-48 UNF Thread

Order No.	Resolution	Range	Accuracy	Measuring Force	List	Promo
543-342B	.00005/.0001/.0005"	.5"/12.7mm	±.00010"/0.003mm	1.5N or less	\$458.00	\$412.20
543-592B	(0.001/0.01mm)	1"/25.4mm	±.00010"/0.003mm	1.8N or less	\$614.00	\$552.60
543-597B	Selectable	2"/50.8mm	±.00025"/0.006mm	2.3N or less	\$770.00	\$693.00

SPC cable – 1m: **905338** 2m: **905409**

Bore Gage ABSOLUTE Digimatic Indicator ID-C



Installed on optional bore gage probe (page 8)

- > Hold automatically picks up hole diameter after a sweep.
- > Bore Gage Digimatic Indicator features both a key lock and parameter lock.
- > Fast measurement frequency up to 50 per second.
- > An analog bar indicator is integrated to enhance the intuition in reading.
- > Up to three sets of master values and upper/lower tolerance values can be memorized.

- > Go/no-go judgment
- > Employing the ABSOLUTE linear encoder, the ID-C always displays the spindle Absolute Position from the origin at power-on.
- > Improved parameter setting software makes it even easier to set all of the available parameters and determine and upload the proper coefficients for calculation. (optional) **21EZA313**

MeasurLink ENABLED
Data Management Software by Mitutoyo

10% OFF



ABSOLUTE

Order No.	Resolution	Range	Accuracy	Measuring Force	List	Promo
543-312B	.00005/.0001/.0005"	.5"/12.7mm	±.00010"/0.003mm	1.5N or less	\$458.00	\$412.20
	(0.001/0.01mm)	Selectable				

SPC cable – 1m: **905338** 2m: **905409**

Peak Hold ABSOLUTE Digimatic Indicator ID-C

With Max./Min. Value Holding Function

- > Peak Hold Digimatic Indicator features both a Key Lock and Parameter Lock.
- > An analog bar provides easy-to-read values when scanning for Max, Min and TIR Values.
- > Go/no-go judgment
- > The maximum, minimum or runout value can be displayed during measurement.

- > Fast measurement frequency up to 50 per second.
- > Employing the ABSOLUTE linear encoder, the Signal ID-C always displays the spindle Absolute Position from the origin at power-on.
- > Improved parameter setting software makes it even easier to set all of the available parameters and determine and upload the proper coefficients for calculation. (optional) **21EZA313**

MeasurLink ENABLED
Data Management Software by Mitutoyo

10% OFF



ABSOLUTE

Order No.	Resolution	Range	Accuracy	Remarks	List	Promo
Stem dia. 3/8", #4-48 UNF Thread						
543-302	.00005/.0001/.0005"	.5"/12.7mm	±.00010"/0.003mm	w/lug	\$458.00	\$412.20
543-302B	(0.001/0.01mm)	.5"/12.7mm	±.00010"/0.003mm	Flat-back	\$458.00	\$412.20
	Selectable					

SPC cable – 1m: **905338** 2m: **905409**

www.mitutoyo.com

ABSOLUTE Digimatic Indicator ID-S

- > Employing the ABSOLUTE linear encoder, the ID-S always displays the spindle Absolute Position from the origin at power-on. Also, unlimited response speed eliminates overspeed errors.
- > Dust/Water protection level: IP42 (IP53: **543-795B, 543-796B**)
- > SPC data output.



Order No.	Resolution	Range	Accuracy	Measuring force	Remarks	List	Promo
Stem dia. 3/8", #4-48 UNF Thread							
543-792	.00005"/0.001mm	.5" / 12.7mm	±.0001"	1.5N or less	w/ lug back	\$281.00	\$266.95
543-796	.00005"/0.001mm	.5" / 12.7mm	±.0001"	2.5N or less	w/ lug back	\$310.00	\$294.50
543-793	.0001"/0.001mm	.5" / 12.7mm	±.0001"	1.5N or less	w/ lug back	\$281.00	\$266.95
543-783	.0005"/0.01mm	.5" / 12.7mm	±.0010"	1.5N or less	w/ lug back	\$182.00	\$172.90
543-792B	.00005"/0.001mm	.5" / 12.7mm	±.0001"	1.5N or less	w/ flat-back	\$281.00	\$266.95
543-796B	.00005"/0.001mm	.5" / 12.7mm	±.0001"	2.5N or less	w/ flat-back	\$310.00	\$294.50
543-793B	.0001"/0.001mm	.5" / 12.7mm	±.0001"	1.5N or less	w/ flat-back	\$281.00	\$266.95
543-783B	.0005"/0.01mm	.5" / 12.7mm	±.0010"	1.5N or less	w/ flat-back	\$182.00	\$172.90
Stem ø 8mm, M2.5 x 0.45 Thread							
543-791	.00005"/0.001mm	.5" / 12.7mm	±.0001"	1.5N or less	w/ lug back	\$290.00	\$275.50
543-795	.00005"/0.001mm	.5" / 12.7mm	±.0001"	2.5N or less	w/ lug back	\$319.00	\$303.05
543-782	.0005"/0.01mm	.5" / 12.7mm	±.001"	1.5N or less	w/ lug back	\$182.00	\$172.90
543-791B	.00005"/0.001mm	.5" / 12.7mm	±.0001"	1.5N or less	w/ flat-back	\$290.00	\$275.50
543-795B	.00005"/0.001mm	.5" / 12.7mm	±.0001"	2.5N or less	w/ flat-back	\$319.00	\$303.05
543-782B	.0005"/0.01mm	.5" / 12.7mm	±.001"	1.5N or less	w/ flat-back	\$182.00	\$172.90

SPC cable – 1m: 905338 2m: 905409

ID-C Digimatic Indicators

- > Absolute Encoder ensures all settings and readings maintained for the life of the battery (even when the power is turned off).
- > Preset, zero set, inch/mm, +/- direction and go/no-go functions.
- > Face rotates 330° for use at various angles.
- > Stem diameter: 3/8".
- > Protected from overspeed errors.
- > SPC output provided.
- > Average battery life 7,000 hours using SR-44 battery (938882).



Now with multiplier function $f(x)=Ax$ (other models available with $Ax+B+Cx-1$ function; see page 13)

Order No.	Range	Remarks	List	Promo
.0005"/0.01mm Resolution				
543-402	.500"/12.7mm	lug back	\$319.00	\$303.05
543-402B	.500"/12.7mm	flat back	\$319.00	\$303.05
543-476B	1"/25mm	flat back	\$468.00	\$444.60
543-496B	2"/50mm	flat back	\$615.00	\$584.25
.00005"/.0001"/.0005"/0.001mm/0.01mm selectable resolutions				
543-392	.500"/12.7mm	lug back	\$437.00	\$415.15
543-392B	.500"/12.7mm	flat back	\$437.00	\$415.15
543-472B	1"/25mm	flat back	\$585.00	\$555.75
543-492B	2"/50mm	flat back	\$734.00	\$697.30

SPC cable – 1m: 905338 2m: 905409

Prices effective June 1 through August 31, 2020

Digimatic Indicator ID-H

Remote Programming Capable

> This digital indicator offers the excellent accuracy and functionality expected from this class of indicator. Take advantage of its high accuracy backed up by 0.5µm / .00002" resolution, remote control functionality via a handheld controller (or an RS-232C interface) and easy runout measurements with the well-established analog bar display.

> The maximum, minimum or runout value can be displayed during measurement.
 > Go/no-go judgment is performed by setting the upper and lower tolerances. If a judgment result is out of tolerance, the display backlighting changes from green to red, so tolerance judgment can be made at a glance.
 > With RS-232C input/output

Stem dia. 3/8" #4-48 UNF Thread

Order No.	Resolution	Range	Model	Accuracy	List	Promo
543-562A	.00002", .00005", .0001", 0.0005mm, 0.001mm	1.2" / 30.4mm	ID-H530E	0.0015mm	\$909.00	\$818.10
543-564A	0.001mm	2.4" / 60.9mm	ID-H560E	0.0025mm	\$1,080.00	\$972.00

SPC cable – 1m: 936937 2m: 965014

10% OFF

21EZA099
Remote controller
(optional)



543-564A



MeasurLink ENABLED
Data Management Software by Mitutoyo

ABSOLUTE Digimatic Indicator ID-F

> With the ABSOLUTE linear encoder technology, once the measurement reference point has been preset, it will not be lost when the power is turned on.
 > Go/no-go judgment is performed by setting the upper and lower tolerances. If a judgment result is out of tolerance, the display backlighting changes from green to red, so tolerance judgment can be made at a glance.
 > The maximum, minimum or runout value can be displayed during measurement.

> An analog bar indicator has been integrated to handle upper/lower limit approaching and zero approaching. It enhances the ease of operation in the same manner as a dial indicator. The display range of the analog bar can be changed.



10% OFF



543-552A



543-558A



ABSOLUTE

MeasurLink ENABLED
Data Management Software by Mitutoyo

Stem dia. 3/8" #4-48 UNF Thread

Order No.	Resolution	Range	Model	Accuracy	List	Promo
543-552A	.00005", .0001", .0005", .001", 0.001mm, 0.01mm	1" / 25.4mm	ID-F125E	.00012"	\$687.00	\$618.30
543-558A	0.01mm	2" / 50.8mm	ID-F150HE	.00012"	\$796.00	\$716.40

SPC cable – 1m: 936937 2m: 965014

ABSOLUTE Digimatic Indicator ID-U

> Slim digital indicator with low price.
 > Large LCD and simple key operation.
 > After the initial origin setting, the ID-U no longer needs absolute positioning over the entire battery life; the origin is remembered even after power-off.
 > Ideal for installation into measuring devices because of compact design and long battery life.
 > Employing the ABSOLUTE linear encoder, the ID-U always displays the spindle Absolute Position from the origin at power-on. Also unlimited response speed eliminates overspeed errors.
 > Flat-back type has no option for backs.

10% OFF



575-123

ABSOLUTE
SPC

MeasurLink ENABLED
Data Management Software by Mitutoyo

Order No.	Resolution	Range	Model	Accuracy	Measuring force	List	Promo
575-123	.0005"/0.01mm	1" / 25.4mm	ID-U1025E	.0008"	1.8N or less	\$201.00	\$180.90

SPC cable – 1m: 905338 2m: 905409

Holtest

- > Titanium-coated measuring pins provide excellent durability and impact resistance and allows the instrument to measure close to the bottom of blind holes.
- > Three-point design ensures self-centering action for stable measurements in the range above .275" bore diameter.
- > With ratchet stop for constant force.

Holtest Type II

- > The anvils and cone are made from an alloy tool steel with a hardness of HRC60.5 or more.
- > Three-point design ensures self-centering action for stable measurements in the range above .275" bore diameter.
- > With ratchet stop for constant force.

Holtest

Holtest Type II

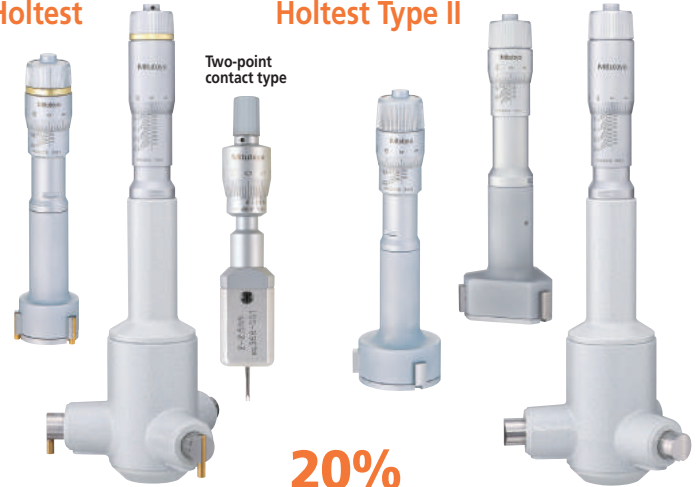

20% OFF

Mechanical Holtests – Individual Units

Order No.	Description/Range	List	Promo
368-021	Holtest, 0.08"-0.1"	\$1,500.00	\$1,200.00
368-022	Holtest, 0.1"-0.12"	\$1,500.00	\$1,200.00
368-023	Holtest, 0.12"-0.16"	\$1,210.00	\$968.00
368-024	Holtest, 0.16"-0.2"	\$1,210.00	\$968.00
368-025	Holtest, 0.2"-0.24"	\$1,210.00	\$968.00
368-026	Holtest, 0.24"-0.28"	\$1,210.00	\$968.00
368-261	Holtest, 0.275"-0.35"	\$599.00	\$479.20
368-262	Holtest, 0.35"-0.425"	\$599.00	\$479.20
368-263	Holtest, 0.425"-0.5"	\$599.00	\$479.20
368-264	Holtest, 0.5" - 0.65"	\$621.00	\$496.80
368-265	Holtest, 0.65"-0.8"	\$621.00	\$496.80
368-266	Holtest, 0.8" - 1.0"	\$645.00	\$516.00
368-267	Holtest, 1.0" - 1.2"	\$645.00	\$516.00
368-268	Holtest, 1.2" - 1.6"	\$806.00	\$644.80
368-269	Holtest, 1.6" - 2.0"	\$850.00	\$680.00
368-270	Holtest, 2.0" - 2.5"	\$855.00	\$684.00
368-271	Holtest, 2.5" - 3.0"	\$928.00	\$742.40
368-272	Holtest, 3.0" - 3.5"	\$953.00	\$762.40
368-273	Holtest, 3.5" - 4.0"	\$997.00	\$797.60
368-274	Holtest, 4.0" - 5.0"	\$1,280.00	\$1,024.00
368-275	Holtest, 5.0" - 6.0"	\$1,450.00	\$1,160.00
368-276	Holtest, 6.0" - 7.0"	\$1,490.00	\$1,192.00
368-277	Holtest, 7.0" - 8.0"	\$1,540.00	\$1,232.00
368-278	Holtest, 8.0" - 9.0"	\$1,750.00	\$1,400.00
368-279	Holtest, 9.0" - 10"	\$1,960.00	\$1,568.00
368-280	Holtest, 10" - 11"	\$1,980.00	\$1,584.00
368-281	Holtest, 11" - 12"	\$2,030.00	\$1,624.00

Mechanical Holtests – Complete Unit Sets

368-916	Holtest, Set, 0.275"-0.5"*	\$2,210.00	\$1,768.00
368-917	Holtest, Set, 0.5" - 0.8"*	\$1,490.00	\$1,192.00
368-918	Holtest, Set, 0.8" - 2.0"*	\$3,410.00	\$2,728.00
368-919	Holtest, Set, 2.0" - 4.0"*	\$4,860.00	\$3,888.00
368-920	Holtest, Set, 4.0" - 8.0"*	\$7,440.00	\$5,952.00
368-926	Holtest, 2pc Set, .08" - .12"*	\$3,190.00	\$2,552.00
368-927	Holtest, 4pc Set, .12" - .28"*	\$5,090.00	\$4,072.00
368-995	HOLTEST, SET, TYPE II, R, 0.5 - .8"	\$1,360.00	\$1,088.00
368-996	HOLTEST, SET, TYPE II, R, 0.8 - 2"	\$3,120.00	\$2,496.00
368-997	HOLTEST, SET, TYPE II, R, 2 - 4"	\$4,390.00	\$3,512.00
368-998	HOLTEST, SET, TYPE II, R, 4 - 8"	\$6,840.00	\$5,472.00

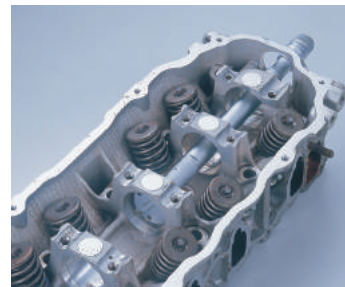

Measuring a Blind Hole

The measuring contact points held in the jaws permit measuring the diameter of a blind hole to the bottom. (up to 100mm / 4" models)

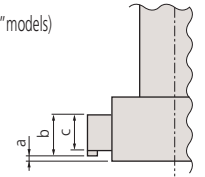

Measuring Deep Holes

An extension tube (optional accessory) can be fitted to enable measurement of deep holes.



TiN coated contact points

Range	a	b	c
6 - 12mm / .275 - .5"	2	—	2.5
12 - 20mm / .5 - .8"	0.3	5.6	3.5
20 - 30mm / .8 - 1.2"	0.3	8.3	5.2
30 - 50mm / 1.2 - 2"	0.3	13	10
50 - 100mm / 2 - 4"	0.3	17	14
100 - 300mm / 4 - 12"	12.4	21	13.8



Inspection Certificate Supplied as Standard

An Inspection Certificate is supplied with each instrument, which assures product quality and safety. On request, Mitutoyo can issue a Calibration Certificate, at a cost, from our accredited calibration laboratory.

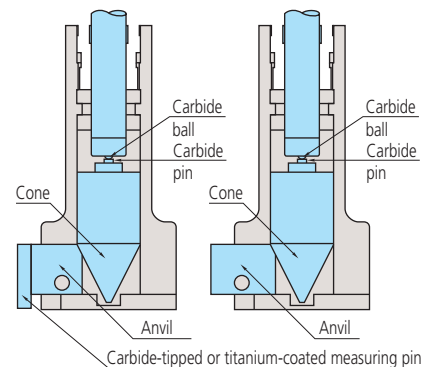

Digimatic Holtest

- > TiN-coated measuring contact points provide excellent durability and impact resistance and allows the instrument to measure close to the bottom of blind holes (up to 4"/100mm models).
- > Large LCD readout.
- > Functions available: Presetting, Zero/ABS, Auto power On/Off, Data hold, Data output, Error alarm, Battery replacement alarm.
- > With ratchet stop for constant force.
- > Measure deep holes by attaching an extension rod (optional).
- > Setting rings are included in sets, but optional for individual gages.
- > Supplied in fitted plastic case up to 4"/100mm. Over 4"/100mm supplied in wooden case.
- > Resolution: .00005"/0.001mm (over 4" models: .0001"/0.001mm)



MeasurLink[®] ENABLED
Data Management Software by Mitutoyo

20% OFF



Digimatic Holtests – Individual Units			
Order No.	Range	List	Promo
468-261	Digimatic Holtest, .275-.35"	\$1,110.00	\$888.00
468-262	Digimatic Holtest, .35"-.425"	\$1,110.00	\$888.00
468-263	Digimatic Holtest, .425-.5"	\$1,120.00	\$896.00
468-264	Digimatic Holtest, 0.5" - 0.65"	\$1,220.00	\$976.00
468-265	Digimatic Holtest, 0.65" - 0.8"	\$1,220.00	\$976.00
468-266	Digimatic Holtest, 0.8" - 1"	\$1,250.00	\$1,000.00
468-267	Digimatic Holtest, 1.0-1.2"	\$1,250.00	\$1,000.00
468-268	Digimatic Holtest, 1.2" - 1.6"	\$1,280.00	\$1,024.00
468-269	Digimatic Holtest, 1.6" - 2.0"	\$1,290.00	\$1,032.00
468-270	Digimatic Holtest, 2" - 2.5"	\$1,400.00	\$1,120.00
468-271	Digimatic Holtest, 2.5" - 3"	\$1,400.00	\$1,120.00
468-272	Digimatic Holtest, 3" - 3.5"	\$1,420.00	\$1,136.00
468-273	Digimatic Holtest, 3.5" - 4"	\$1,440.00	\$1,152.00
468-274	Digimatic Holtest, 4" - 5"	\$1,880.00	\$1,504.00
468-275	Digimatic Holtest, 5" - 6"	\$1,930.00	\$1,544.00
468-276	Digimatic Holtest, 6" - 7"	\$2,050.00	\$1,640.00
468-277	Digimatic Holtest, 7" - 8"	\$2,140.00	\$1,712.00
468-278	Digimatic Holtest, 8" - 9"	\$2,280.00	\$1,824.00
468-279	Digimatic Holtest, 9" - 10"	\$2,330.00	\$1,864.00
468-280	Digimatic Holtest, 10" - 11"	\$2,410.00	\$1,928.00
468-281	Digimatic Holtest, 11" - 12"	\$2,520.00	\$2,016.00
Digimatic Holtests – Interchangeable Head Sets			
468-976	Digimatic Holtest Head Set, 0.275"-0.5"*	\$2,030.00	\$1,624.00
468-977	Digimatic Holtest, Head Set, 0.5" - 0.8"*	\$1,650.00	\$1,320.00
468-978	Digimatic Holtest, Head Set, 0.8" - 2"*	\$4,120.00	\$3,296.00
468-979	Digimatic Holtest, Head Set, 2" - 4"*	\$4,720.00	\$3,776.00
468-980	Digimatic Holtest, Head Set, 4" - 8"*	\$5,540.00	\$4,432.00
Digimatic Holtests – Complete Unit Sets			
468-986	Digimatic Holtest, Unit-Set, 0.275"-0.5"*	\$3,960.00	\$3,168.00
468-987	Digimatic Holtest, Unit-Set, 0.5" - 1"*	\$4,200.00	\$3,360.00
468-988	Digimatic Holtest, Unit-Set, 1" - 2"*	\$4,760.00	\$3,808.00
468-989	Digimatic Holtest, Unit-Set, 2" - 3"*	\$5,350.00	\$4,280.00
468-990	Digimatic Holtest, Unit-Set, 3" - 4"*	\$6,290.00	\$5,032.00

Measuring Deep Holes

An extension rod (optional accessory) can be fitted to enable measurement of deep holes.



www.mitutoyo.com/dholtest
VIDEO DEMO



Complete-Unit Set



Interchangeable-Head Set

Borematic

Quick, spring-loaded lever action/movement

- > Titanium-coated measuring pins provide excellent durability and impact resistance and allows the instrument to measure close to the bottom of blind holes.
- > Digital display with quick-action lever operation enables quick and easy measurement.
- > Built-in ABSOLUTE System eliminates the need to set the origin point every time the unit is turned on. The system is immune to over-speed errors, thus increasing the reliability of measurement.
- > Digimatic Borematic is compatible with statistical process control systems and measurement support systems.
- > Built-in tolerance judgment function allows go/no-go judgment based on user-defined upper and lower limit settings.

SAVE 20%

MeasurLink ENABLED
Data Management Software by Mitutoyo

ABSOLUTE

SPC



Individual Gages: includes one digital display unit and one interchangeable measuring head (plus adapter if required)

Order No	Size Range	Accuracy	Extension Rod	List	Promo
568-461	0.275" - 0.350"	±5µm (within 5µm) ±0.00025 in (within 0.00025")	100mm (952322)	\$1,450.00	\$1,160.00
568-462	0.350" - 0.425"			\$1,450.00	\$1,160.00
568-463	0.425" - 0.500"			\$1,450.00	\$1,160.00
568-464	0.50" - 0.65"	±5µm (within 5µm) ±0.00025 in (within 0.00025")	150mm (952621)	\$1,480.00	\$1,184.00
568-465	0.65" - 0.80"			\$1,480.00	\$1,184.00
568-466	0.8" - 1.0"			\$1,480.00	\$1,184.00
568-467	1.0" - 1.2"		150mm (952622)	\$1,530.00	\$1,224.00
568-468	1.2" - 1.6"			\$1,700.00	\$1,360.00
568-469	1.6" - 2.0"			\$1,700.00	\$1,360.00
568-470	2.0" - 2.5"	±6µm (within 6µm) ±0.0003 in (within 0.0003")	150mm (952623)	\$1,660.00	\$1,328.00
568-471	2.5" - 3.0"			\$1,720.00	\$1,376.00
568-472	3.0" - 3.5"			\$1,750.00	\$1,400.00
568-473	3.5" - 4.0"			\$1,750.00	\$1,400.00
568-474	4.0" - 4.5"			\$1,830.00	\$1,464.00
568-475	4.5" - 5.0"			\$1,930.00	\$1,544.00

Technical Data

Resolution: 0.001mm or 0.00005 in/0.001mm
 Display: LCD
 Response speed: Infinite
 Battery: SR44 (1 pc), **938882**, for initial operational checks (standard accessory)
 Battery life: Approx. 5,000 hours in continuous use
 Scale type: Electrostatic capacitance absolute encoder

Functions

GO/NO-GO judgment, GO/NO-GO judgment zoom, 2-Point Preset, Zero-setting, Data hold, Error alarm, Low battery voltage alert, Data output, Function Lock, 330° rotary display, inch/mm conversion (inch/mm models)

Complete Unit Gage Sets: includes several individual gages to cover the overall size range of the set

Order No	Overall Range	Range of Individual Gages	Setting Rings	List	Promo
568-965	0.275" - 0.5"	0.275-0.35", 0.35-0.425", 0.425-0.5"	0.35" DIA., 0.425" DIA.	\$5,010.00	\$4,008.00
568-966	0.5" - 1"	0.5-0.65", 0.65-0.8", 0.8-1"	0.65" DIA., 0.8" DIA.	\$5,230.00	\$4,184.00
568-967	1" - 2"	1-1.2", 1.2-1.6", 1.6-2"	1.2" DIA., 1.6" DIA.	\$5,460.00	\$4,368.00
568-968	2" - 3"	2-2.5", 2.5-3"	2.5" DIA.	\$3,910.00	\$3,128.00
568-969	3" - 4"	3-3.5", 3.5-4"	3.5" DIA.	\$4,340.00	\$3,472.00



Complete-Unit Set

Interchangeable-Head Sets

Order No	Overall Range	Range of Individual Gages	Setting Rings	List	Promo
568-928	0.275" - 0.5"	0.275-0.35", 0.35-0.425", 0.425-0.5"	0.35" DIA., 0.425" DIA.	\$2,230.00	\$1,784.00
568-929	0.5" - 1"	0.5-0.65", 0.65-0.8", 0.8-1"	0.65" DIA., 0.8" DIA.	\$2,530.00	\$2,024.00
568-930	1" - 2"	1-1.2", 1.2-1.6", 1.6-2"	1.2" DIA., 1.6" DIA.	\$3,080.00	\$2,464.00
568-936	2" - 4"	2-2.5", 2.5-3", 3-3.5", 3.5-4"	2.5" DIA., 3.5" DIA.	\$4,440.00	\$3,552.00



Interchangeable-Head Set

includes one digital display unit with several interchangeable measuring heads (and adapters as required) to cover the total size range plus one extension rod

Prices effective June 1 through August 31, 2020

Height Gages



*Complimentary ground shipping for the 48 contiguous United States. Offer applies to orders placed June 1 through August 31, 2020. Mitutoyo America Corporation reserves the right to change or discontinue this offer at any time. This offer is void wherever prohibited or restricted by law. No cash value. For Alaska and Hawaii special rates apply. Contact us for details.

Complimentary shipping cannot be applied toward previously placed orders. Orders may only be shipped to a single address. If customer returns product, they are responsible for the shipping cost. Refer to our terms and conditions for further details.

Linear Height LH-600E

The Mitutoyo Linear Height LH-600E offers advanced performance for reliable and easy 2D measurement.

Measuring Range (stroke) 0–38" (24") / 0–972mm (600mm)

- > 0.1µm/1µinch resolution.
- > Excellent accuracy of (1.1+0.6L/600)µm with 0.4µm repeatability.
- > Perpendicularity of 5µm and straightness of 4µm are guaranteed.
- > Pneumatic full/semi-floating system.
- > One-key operation for running a semi-automatic measurement.



SAVE 10%



5.7" color LCD

MeasurLink ENABLED
Data Management Software by Mitutoyo

Complimentary Accredited Calibration* (A2LA 0750.01)

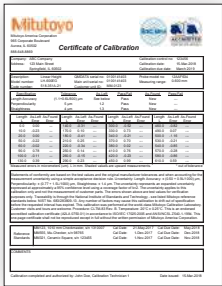

*Complimentary accredited calibration applies to orders placed June 1 through August 31, 2020. This offer is void wherever prohibited or restricted by law. No cash value. Complimentary accredited calibration will be conducted prior to unit shipping and cannot be applied toward previously placed orders. Refer to our terms and conditions for further details.

**Complimentary ground shipping for the 48 contiguous United States. Offer applies to orders placed June 1 through August 31, 2020. This offer is void wherever prohibited or restricted by law. No cash value. For Alaska and Hawaii special rates apply. Contact us for details. Orders may only be shipped to a single address. If customer returns product, they are responsible for the shipping cost. Refer to our terms and conditions for further details.



Promo Price
\$7,632

518-351A-21

Order No.
PROMO027

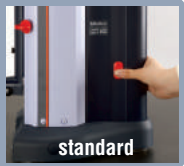

standard

Promo Price
\$8,091

518-352A-21

Order No.
PROMO028



with power grip

High-Performance Height Gage QM-Height Series



- > High-resolution ABSOLUTE linear encoder for position detection.
- > High-accuracy: $\pm(2.4 + 2.1L / 600)\mu\text{m}$.
- > Pneumatic flotation system / positioning grip allows for smooth movement along surface plate (select models).
- > Large, stationary display panel with user-friendly icon control keys and go/no-go LED indicator.
- > Digital and USB output: Supports Mitutoyo wireless SPC output.
- > Fully compatible with existing Mitutoyo Digimatic peripherals (SPC cables, U-Wave wireless transmitters, multiplexers, etc.).
- > **Battery life of 1200 hours in continuous use with four AA batteries, an improvement from 300 hours.**
- > LEDs are activated at the time of tolerance judgment: green for Go, red for +NG, and orange for -NG. -NG, GO and +NG also appear on the LCD.



MeasurLink ENABLED
Data Management Software by Mitutoyo



64PKA129B
518-245



64PKA130B
518-247



Order No.	Range	Resolution	Remarks	List	Promo
64PKA094B	0 - 14" / 0 - 350mm	0.001mm / 0.0005mm	Pneumatic Flotation System	\$3,990.00	\$3,591.00
64PKA095B	0 - 24" / 0 - 600mm			\$4,490.00	\$4,041.00
64PKA129B	0 - 14" / 0 - 350mm	/ .00005" / .0001"	Pneumatic Flotation System	\$4,490.00	\$4,041.00
64PKA130B	0 - 24" / 0 - 600mm			\$4,990.00	\$4,491.00

www.mitutoyo.com

Digimatic Height Gages

Now with higher resolution (.0002"/.0005")



- > Heavy duty, multi-function type.*
- > Carbide-tipped long scriber is provided.
- > Rigid construction ensures repeatable measurement.
- > Switchable resolution.
- > Optional bi-directional touch probe. (192-008)*

- > Coarse/fine feed switching.
- > SPC data output.
- > ABS and INC modes.
- > Two-value preset memory.
- > Data/hold.
- > Inch/mm conversion.

20% OFF



192-670-10

Order No.	Range	Resolution	Accuracy	List	Promo
192-670-10*	0-12"/0-300mm	.0005" (0.01mm) [.0002" (0.005mm) Switchable]	±001"	\$1,820.00	\$1,456.00
192-671-10*	0-18"/0-450mm		±0015"	\$2,350.00	\$1,880.00
192-672-10*	0-24"/0-600mm		±0015"	\$3,010.00	\$2,408.00
192-673-10*	0-40"/0-1000mm		±0025"	\$5,640.00	\$4,512.00
192-630-10	0-12"/0-300mm		±001"	\$1,590.00	\$1,272.00
192-631-10	0-18"/0-450mm		±0015"	\$2,170.00	\$1,736.00
192-632-10	0-24"/0-600mm		±0015"	\$2,770.00	\$2,216.00
192-633-10	0-40"/0-1000mm		±0025"	\$5,230.00	\$4,184.00

MeasurLink ENABLED
Data Management Software by Mitutoyo



Surftest SJ-210 Packages

- > The 2.4" color graphic, back-lit LCD provides excellent readability.
- > Replace Skid system offers user-friendly and intuitive menu navigation.
- > Performs roughness analysis conforming to various international standards (EN ISO, VDA, ANSI, JIS) and customized settings.
- > Calculation results, assessed profiles, bearing and amplitude curves can be displayed.
- > Supports 16 languages.



MeasurLink ENABLED
Data Management Software by Mitutoyo



178-561-02A

Order No	Description	List	Promo
64PKA226	Calibration Package	\$2,946.00	\$2,430.00
178-561-02A	SJ-210 IN 4mN (Standard Drive Unit)		
178-390	FREE EXTRA DETECTOR		
C178-602	50% off Calibrated specimen		



178-390



Order No	Description	List	Promo
64PKA227	Data Collection Package	\$3,259.00	\$2,760.00
178-561-02A	SJ-210 IN 4mN (Standard Drive Unit)		
02AZD730G	U-WAVE TRANSMITTER		
02AZD790D	U-WAVE connecting cable D		
02AZD810D	FREE U-WAVE RECEIVER		



02AZD730G



02AZD810D



02AZD790D

Order No	Description	List	Promo
64PKA228	Height Gage Package	\$3,572.00	\$2,890.00
178-561-02A	SJ-210 IN 4mN (Standard Drive Unit)		
12AAA233	Height gage adapter (Inch)		
192-150	12" Dial height gage		



12AAA233



192-150



Prices effective June 1 through August 31, 2020



Bench Top

Laser Scan Micrometer LSM-9506

- > Integrated display and measuring unit in one unit.
- > Statistical calculation mode.
- > RS-232C output, I/O interface and SPC output interface are standard.
- > Accuracy: .0001"

MeasurLink ENABLED
Data Management Software by Mitutoyo



544-116-1A

Order Number	Range	Resolution	List	Promo
544-116-1A	.020" - 2.36"/0.5mm - 60mm	.000002" - .005"/0.00005 - 0.1mm	\$8,940.00	\$8,046.00

QUICKTOOL* is a free, downloadable software that makes programming the laser quick and easy.
*For use with customer-supplied PC and optional RS-232C cable.

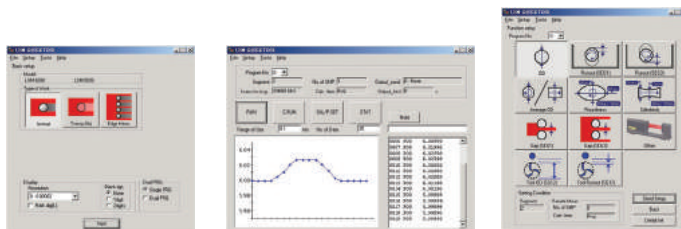

High-Accuracy Non-Contact Measuring Systems

- > Excellent accuracy: down to +/- 12 μinches
- > High-speed scanning capable: 3,200 scans per second.
- > Various ranges available for selecting the best laser for your application.
- > Statistical calculation mode.
- > Memory function allows storage of up to 100 programs.
- > Standard RS-232C output and I/O interface. Optional Digimatic output.



**FREE
LSM 6200
Display!**



UP TO 35% OFF

Order No	Model	Range Inch	Range mm	Repeatability	Accuracy	Scanning Rate	List	Promo
64PKA117	LSM-500S	.0002" - .08"	0.005~2mm	±0.03μm	±0.3μm	3,200 scans/sec	\$10,370.00	\$7,090.00
64PKA118	LSM-501S	.002" - .4"	0.05~10mm	±0.04μm	±0.5μm [†]	3,200 scans/sec	\$9,330.00	\$6,050.00
64PKA119	LSM-503S	.012" - 1.18"	0.3~30mm	±0.11μm	±1.0μm [†]	3,200 scans/sec	\$10,110.00	\$6,830.00
64PKA120	LSM-506S	.04" - 2.36"	1~60mm	±0.36μm	±3μm [†]	3,200 scans/sec	\$11,480.00	\$8,200.00
64PKA121	LSM-512S	.04" - 4.72"	1~120mm	±0.85μm	±6μm [†]	3,200 scans/sec	\$17,680.00	\$14,400.00
64PKA122	LSM-516S	.04" - 6.30"	1~160mm	±1.4μm	±7μm [†]	3,200 scans/sec	\$28,480.00	\$25,200.00

[†] Accuracy over entire range. Higher accuracies are possible over smaller ranges.

MeasurLink ENABLED
Data Management Software by Mitutoyo



QUICKTOOL* is free downloadable software that makes programming the LSM-6200 quick and easy.
*For use with customer-supplied PC and optional RS-232C cable.

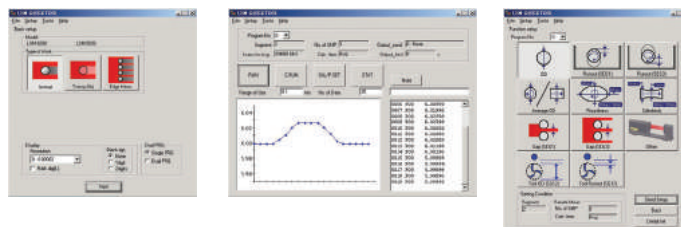

Rockwell and Rockwell Superficial Hardness Tester

With Real-Time Electronic Test Force Control

- > Closed-loop control of testing forces.
- > Initial and Total test forces (loads) are applied with unparalleled accuracy and repeatability.
- > Extended indenter arm reaches inside diameters and hard-to-reach surfaces at eye level, allowing the operator to easily see where the indenter accesses small or hard-to-reach parts.
- > Automatic cycle start after initial set point is reached.
- > Continuous test mode for automatic testing of like sized parts.
- > Touch-screen operation with color LCD.
- > All hardness parameters set automatically via the touch screen.
- > Cylindrical and spherical surface corrections.
- > Auto conversion to most common hardness scales or tensile strength.



MeasurLink ENABLED
Data Management Software by Mitutoyo



HR-530
(810-237)



Order No.	810-237	
Model	HR-530	
Hardness testing methods	Rockwell/Rockwell Superficial/Brinell/Plastics hardness	
Initial test force (N)	29.42N (3kgf), 98.07N (10kgf)	
Test force (N)	Rockwell Superficial	147.1N (15kgf), 294.2N (30kgf), 441.3N (45kgf)
	Rockwell	588.4N (60kgf), 980.7N (100kgf), 1471N (150kgf)
	Light Force Brinell	61.29 (6.25kgf), 98.07 (10kgf), 153.2 (15.625kgf), 245.2 (25kgf), 294.2 (30kgf), 306.5 (31.25kgf), 612.9 (62.5kgf), 980.7 (100kgf), 1226 (125kgf), 1839 (187.5kgf)
External data output	RS-232C, digimatic, USB2.0	
External dimensions	Main unit	9.84" x 26.38" x 23.82" (250(W)x667(D)x621(H) mm) 11.8" x 26.2" x 30.1" (300(W)x667(D)x766(H) mm)
	Touch-panel display	191(W)x147(D)x71(H) mm
Mass	Approx. 60 kg	
List	\$13,500.00	
Promo	\$12,825.00	

Function: Touch-screen type

- Touch-screen operation with a back-lit LCD graphic display.
- Remote selection of the test force linked to the hardness scale selection.
- Choice of language: English, German, French, Spanish, Italian and Japanese.
- Cylindrical and spherical surface compensation.
- Data offset.
- Conversion to other hardness scales.
- Powerful statistical processing with flexible data point editing and 1024 data memory.
- Measured data editing.
- Go/no-go tolerance judgment.
- Statistical processing, histogram and x-R chart.

Durometers (Digital and Analog) For Rubber and Plastic Hardness Testing

- > Durometers are suitable for testing natural rubber, neoprene, polyesters, PVC, leather, Thiokol, nitril, wax, vinyl, cellulose acetates, glass, polystyrol and other materials.



Compact Dial
811-336-10



Compact Digital
811-336-10

MeasurLink ENABLED
Data Management Software by Mitutoyo



Order No	Model	Scale	Display	Graduation	Range	Indenter	List	Promo
811-335-10	HH-335	Shore A	Analog	1.0	10~90	Blunt Taper	\$599.00	\$569.05
811-336-10	HH-336	Shore A	Digital	0.5	10~90	Blunt Taper	\$1,280.00	\$1,216.00
811-337-10	HH-337	Shore D	Analog	1.0	20~90	Sharp Point	\$599.00	\$569.05
811-338-10	HH-338	Shore D	Digital	0.5	20~90	Sharp Point	\$1,280.00	\$1,216.00

HH-411 Hardmatic

Rebound Leeb portable hardness tester featuring reproducibility and ease of operation on large parts. It is lightweight and can be carried into the shop or out in the field.

MeasurLink ENABLED
Data Management Software by Mitutoyo

Order No.	Type	List	Promo
810-298-10	HH-411 Hardmatic	\$3,990.00	\$3,790.50





MF Measuring Microscopes

- > Observation with a crisp and high-resolution erect image and a wide field of view.
- > Measuring accuracy that is highest in its class (and conforms to JIS B 7153).
- > Included 3x objective and binocular eyetube.
- > Illumination unit (reflected/transmitted) selectable from a high-intensity LED.
- > Quick-release mechanism useful for moving the stage quickly when measuring workpieces that are large in size or quantity.
- > Dedicated camera port allows for simultaneous eyepiece and digital observation.

Model No. (XY stage size)	MF-A1010D
XY stage travel range	4 x 4" / 100 x 100mm
Z-axis travel range	6" / 150mm
Focusing method	Manual focusing (Coarse focusing: 30mm/rev., Fine focusing: 0.2mm/rev.)
Measurement method	Linear encoder (2-axis model: X / Y-axis, 3-axis model: X / Y / Z-axis)
Resolution (switchable)	.0001" / .00005" / .00001" (0.001mm / 0.0005mm / 0.0001mm)
Measuring accuracy (at 20°C)	XY-axis: (2.2+0.02L)µm, L = Measuring length (mm) when not loaded, JIS B 7153
Indication accuracy (at 20°C)	Z-axis: (5+0.04L)µm, L = Measuring length (mm), (MF-B type)
Floating function	X and Y axes with Quick-release mechanism
XY stage top size	11 x 11" / 280 x 280mm
Effective glass size	7 x 7" / 180 x 180mm
Max. stage loading	22lbs / 10kg
Max. workpiece height	6" / 150mm

10% OFF All MF & MF-U MICROSCOPES



MeasurLink ENABLED
Data Management Software by Mitutoyo



176-861-10

Sample Package

Order No	Description	List	Promo
64PKA092A	MF-A1010D Package		
176-861-10	MF-A1010D	\$18,960.00	\$17,064.00
176-445A	LED Illumination unit (MF)		
176-393	Binocular Tube		

TM Toolmakers' Microscopes



- > Adjustable illumination intensity.
- > Angle measurement is performed easily by turning the angle scale disc to align the cross-hair reticle with the workpiece image.
- > Includes standard accessories create an overall magnification of 30X. Magnifications can be changed from 20 - 200X by using optional objectives and/or eyepieces.
- > .000050" resolution digimatic micrometer heads included.



Conventional illumination



Newly designed LED illumination

MeasurLink ENABLED
Data Management Software by Mitutoyo

10% OFF

**TM-A505B
176-820A**



Model No.	TM-A505B	TM-A1005B
Order No.	176-820A	176-821A
Eyepiece	Standard accessory: 15X (field number: 13), Options: 10X, 20X	
Objective lens	Standard accessory: 2X, Options: 5X, 10X	
Microscope head	Maximum height of workpiece	4.53" / 115mm
		4.21" / 107mm
Illumination unit	Transmitted illumination	Stepless brightness adjustment, White LED light source, with green filter
	Surface illumination	Oblique single-source type, Stepless brightness adjustment, White LED light source
Cross-travel stage	Measuring range	2" x 2" / 50x50mm
	Usable area of the stage glass	3.8" x 3.8" / 96x96mm
	Maximum stage glass loading	6" x 3.8" / 154x96mm
Linear measurement method	11 lbs. / 5kg Micrometer heads included	
	List	\$5,590.00
	Promo	\$5,031.00
		\$7,290.00
		\$6,561.00

Trinocular Stereo Microscope MSM-414TL

- > Continuous 1X - 4X magnification.
- > Image always in focus throughout zoom range.
- > Crisp, erect images with high resolution and excellent stereoscopic effect.
- > Stereo-tube can be rotated a full 360° for viewing at any angle.
- > Bilateral zoom control knob adds convenience and increases operator efficiency.
- > Diopter adjustment for both eyepieces.

Model	MSM-414TL
Order No.	377-974A
Optical tube	Trinocular
Total magnification	10X - 40X
Eyeiece	10X (377-016)
Objective	1X - 4X
Working distance	80mm
Field of view	20mm - 5mm
Dimensions	H=13.2" x W=6.7" x D=9.3"
Mass	13.2 lbs (6kg)



Order No.	Description	List	Promo
377-974A	MSM-414TL Stereo Microscope	\$1,380.00	\$1,311.00
377-481	C-mount Video Adapter for MSM-414TL	\$53.85	
64AAB526	Digital camera w/software 1080, 2.0 Mega Pixels, HDMI/USB	\$1,250.00	



Camera with software for digital viewing

Mitutoyo's Digital Readout Packages

Mounting Hardware Included on all machine retrofit packages

All DRO Packages Include:

- > KA-200 Counter
- > KA-200 Counter tray/arm kit
- > High Resolution Linear Scales (down to .0001" or better!)
- > Bracket Kit(s)



SAVE
\$200
PER PACKAGE

MeasurLink ENABLED
Data Management Software by Mitutoyo

Package Part No.	Description	X Travel	Y Travel	Z Travel	X Axis Type	Y Axis Type	Z Axis Type	List	Promo
64PKA058A	12" X 30" DRO Mill Package	30"	12"		AT715	AT715		\$1,490.00	\$1,290.00
64PKA059A	12" X 36" DRO Mill Package	36"	12"		AT715	AT715		\$1,490.00	\$1,290.00
64PKA060A	14" X 30" DRO Mill Package	30"	14"		AT715	AT715		\$1,490.00	\$1,290.00
64PKA062A	16" X 36" DRO Mill Package	36"	16"		AT715	AT715		\$1,490.00	\$1,290.00
64PKA063A	16" X 40" DRO Mill Package	40"	16"		AT715	AT715		\$1,490.00	\$1,290.00
64PKA035A	6" X 28" Lathe Package	6"		28"	AT116		AT715	\$1,450.00	\$1,250.00
64PKA039A	8" X 40" Lathe Package	8"		40"	AT116		AT715	\$1,450.00	\$1,250.00
64PKA042A	10" X 40" Lathe Package	10"		40"	AT116		AT715	\$1,450.00	\$1,250.00
64PKA046A	12" X 40" Lathe Package	12"		40"	AT116		AT715	\$1,450.00	\$1,250.00
64PKA050A	12" X 60" Lathe Package	12"		60"	AT116		AT715	\$1,650.00	\$1,450.00
64PKA052A	14" X 40" Lathe Package	14"		40"	AT116		AT715	\$1,450.00	\$1,250.00
64PKA057A	16" X 60" Lathe Package	16"		60"	AT116		AT715	\$1,650.00	\$1,450.00
64PKA026A	6" X 12" Grinder Package	6"		12"	AT116		AT116	\$1,620.00	\$1,420.00
64PKA028A	8" X 12" Grinder Package	8"		12"	AT116		AT116	\$1,620.00	\$1,420.00
64PKA029A	8" X 14" Grinder Package	8"		14"	AT116		AT116	\$1,620.00	\$1,420.00

Other packages and kits are available for mills, lathes, grinders and custom machines and applications. Contact your local distributor for details.



Digimatic Quill Kit

Easy Installation, Fits Most Vertical Knee Mills

- > Easy-to-read LCD with resolution of .0005"/0.01mm. 0-6" travel.
- > Push-button controls for inch/mm, Zero-Set and On/Off.
- > Powered by a single SR-44 Battery which lasts about 1 year with normal use.
- > SPC Output for data transmission to data processors or a remote display.
- > ABS encoder.

MeasurLink ENABLED
Data Management Software by Mitutoyo

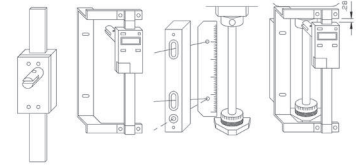
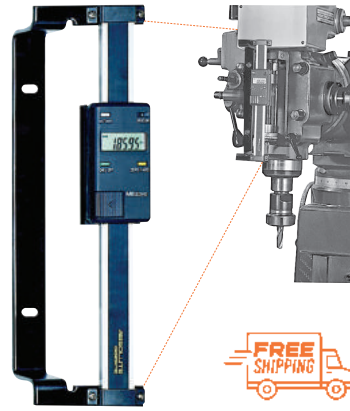

The Mitutoyo Quill Kit mounted on a vertical mill.

ABSOLUTE™

Order No.	Description	List	Promo
053906B	Digimatic Quill Kit complete with brackets & scale for Bridgeport Type machines.	\$310.00	\$294.50



ABSOLUTE Digimatic Scale Units

- > The Origin key allows setting of an absolute zero point to be used as reference in subsequent measurements. Once set, the ABS Digimatic Scale Unit is ready to show its true position whenever turned on, rather than 0.00" as with standard models.
- > The Zero/ABS key allows the display to be zero-set at any slider position along the beam for incremental comparison measurements. This key will also allow return to the absolute coordinate with a display of the true position from the origin point.
- > No rack, no pinion, no glass scale. Digimatic scale unit is safely embedded in the hardened stainless steel blade.
- > Horizontal or vertical face according to the scale mounting direction.
- > Multi-function types with diameter displaying function are also available for lathes. (Contact Mitutoyo.)
- > All units come with two mounting brackets, each located at either end of the scale.
- > With SPC data output.



ABSOLUTE™

Order No	Model	Range	Accuracy	Resolution	Type	List	Promo
572-210-30	SD-4"DX	0-4" / 0-100mm	.001" / 0.03mm	.0005" / 0.01mm	Horizontal single-function	\$235.00	\$223.25
572-211-30	SD-6"DX	0-6" / 0-150mm	.001" / 0.03mm	.0005" / 0.01mm	Horizontal single-function	\$249.00	\$236.55
572-212-30	SD-8"DX	0-8" / 0-200mm	.001" / 0.03mm	.0005" / 0.01mm	Horizontal single-function	\$290.00	\$275.50
572-213-10	SD-12"D	0-12" / 0-300mm	.002" / 0.04mm	.0005" / 0.01mm	Horizontal single-function	\$559.00	\$531.05
572-310-10	SDV-6"D	0-4" / 0-100mm	.001" / 0.03mm	.0005" / 0.01mm	Vertical single function	\$260.00	\$247.00
572-311-10	SDV-6"D	0-6" / 0-150mm	.001" / 0.03mm	.0005" / 0.01mm	Vertical single-function	\$276.00	\$262.20
572-312-10	SDV-8"D	0-8" / 0-200mm	.001" / 0.03mm	.0005" / 0.01mm	Vertical single function	\$320.00	\$304.00
572-313-10	SDV-12"D	0-12" / 0-300mm	.002" / 0.04mm	.0005" / 0.01mm	Vertical single function	\$616.00	\$585.20



MeasurLink ENABLED
Data Management Software by Mitutoyo

Applications

Machine table position

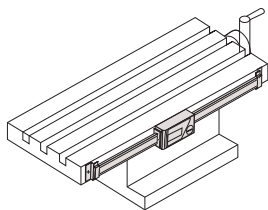

Drilling machine stroke position

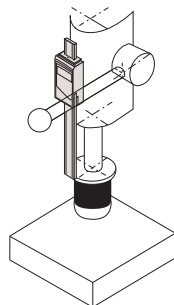

Focus setting on optical instruments

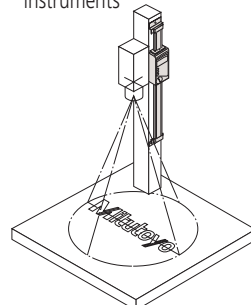

Special Applications

As a measurement jig for outdoor use (SD-G)

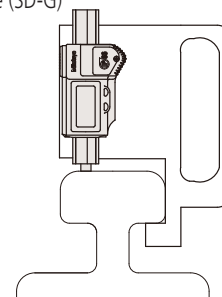

Detector head mechanism

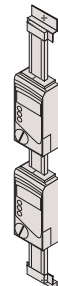

PJ-A3000 Vertical Profile Projector

- > A series of midsize profile projectors featuring bright, 12.40" (315mm) diameter screens and easy-to-operate XY measurement tables.
- > A floating table makes measuring quick and easy.
- > Built-in, easy-to-read digital counters are located near the projection screen, therefore minimizing strain associated with excessive movement.
- > For edge-sensing capabilities, order the Optoeye-200, part number 332-151.



PJ-A3010F-200

MeasurLink ENABLED
Data Management Software by Mitutoyo

Order No.	Description	XY Travel	List
302-701A	PJ-A3010F-200	8" x 4"	\$13,600.00
302-702A	PJ-A3005F-150	6" x 2"	\$12,000.00
302-703A	PJ-A3010F-100	4" x 4"	\$10,800.00
302-704A	PJ-A3005D-50	2" x 2"	\$8,890.00

PJ-H30 Vertical Profile Projector

- > Newly designed optical system with high NA lenses provides drastically brighter and clearer screen images during surface illumination.
- > The three-lens mounting turret includes a 10X lens as standard. Four types of projection lenses (5X, 20X, 50X, 100X) are available.

MeasurLink ENABLED
Data Management Software by Mitutoyo



PJ-H30A3017B

Order No.	Description	XY Travel	List
303-712-1A	PJ-H30A1010B	4 x 4" /100x100mm	\$23,100.00
303-713-1A	PJ-H30A2010B	8 x 4" /200x100mm	\$28,200.00
303-714-1A	PJ-H30A2017B	8 x 6.7" /200x170mm	\$33,300.00
303-715-1A	PJ-H30A3017B	12 x 6.7" /300x170mm	\$38,400.00
* 303-732-1A	PJ-H30D1010B	4 x 4" /100x100mm	\$28,200.00
* 303-733-1A	PJ-H30D2010B	8 x 4" /200x100mm	\$33,300.00
* 303-734-1A	PJ-H30D2017B	8 x 6.7" /200x170mm	\$38,400.00
* 303-735-1A	PJ-H30D3017B	12 x 6.7" /300x170mm	\$43,600.00

* Built-in edge detection and power focus

Prices Effective June 1 through August 31, 2020

PV-5110 Profile Projector

- > Large 500mm screen.
- > Floor model uses a downward illumination system.
- > Digital readout protractor screen (including zero-setting, ABS/INC coordinate switching functions) for easy and error-free angle measurement.
- > Angled screen allows projected images to be easily traced or compared with a template.
- > The oblique surface illumination system provides clear and bright images, allowing easy inspection of non-reflective workpieces such as plastic parts or printed materials.
- > 200 x 100mm (8 x 4") XY travel
- > 10x projection lens set
- > Surface illumination unit
- > Counter stand for KA counter
- > Power cord, halogen bulb, fuse, grounding wire, allen wrench, vinyl cover



PV-5110

MeasurLink ENABLED
Data Management Software by Mitutoyo

Order No.	Description	List
304-919A	Profile Projector PV-5110	\$19,500.00

Optional Accessories

Order No.	Description	List
264-156A	QM-Data200 (Arm-Mount Model)	\$2,720.00
332-151	Optoeye-200	\$1,650.00
12AAE672	Attachment (B) for Optoeye-200 for PV-5110	\$58.65
12AAE671	Attachment (A) for Optoeye-200 for PJ-A, PJ-H	\$40.80
174-183A	KA 200 Counter	\$587.00
64PMI167	STAND FOR PJ-A3000, 24.4"x20"x32" (CHARCOAL GRAY, RAL7016 RTM)	\$688.00
172-269	MACHINE STAND FOR PJ-H SERIES	\$1,660.00

*Attachment A/B and 332-151 (Optoeye-200 Edge detection system) must be sold together as an option

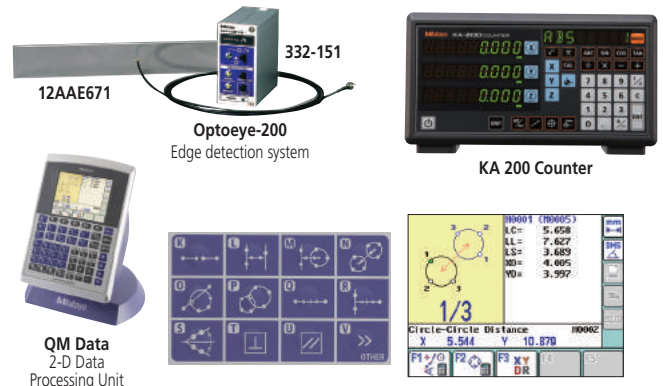



PH-3515 Profile Projector and 2D Processor Packages

Heavy-Duty, Bench-Top Model with Horizontal Optical System featuring touch screen M2 geometric measuring display

- > ø14" Screen, Horizontal Projector.
- > 10" x 6" Travel T Slot table for accessories.
- > Linear Glass Scales for accurate measurement Profile and Fiber Optic Surface Illumination.
- > Easy to use all-in-one PC Touch Screen.
- > M2 Geometric 2D Measurement Software.
- > Optional Edge Detection.
- > Digital built-in angle counter.

MeasurLink ENABLED
Data Management Software by Mitutoyo

Order No.	Description	List
64PKA088A*	PH-3515F Profile Projector w/QM Data (Arm Mount)	\$13,500.00
64PKA089B	PH-3515F Profile Projector w/KA counter & tray	\$11,600.00
64AAB176	PH-3515 Stand (optional)	\$687.00
64PKA165	PH-3515 PROFILE PROJECTOR - WITH OPTICAL EDGE DETECTION AND TOUCH SCREEN M2 GEOMETRIC DISPLAY	\$15,900.00
64PKA166	PH-3515 PROFILE PROJECTOR - WITH TOUCH SCREEN M2 GEOMETRIC DISPLAY	\$14,500.00

(Includes installation and A2LA accredited calibration)

*12AAE671 and 332-151 (Optoeye-200 Edge detection system) must be sold together as an option



TRADE IN TRADE UP

Money for Your Old Machine - Exchange your old machine for **up to \$1,500** toward the purchase of a new projector with Mitutoyo's trade-in program.

The trade-in allowance is determined by the purchase price of a new model and will be deducted from the price of a new machine order.

Eligible machines for trade-in:

- ✓ Previous Generation Mitutoyo Horizontal Projectors
- ✓ Previous Generation Mitutoyo Vertical Projectors
- ✓ Non-Mitutoyo Horizontal Projectors
- ✓ Non-Mitutoyo Vertical Projectors

TRADE UP Program Includes:

- FREE Shipping***
- FREE Installation**
- FREE A2LA Calibration**



LEARN MORE



<https://www.mitutoyo.com/profileprojector2020>



Mitutoyo America Corporation

965 Corporate Boulevard
Aurora, Illinois 60502
1-888-648-8869

SUMMER PROMO 2020

PRECISION TOOLS & INSTRUMENTS

Mitutoyo products are sold only through authorized distributors. To find an authorized Mitutoyo distributor near you, visit: www.mitutoyo.com/distributor-locator/

2020 Tradeshow Schedule:

IMTS - Sep 14 - 19, 2020 - Chicago, IL - Booth #135215



Note: All information regarding our products, and in particular the illustrations, drawings, dimensional and performance data contained in this printed matter as well as other technical data are to be regarded as approximate average values. We therefore reserve the right to make changes to the corresponding designs. The stated standards, similar technical regulations, descriptions and illustrations of the products were valid at the time of printing. In addition, the latest applicable version of our General Trading Conditions will apply. Only quotations submitted by ourselves may be regarded as definitive. Specifications are subject to change without notice.

Mitutoyo products are subject to US Export Administration Regulations (EAR). Re-export or relocation of our products may require prior approval by an appropriate governing authority.

Trademarks and Registrations

Designations used by companies to distinguish their products are often claimed as trademarks. In all instances where Mitutoyo America Corporation is aware of a claim, the product names appear in initial capital or all capital letters. The appropriate companies should be contacted for more complete trademark and registration information.

We reserve the right to change specifications and prices without notice. Not valid with any other offer or promotion, previous purchases. Please refer to terms and conditions for additional information. Domestic U.S. orders only.

© 2020 Mitutoyo America Corporation

0520-01 • FOR WEB ONLY • May 2020



SUMMER PROMO 2020

PRECISION TOOLS & INSTRUMENTS

Effective June 1 through August 31, 2020

SUMMER PROMO 2020

MeasurLink[®] ENABLED

Data Management Software by Mitutoyo

